

# Xelos

TV

Xelos 40 LED,  
Xelos 32 LED



Operating instructions

**LOEWE.**

# Overview of the most important functions

## Set operating mode



TV operation



Radio operation (standard assignment)  
The assignment of the AUDIO button can be changed (see page 102).

## On/Off of the television set



On/Off device in standby  
(Main switch must be turned on)

## Selecting stations



**OK** Call station overview and with  
◀ ▶ ▲ ▼ Select station



or  
**P+ / P-** Programme +/-



or  
Select station with numeric buttons

## Sound



**V+ / V-** Volume up/down



Sound on/off

## Colour key function during TV operation



**Red button:** Freeze frame on/off;  
Call DR archive <sup>(1)</sup>

**Green button:** Teletext functions

**Yellow button:** Last selected station

**Blue button:** Programme information

## Colour key function during radio operation



**Red button:** On/Off screen

**Yellow button:** Last selecting station

## Button functions



Call MediaPortal,  
select operating mode or function.  
(e.g. Index)



with on-screen display: Info display,  
info text appropriate to the content that can assist you  
further, should you have any questions about your TV  
device;

without on-screen display: Access status display,  
with status display open and repeatedly pressing  
programme information (if available)



Open DR archive <sup>(1)</sup> / Timer list  
Press button twice in quick succession:  
Show / hide time permanently



Adjust picture format



On/Off PIP (picture in picture)



On/Off EPG (Electronic Programme Guide)



On/Off teletext



Call TV menu,  
carry out settings



With opened menu: Exit menu;  
Terminate inserts

<sup>(1)</sup> Only if an external hard disc is connected (USB Recording).

# Remote control – TV functions

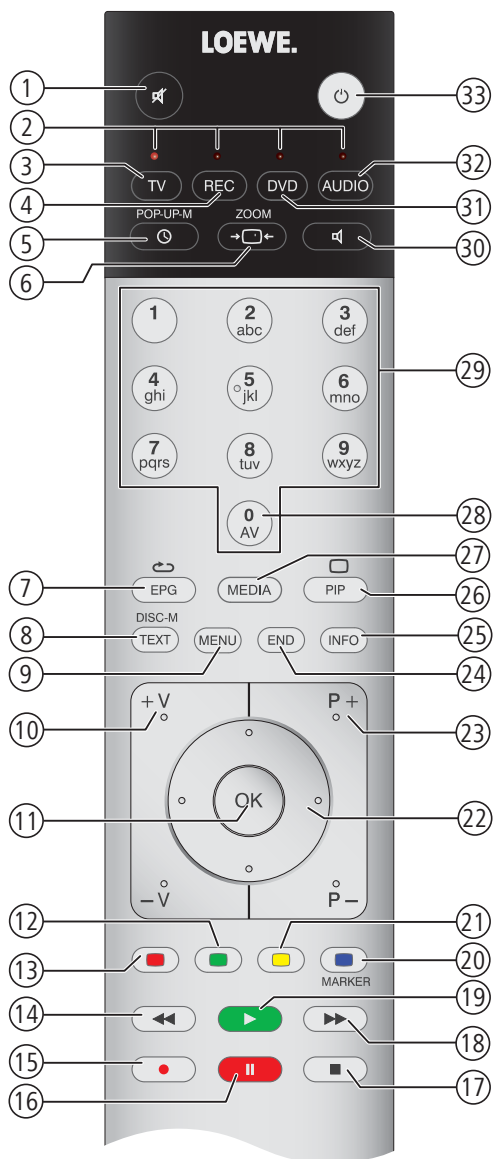

- ① Sound off/on ..... (page 31)
- ② LED display for current operating mode ..... (page 102)
- ③ Switch over to TV mode ..... (page 19; 102)
- ④ Switch over to operate recorder<sup>2</sup> ..... (page 102)
- ⑤ DR archive<sup>1</sup> / Timer list on/off ..... (page 78; 100)
- ⑥ Set picture format ..... (page 34)
- ⑦ Electronic Programme Guide on/off ..... (page 45)
- ⑧ Teletext on/off ..... (page 47)
- ⑨ Menu on/off ..... (page 12)
- ⑩ **V+/V-** Volume louder/quieter ..... (page 31)
- ⑪ Station list on ..... (page 29)  
in the menu: Confirm/call ..... (page 12)
- ⑫ Green button: Teletext functions ..... (page 35)
- ⑬ Red button: Freeze on/off / Call DR archive<sup>1</sup> ..... (page 35)
- ⑭ Select station down / Jump<sup>1</sup> / Rewind<sup>1</sup> ..... (page 79)
- ⑮ Direct recording
- ⑯ Still frame on/off / timeshift television<sup>1</sup> ..... (page 76)
- ⑰ Still frame on / End timeshift<sup>1</sup> / End archive playback<sup>1</sup> ..... (page 76)
- ⑱ Select station up / Jump<sup>1</sup> / Fast forward<sup>1</sup> ..... (page 79)
- ⑲ Still frame off / Set bookmark<sup>1</sup> ..... (page 78)
- ⑳ Blue button: Programme info on/off ..... (page 35)
- ㉑ Yellow button: Previous station ..... (page 35)
- ㉒ In the menu / Lists: Select/Set ..... (page 12)
- ㉓ **P+/P-** Select Station up/down ..... (page 29)
- ㉔ Close all displays ..... (page 12)
- ㉕ Status display on/off / in the menu: context-relevant Info on/off ..... (page 37; 15)
- ㉖ PIP on/off (picture in picture) ..... (page 43)
- ㉗ MediaPortal on/off ..... (page 14; 56)
- ㉘ AV selection ..... (page 30)
- ㉙ Select station directly; in the menu: Enter numbers or letters ..... (page 29)
- ㉚ Set sound adjustment ..... (page 31)
- ㉛ Switch over to operate DVD player<sup>2</sup> ..... (page 102)
- ㉜ Switch over to radio mode<sup>2</sup> ..... (page 20; 49; 102)
- ㉝ Switch on/off – to standby mode ..... (page 20)

<sup>1</sup> With connected external hard disc, see the Digital Recorder chapter from page 65 onwards.

<sup>2</sup> The assignment of these keys can be changed (see page 102). The description refers to the standard setting.

The key assignment displayed here is valid for the main menu level of the TV set. The key assignment may vary in certain operating modes (see the corresponding chapter in this operating manual).

# Acknowledgements

Loewe Opta GmbH  
Industriestraße 11  
D-96317 Kronach  
www.loewe.de

Printed in Germany  
Date of issue 03/11-1.0 TB/FP  
© Loewe Opta GmbH, Kronach  
ID: 4.10.0

All rights including translation, technical modifications and errors reserved.



# Contents

<b>Overview of the most important functions</b> .....	<b>2</b>	<b>Daily operation</b> .....	<b>29</b>
<b>Remote control – TV functions</b> .....	<b>3</b>	Select station .....	29
<b>Acknowledgements</b> .....	<b>4</b>	Selecting Audio/Video Source .....	30
<b>Welcome</b> .....	<b>7</b>	Adjusting the sound .....	31
Scope of delivery .....	7	Adjusting the picture.....	33
About this operating manual .....	7	Button functions .....	35
<b>For your safety</b> .....	<b>8</b>	Operation without remote control.....	36
<b>Control unit front side of the device</b> .....	<b>10</b>	Status display.....	37
<b>Connections rear side of the device</b> .....	<b>11</b>	<b>Managing stations</b> .....	<b>39</b>
<b>Operating convenience</b> .....	<b>12</b>	TV stations.....	39
General information on menu operation .....	12	Put together / change favourites lists .....	42
Operating convenience with wizards .....	13	<b>Picture in Picture</b> .....	<b>43</b>
Overview of wizards.....	13	Picture in Picture (PIP) .....	43
MediaPortal.....	14	Configure Picture in Picture (PIP) mode .....	44
The index in the TV set.....	15	<b>Electronic Programme Guide</b> .....	<b>45</b>
The info display .....	15	Electronic Programme Guide – EPG .....	45
TV menu – Overview diagram.....	16	Configuring EPG.....	46
Radio menu – Overview diagram.....	17	<b>Teletext</b> .....	<b>47</b>
Other menus – Overview diagram .....	17	Teletext.....	47
<b>Initial installation</b> .....	<b>18</b>	Teletext menu.....	48
Installing the TV set .....	18	Interactive data services .....	49
Set covers .....	18	<b>Digital radio</b> .....	<b>49</b>
Connecting the TV Set .....	18	Radio mode (DVB radio).....	49
Bundling the cables.....	19	EPG – Electronic Programme Guide (radio) .....	50
Preparing the remote control unit.....	19	Audio playback from external devices.....	51
Turning the set on/off.....	20	<b>Other settings</b> .....	<b>52</b>
First installation wizard .....	21	Parental lock.....	52
Positioning/aligning DVB-T antenna .....	28	Timer functions .....	53
		Language .....	53
		On-screen displays .....	54
		Time and date .....	54
		<b>Coded Stations</b> .....	<b>55</b>
		Conditional Access module (CA module) .....	55

# Contents

<b>Media+</b> .....	<b>56</b>	<b>Troubleshooting</b> .....	<b>107</b>
General information on Media+ .....	56	<b>Technical data</b> .....	<b>109</b>
Media menu .....	57	General data .....	109
MediaHome .....	58	Electrical data .....	110
MediaMusic .....	61	Signals via PC IN / HDMI .....	110
MediaPhoto .....	62	Connections (max. equipment) .....	111
MediaVideo .....	63	MediaHome .....	112
<b>Digital Recorder</b> .....	<b>65</b>	<b>Accessories</b> .....	<b>113</b>
About the Digital Recorder system .....	65	Accessories .....	113
Settings .....	68	Upgrade kits / conversion kits / cables .....	114
Archive recording – Direct recording .....	70	Equipment variants .....	115
TV viewing with time shift .....	76	TV set equipment .....	115
Archive playback .....	78	Setup possibilities .....	116
<b>External devices</b> .....	<b>89</b>	<b>Environment</b> .....	<b>117</b>
Connections menu .....	89	<b>Legal notes</b> .....	<b>118</b>
Gaming mode .....	90	<b>Glossary</b> .....	<b>119</b>
Devices to the connections AV/AVS .....	91	<b>Index</b> .....	<b>123</b>
Devices to the HDMI connections .....	93	<b>Service</b> .....	<b>126</b>
Digital Link HD .....	94		
Devices to the PC IN connection .....	95		
Sound components wizard .....	96		
Connecting speaker system .....	97		
Connecting audio amplifiers .....	98		
The direct way to record .....	99		
Timer recording with external devices .....	101		
Serial interface RS-232C (RJ12) (retrofitable) .....	101		
Operating Loewe equipment .....	102		
<b>Software update</b> .....	<b>103</b>		
Basic information .....	103		
USB stick .....	103		
Download .....	103		
Software update .....	103		
<b>Input of characters</b> .....	<b>105</b>		
USB keyboard .....	105		
Button combinations .....	105		
Character table .....	106		

# Welcome

## Thank you

for choosing a Loewe TV set!

Loewe stands for the highest demands in technology, design and user friendliness. This applies equally for TV, video and accessories.

In addition to the elegant design and the many different possible colour combinations and installation possibilities, your Loewe TV set also offers many technological options.

## Loewe Image+

State-of-the-art Full-HD-LCD-displays with LED-Backlight Technology. The advantage of the LED-Backlight is in the reduced energy consumption and high contrast values.

24p films played by a connected HDMI unit can be displayed optimally.

## Loewe Sound+

Loewe Sound+ contains sound processors that are optimally matched to the integrated loudspeakers of the TV set.

## Loewe Media+

You can reach the MediaPortal via the MEDIA button on your remote control, giving you access to all multimedia functions of your TV set.

## Scope of delivery

- LCD TV set
- Mains cable
- Velcro cable ties
- Remote control Assist with two batteries
- TV quick guide

The TV set is delivered ex-factory without speakers. You can configure your own individual speaker system for your TV set to suit your needs. Ask your dealer.

## About this operating manual

For best results regarding safety and the longevity of the set, we recommend you read the chapter **For your Safety** (page 8) before switching it on for the first time.

The functions of the Loewe TV set are largely self-explanatory. However, should you have any questions, the integrated **index** and the **info display** (see page 15) can assist you further.

The index/glossary from page 119 onwards gives explanations of certain terms used in the TV set and the operating manual.

Paragraphs which begin with the symbol  indicate important instructions, tips or conditions for the following settings.

Terms which you will find in the menus or printed on the remote control or TV set are written in **bold** type.

The necessary control elements are shown in the descriptions to the left of the text containing the instructions for action.

In addition to the remote control, a PC keyboard can be connected to one of the USB ports on your TV and then used to control your TV set (see also page 105)



In the operating manual, this symbol indicates places in which the use of a keyboard is particularly advantageous.

Depending on the connected accessory equipment the menus in the TV set can differ from those described here. The sets are illustrated without speakers in most figures.

All the station names, programme contents, the illustrated photos, titles, albums and album covers in this operating manual are examples.

In some countries, the stations also transmit interactive data services with their programmes (see page 49, Digital Teletext/MHEG-5), whereby the functions of individual keys are not available or only so to a limited extent.



The symbol indicates which functions can differ for a loaded application.

The operating instructions for your TV set are updated at irregular intervals. We recommend checking now and then, especially after a software update.

# For your safety

**For your own safety and to prevent unnecessary damage to your device, read and comply with the following safety instructions:**

## Proper use and environmental conditions

This TV set is designed exclusively for reception and reproduction of video and audio signals and is designed for living rooms or office facilities, and should not be operated in rooms with high **humidity**, such as a bathroom, or sauna, or where there is a high **concentration of dust** (e.g. workshops). The manufacturer's warranty is only valid for use in the specified permissible environment.

If the set is used outdoors ensure that it is protected against **moisture** (rain, splashing water, or dew). High humidity and dust concentrations cause leak currents in the device, which can cause a shock hazard if the device is touched, or a fire.

If you have brought the set into a warm environment from the **cold**, then wait for about 1 hour before switching it on to avoid formation of **condensation**.

Do not place any **objects** filled with **liquids** on top of the appliance. Protect the appliance against dripping and splashing water.

**Candles or naked flames** must be kept away from the appliance at all times to prevent it from catching fire.

Never place the TV set in a position where it is exposed to **vibrations**. This can lead to material overload.

## Transporting

Only transport the device in **vertical position**. Grasp the device on the upper and lower edges of the housing. Sets without system speakers should never be placed on the protruding control unit on the bottom of the set. This could damage the control unit.

If the set has to be put down during packing/unpacking, place the TV set with the entire front surface lying flat on a soft underlay such as a blanket or the felt from the packing material.

The LCD screen is made of glass or plastic and can break if not handled properly.

Always wear rubber gloves to carry the TV set if the LCD screen is damaged and **liquid crystal** might be leaking out. In the case of **skin contact** immediately wash thoroughly with water.

## Power supply

The **wrong voltage** can damage the set. This equipment must only be connected to a mains power supply which has the same voltage and frequency as that specified on the rating plate; use the mains cable provided. The **mains plug** of the TV set must be easily accessible so that the device can be disconnected from the mains at any time. When you unplug the mains plug, do not pull on the **cable** rather pull on the plug housing. The cable in the mains plug could be damaged and cause a **short circuit** the next time it is plugged in.

Lay out the **mains cable** in such a manner that it cannot be damaged. The mains cable must not be kinked or laid over sharp edges, stepped on or exposed to **chemicals**; The latter also applies for the entire equipment. A mains cable with damaged insulation can cause **electrical shock** and is a **fire hazard**.

## Air circulation and high temperatures

The **vent slots** on the **rear panel** of the set must always be kept free. Please do not place newspapers or cloths on/over the TV.

Ensure that there is at least 10 cm free space on the sides and above the set for air circulation, if the set is placed in a **cabinet** or on a **shelf**.

Like any electronic device, your TV set requires air for cooling. Obstruction of the air circulation can cause fires.

The set is suitable for different installation solutions. See the instructions for assembly for the different installation solutions.

Stand the TV set with the table or floor stand only on a level, **sturdy, horizontal base**. Particularly ensure that the set does not protrude to the front when placed in or on pieces of furniture. The TV set may only be operated **horizontally**, the vertical tilt must not be more than 10 degrees maximum. The TV set must never be operated on edge, lying on the ground or hanging from the ceiling.

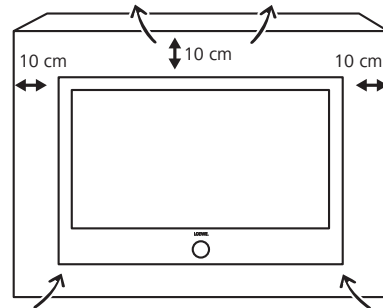
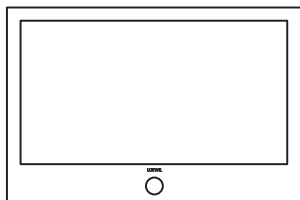



# For your safety

Set up the device where it is not exposed to direct **sunlight** and where it is not exposed to additional warming through **heating elements**.

Prevent **metal items**, needles, paper clips, liquids, wax, or similar items, from getting into the interior of the device through the **vent slots** in the rear panel. Such objects can cause **short circuits** in the set, which could possibly cause a fire.

If something should get into the **interior of the set** then immediately unplug the mains plug of the device and contact **customer service** for more information.

## Repairs and accessories

Never remove the back of the TV set yourself. Only have your TV device repaired or serviced by **authorised television technicians**.

Only use **original accessories** such as Loewe stands if possible (see Accessories on pages 113 and 116).

## Supervision

Do not allow **children** to use the TV set without supervision or to play in the immediate vicinity of the TV set. The set could tip over, be pushed off or pulled down from the stand surface and injure someone.

Do **not** allow the switched-on TV set to run **unattended**.

## Volume

Loud music can lead to ear damage. Avoid extreme volume especially over long periods and when using headphones.

## Thunder storms

Pull out the **mains plug** and all connected **antenna cables** from the TV set in a thunderstorm. Overvoltage caused by **lightning** can damage the set via the antenna system, as well as via the mains. The mains plug and all connected antenna cables should also be pulled out during long periods of **absence**.

## Note on the LCD screen

The TV set you have purchased with LCD screen satisfies the most rigorous quality requirements and has been inspected relative to **pixel errors**. Despite our thorough care when manufacturing the display, it cannot be 100% guaranteed that no **subpixel** defects will be present due to technical reasons. Please understand that these types of effects, as long as they are within the standard of specified limits, cannot be considered as a device defect in terms of the guarantee.

Avoid displaying **still images** for long periods of time. It is possible that a copy of the image may remain.

## Cleaning and care

➡ Switch off the TV set at the main switch before cleaning.

Clean the TV set, the screen, and the remote control unit with a soft, moist, and clean cloth only, **without** any **aggressive** or **scouring cleaning agents**.

Sets with glass screens may be cleaned with a conventional glass cleaner.

# Control unit front side of the device

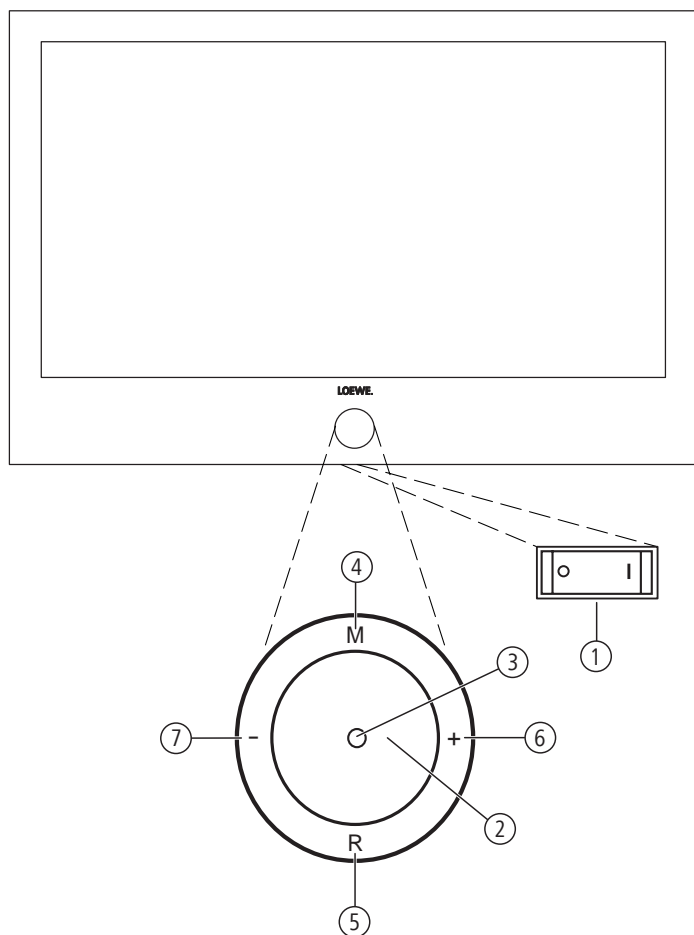

## Functions of the operating elements

- ① **Mains switch:**  
The mains switch is located on the bottom of the set.
- ② **On/Off button:**  
Switch on from the standby mode  
Switch off to the standby mode
- ③ **Display:**
  - red = Standby
  - green = Operation
  - orange = Operation without on-screen display  
(Radio, EPG data capture, timer recording) or archive recording via USB.
- ④ **Button M:**  
Call the menu  
in the menu: up/down ▲ ▼
- ⑤ **Button R:**  
Radio on/off (back to TV mode)  
Switch on the radio from the standby mode  
in the menu: down ▼
- ⑥ **Button +:**  
Station up  
in the menu: to the right ▶
- ⑦ **Button -:**  
Station down  
in the menu: to the left ◀

# Connections rear side of the device

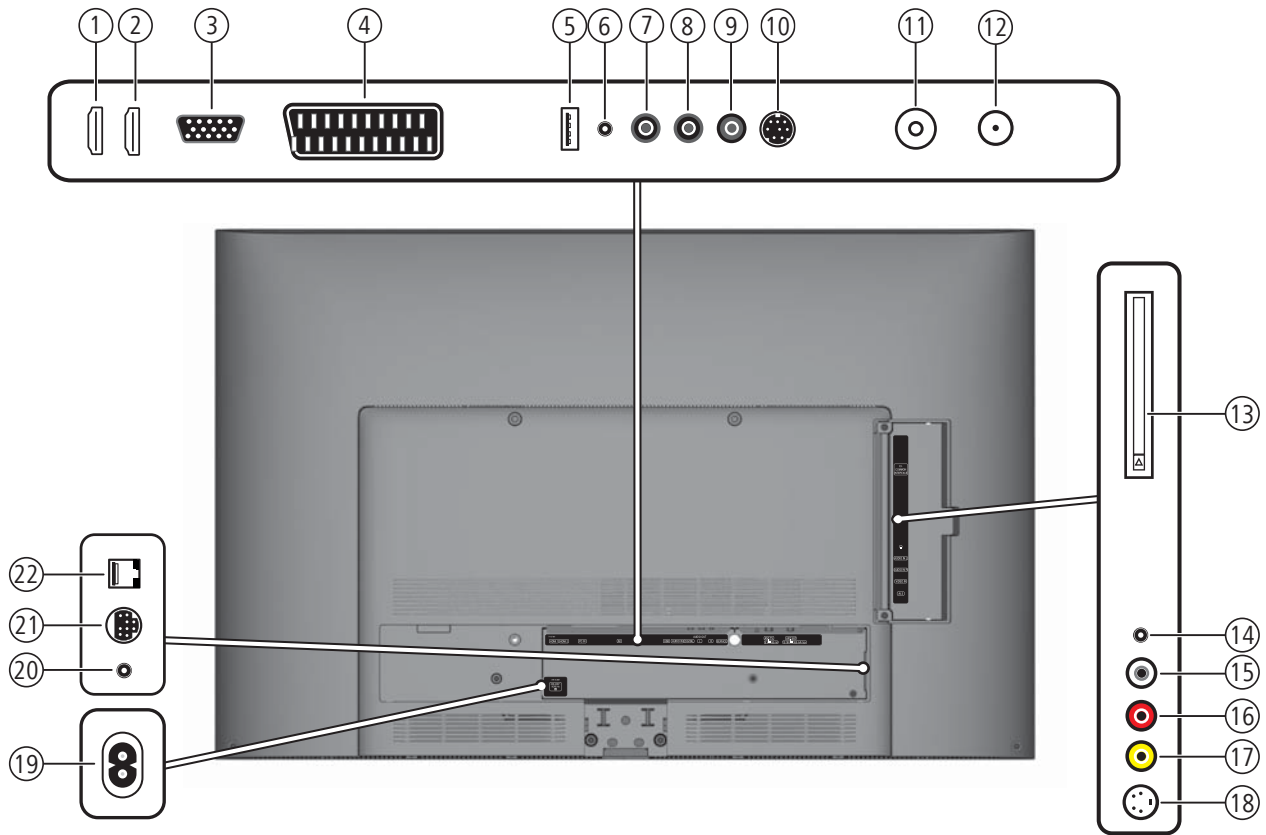

- ① **HDMI 1** - HDMI input 1
- ② **HDMI 2** - HDMI input 2
- ③ **PC IN** - VGA/XGA input
- ④ **AV** - Euro-AV socket
- ⑤ **USB** - USB connection
- ⑥ **AUDIO IN** - Audio input (analogue)
- ⑦ **AUDIO DIGITAL OUT** - Digital audio output
- ⑧ **AUDIO OUT L** - Audio output left (analogue)
- ⑨ **AUDIO OUT R** - Audio output right (analogue)
- ⑩ **SERVICE** - Service socket
- ⑪ **ANT-TV** - Antenna/cable analogue/digital<sup>(1)</sup>

- ⑫ **ANT SAT** - Satellite antenna (Sat tuner)<sup>(1)</sup>
- ⑬ **CI-COMMON INTERFACE** - Common Interface (CI slot)
- ⑭ **Q** - Headphones connection
- ⑮ **AUDIO IN L** - Audio in left (AVS)
- ⑯ **AUDIO IN R** - Audio in right (AVS)
- ⑰ **VIDEO IN** - Video in (AVS)
- ⑱ **AVS** - S-Video connection (AVS)
- ⑲ **220-240V~ 50/60Hz** – Mains connection
- ⑳ **IR LINK** - Infrared transmitter connection<sup>(1)</sup>
- ㉑ **CONTROL** - Rotating stand control<sup>(1)</sup>
- ㉒ **RS-232C** - Serial interface<sup>(1)</sup>

<sup>(1)</sup> Equipment and upgrade options, see page 115.

# Operating convenience

## General information on menu operation

The operation can be divided basically into two areas: The operation of dropdown lists (e.g. station list, favourites list, EPG etc.) and the menu operation (TV menu etc.) for configuring your TV set.

- ➔ If any questions arise during the operation of your TV set, an appropriate info screen can be accessed to help you by pressing the **INFO** button, see also info display on page 15.

### Selection list (example: Station list)



- ▲ ▼ ◀ ▶ You move the cursor by pressing the ring (up, down, left, right).



- P+ / P-** If more selection options are available than will fit on one screen page **page ↓** is displayed. You can scroll the pages with **P+ / P-**.



- OK** The **OK** button calls the selection or confirms the setting.



- With the coloured buttons you can select different options depending on the application. The assignment of the coloured keys is shown at the bottom of the screen.



- INFO:** Additional information about the screen page.



- END:** Close/exit dropdown list.

### Inputs with the numeric buttons



- Letters have to be entered for specific functions. When using the remote control, press the numeric buttons just as on a mobile phone keypad (0-9) until the desired symbol is displayed. The available letters are printed on the individual numeric buttons.



- See page 106 for a detailed overview of the available characters.

### Menu operation (example: TV menu)

Menus for the individual modes (TV, Radio, PIP, EPG, Teletext, MediaPortal and DR archive/Video archive<sup>(1)</sup>) are called with the **MENU** button.

The menus are displayed at the bottom of the screen. At the top you get additional information about the selected menu item (see info display on page 15).

- ➔ In normal TV mode, without other displays.

**MENU:** Call TV menu.

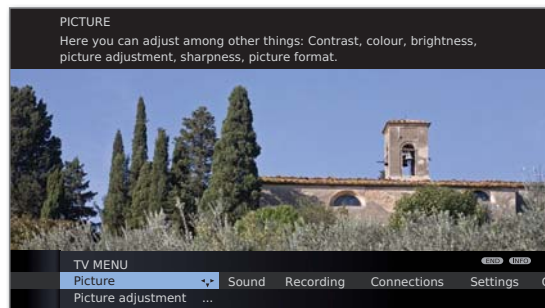

- ◀ ▶ Select **Picture**,
  - ▼ go to the menu line below.
- ◀ ▶ Select **Brightness**,
  - ▼ go to the menu line below.
- ◀ ▶ Set **Brightness**.
  - ▲ Return to the **Brightness** menu line to make other picture settings.
- ◀ ▶ Select **more ...**,
  - OK** call **more ...** functions.
- ◀ ▶ Select **Auto format**,
  - ▼ go to the menu line below.
- ◀ ▶ Select **on / off**.

**END:** Conclude the settings.



### Menu structure

You can find a diagram of the menu structure in the overview diagrams, page 16 and after.

<sup>(1)</sup> Only if an external hard disc is connected (USB Recording).

# Operating convenience

## Operating convenience with wizards

For many settings your TV set has user guidance with wizards which guide you through the settings step by step.

## Overview of wizards

### Initial installation

The initial installation wizard helps you with the initial installation and connection of any existing equipment (see page 21).

### Setting up the antenna

You enter in the antenna wizard which antenna signals are available to you. The antenna wizard is called in initial installation (see page 21). You can also call the antenna wizard in the **TV menu** under **Connections** → **Antenna DVB** → **Antenna DVB-S**<sup>(1)</sup> or **Antenna DVB-T**.

### Search wizard

If you want to search for new stations after the initial installation, or if you have set up your antenna for the first time, then you can handle this task with the help of the search wizard (see page 39). You will find the search wizard in the **TV menu** under **Settings** → **Stations** → **Search wizard**.

### Connecting sound components

The sound component wizard ensures that the components which reproduce the TV sound are correctly registered, connected and set. It is started automatically at the end of the initial installation wizard but can also be called separately (see page 96). You will find the sound components wizard in the **TV menu** under **Connections** → **Sound components**.

### Programming and managing recordings

The recording wizard helps you to program a recording with a video recorder, DVD recorder or via USB recording onto an external hard disc connected via USB (see from page 99 onwards).

### Software update

You can download the latest software for your TV set from the Loewe Service site and update using a USB stick (see page 103).

<sup>(1)</sup> Equipment and upgrade options, see page 115.

# Operating convenience

## MediaPortal

The MediaPortal is the central overview page for your TV set's functions. From here you can gain access to TV channels, local media, digital radio and to the archive of the Digital Recorder.

### Call MediaPortal

MEDIA

**MEDIA:** Call **MediaPortal**.

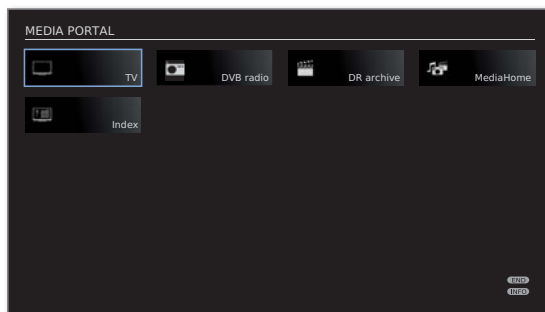

The individual media and the various functions are displayed at the top of the MediaPortal.



◀ ▶ ▲ ▼ Select menu item,  
**OK** call.

### Description of the individual functions:

- TV:** Here you call the TV mode of your TV set. See page 29 for further information.
- DVB radio:** Use this to open the DVB radio mode of your TV set to listen to digital radio stations over DVB. See page 49 for further information.
- DR archive:** With the **DR archive** you have access to all the recorded programmes contained on any USB storage devices that are connected. The menu item only appears if an external hard disc has been connected to the USB interface. See page 65 for further information.
- MediaHome:** Here you have access to your personal storage devices connected to the USB interface. See page 56 onwards for further information.
- Index:** Here you have access to the index integrated in the TV set. See page 15 for further information.

<sup>1)</sup> Depending upon which equipment the TV set has.

# Operating convenience

## The index in the TV set

The index explains the TV functions and the terms that you may be confronted with when operating the TV set. You can start all the assistants and many of the operating functions directly from here.

Alphabetic sorting is preceded by the items **Menu language**, **Energy efficiency**, **Integrated features** and **Repeat initial installation**.

### Call index

MEDIA

**MEDIA:** Call **MediaPortal**.



◀ ▶ ▲ ▼ Select **Index**,  
**OK** call.

You will see an info text for the highlighted keyword in the info display.

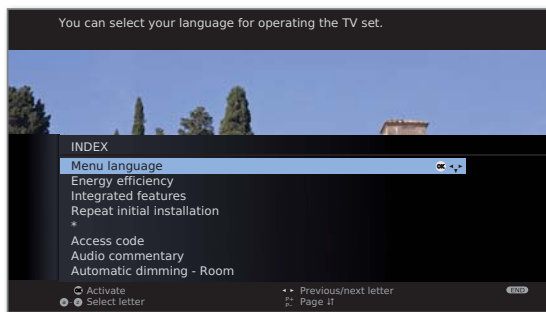

If an OK symbol appears in the marked line, this function can be called directly with **OK**.

### Selecting a keyword



Enter initial letters with the **numeric buttons** like with a mobile phone keypad (see page 12).

or go with:



◀ ▶ to the preceding / next letters,  
▼ ▲ from line to line,



**P+ / P-** scroll backwards or forwards in whole pages.

Example: You want to have the TV set switch off automatically at a specific time:

Select the keyword **Switch off** → **Automatic**, with **OK** you can activate the setting and with ◀ back again.

## The info display

The info display provides an info text appropriate to the on-screen display that can assist you further with the operation of your TV set. Together with the index it makes for a comfortable operating system.

➡ An on-screen display is faded in.

INFO

The factory setting is that the info display is shown automatically for each menu item. In this case you can temporarily hide the info texts with the **INFO button**.

The automatic info display can be hidden via a menu setting. Then it can be displayed temporarily by pressing the **INFO button**.

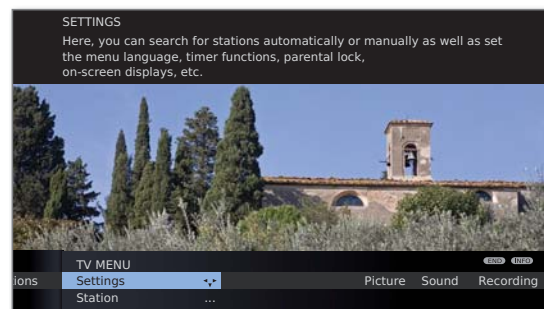

An **INFO** icon at the bottom right above the menu bar also tells you that an info text is available.



If an info text over several pages is available the number of available pages and **P+P- Page 1/1** is displayed in the Info window. You can scroll through the individual info pages with **P+** and **P-**.

### Permanently display or hide the automatic info display

Once you have become familiar with how to operate the TV set, you can switch off the automatic info display.

➡ In normal TV mode, without other displays.

MENU



**MENU:** Call **TV menu**.

◀ ▶ Select **Settings**,  
▼ go to the menu line below.

◀ ▶ Select **Miscellaneous**,  
▼ go to the menu line below.

◀ ▶ Select **On-screen displays**,  
▼ go to the menu line below.

◀ ▶ Select **Automatic info**,  
▼ go to the menu line below: **yes / no**.

# Operating convenience

## TV menu – Overview diagram

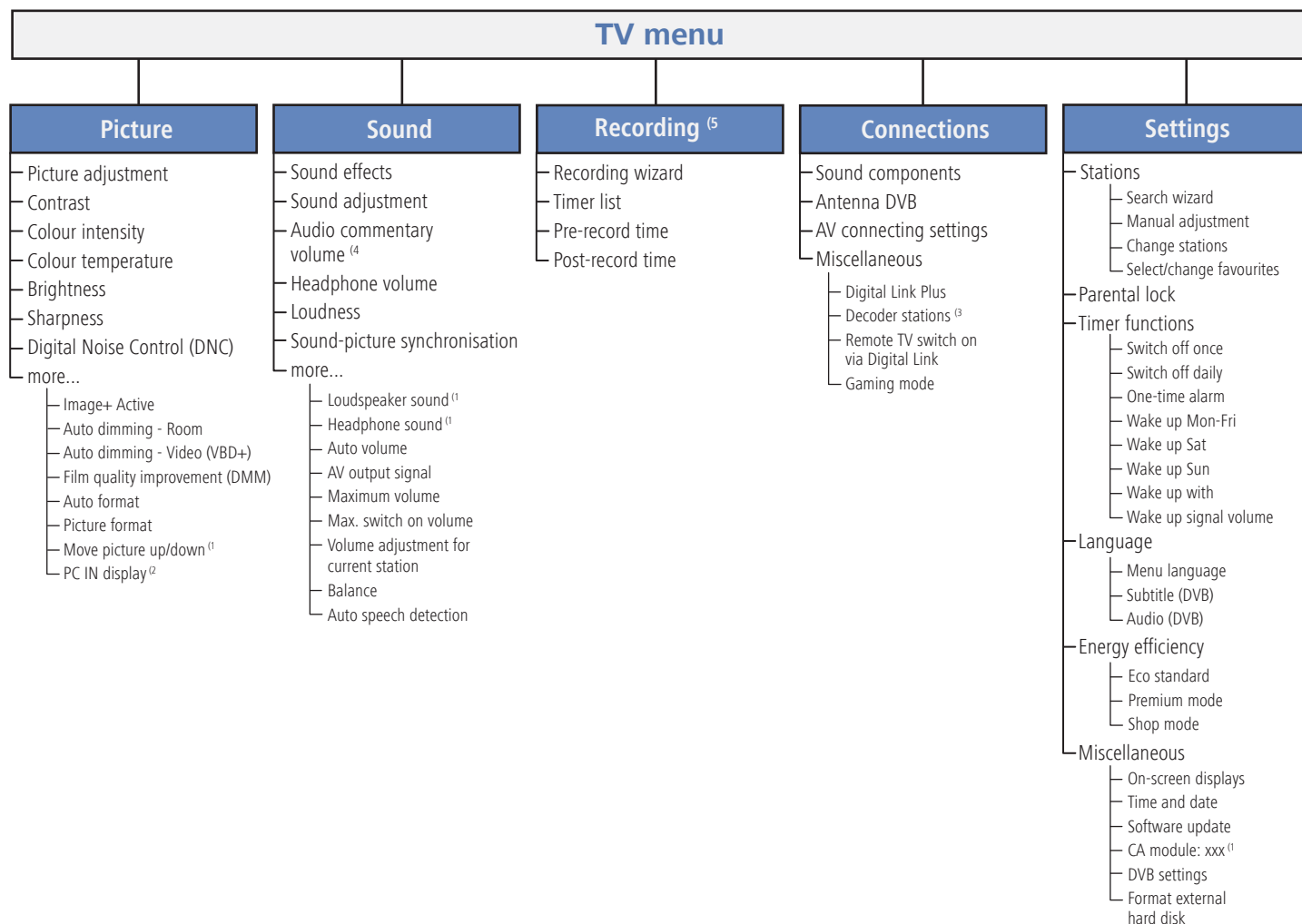

<sup>1</sup> Menu items appear depending on the signal source currently selected (DVB or analogue) and/or at definite presets in the relevant menus. For individual details, see the corresponding chapter of the operating instructions.

<sup>2</sup> Menu item can only be selected if a valid signal is present at the PC IN input.

<sup>3</sup> Menu item only available if a Decoder has been selected as Device at connection AV (see page 89).

<sup>4</sup> Menu item only appears if the audio commentary is activated and available (see page 38).

<sup>5</sup> Menu item only appears if an external hard disc is connected or if a recorder has been selected as an AV device (see page 89).



# Operating convenience

## Radio menu – Overview diagram

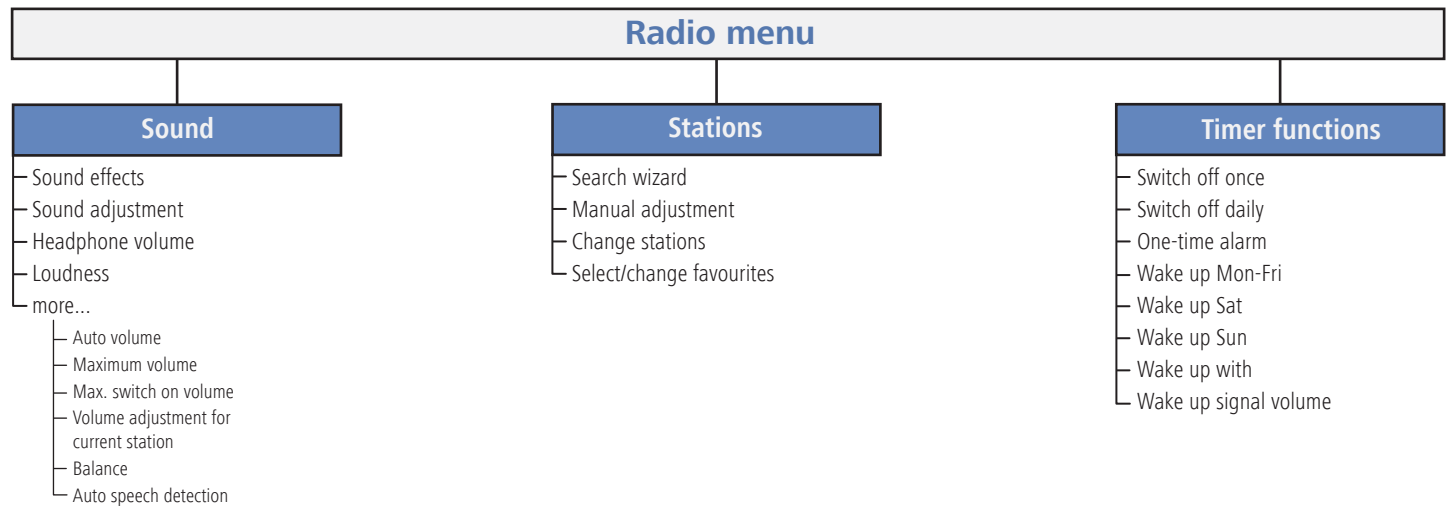

## Other menus – Overview diagram

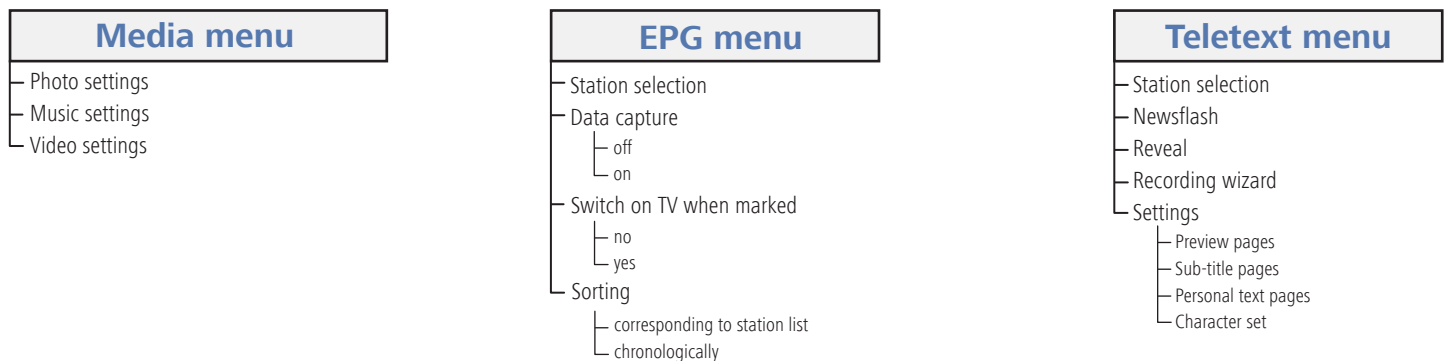

# Initial installation

## Installing the TV set

### Installation options

Your TV set is supplied equipped with a table stand. You are given the option of choosing another installation solution tailored to your requirements from your Loewe dealer. Only use Loewe installation solutions (e.g. wall mounts, floor stand) that are included in the Accessories – Setup possibilities chapter on page 116.

After selecting an installation option, read the appropriate assembly instructions.

### Installation notes

Choose a place for installing your TV where no bright light or sunlight shines directly onto the screen. This could cause reflections which impair the picture.

3 times the screen diagonal can be taken as a guide value or the viewing distance (e.g. for 40-inch set approx. 3m for SD signal). The viewing distance can be reduced with an HD signal.

## Set covers

### Covers for rear and side connections

To remove the rear cable cover, pull the centre of the projection at the lower end of the cover and fold it away from the set.

To fit the cover, insert the lugs at the top edge of the cover into the corresponding cut-outs in the rear panel and push up the cover until it snaps in.

The side cover of the TV set can also be completely removed. For this, open it as far as it will go and gently pull on the open cover.

The cover detaches from the holder and gives free access to the connection area. To replace the cover, simply push it until it latches back into place.

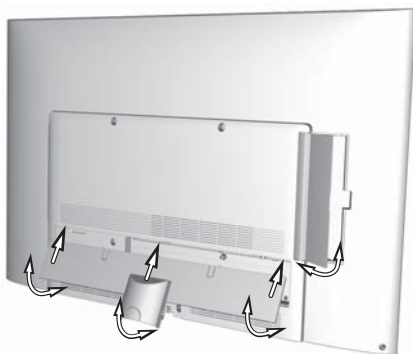

## Connecting the TV Set

### Connecting to the mains

Remove the cover for the connections.

Connect the TV set to a 220-240V mains socket:

First plug the small plug of the power cable into the mains connection on the back of the TV and then the large mains plug into a mains socket.

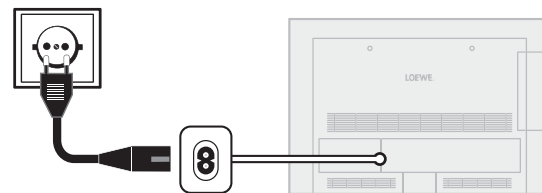

### Connecting antennas

Cable (analogue) / DVB-C / DVB-T antenna:

Plug the antenna cable of antenna, cable system or room antenna into the **ANT TV** socket.

If you want to use analogue cables / DVB-C connection and a DVB-T antenna together, use an external antenna switch (available from your dealer).

Satellite antenna DVB-S:

If the TV set is equipped with a satellite tuner (retrofit kit), the **ANT-SAT** socket is available.

Depending on the used satellite system, connect a connecting cable from the multi-switch or directly from the LNC to the **ANT-SAT** socket of the TV.

When connecting the TV set to a single cable community antenna, connect the **ANT-SAT** socket directly to the appropriate SAT antenna socket.

Ask your dealer if required.

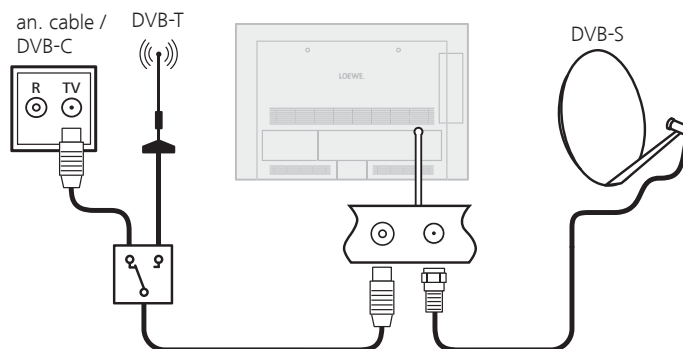

# Initial installation

## Bundling the cables

The cables connected to the TV set can be bundled and fixed to the back of the housing using the Velcro cable tie provided.

Then fit the cover for the connections (see page 18).

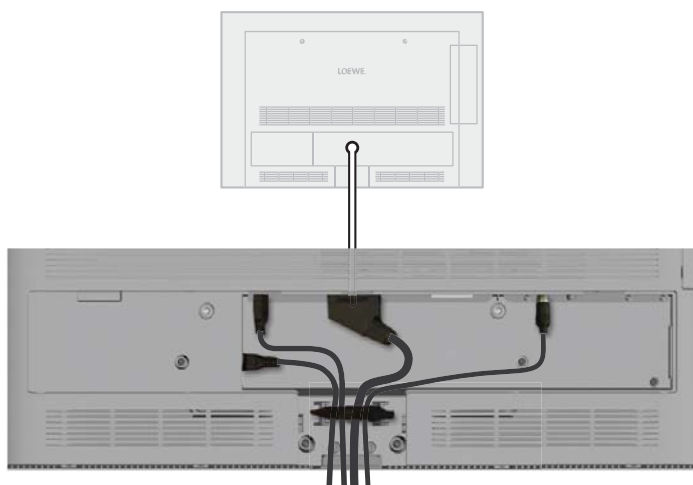

## Preparing the remote control unit

### Inserting or replacing batteries

Press on the embossed arrow whilst pushing the battery cover down.

Only use leak-proof micro-cells of the LR 03 (AAA) Alkali-Manganese type. Do not use different types of batteries and old and new batteries together.

Pay attention to the correct polarity of + and – when inserting the batteries.

If the batteries are too weak after longer use, the TV set prompts you to change the batteries.

Dispose of used batteries in an environmentally friendly way (see page 117).

Push the cover back on from below after inserting the batteries.



### Adjusting the remote control for operating the TV set

TV

Press the **TV button**.

See page 102 for how to operate other Loewe appliances and how to reprogramme the remote control buttons.

# Initial installation

## Turning the set on/off

### Switching the TV set to standby mode

Press the mains switch on the bottom right of the set.

The display in the control panel on the front lights up first orange and then red. The set is now in standby mode.

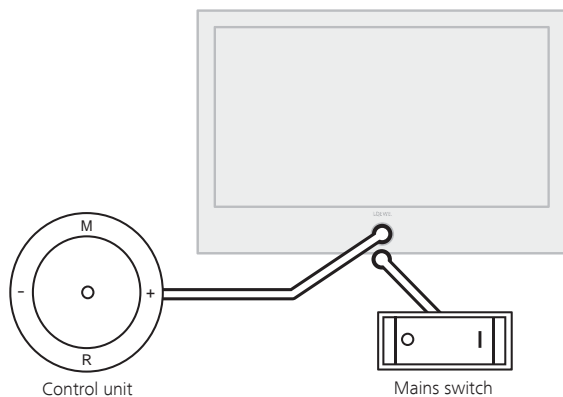

### Switching the TV on/off on the control unit

To switch the TV set into Operating mode or switch it off into Standby mode, press the middle of the On/Off button for about 2 seconds.

Meaning of the display colour of the LEDs in the On/Off button:

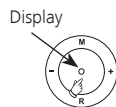

**Red:** Standby mode

**Green:** TV set is switched on

**Orange:** Radio mode, the device receives EPG data, timer recording is active or archive recording via USB is active.

### Switching the set on with the remote control



Press the **on/off button**



or  
**numeric buttons**



or  
**TV button**



or  
**OK button** – station list is called



or  
**MEDIA button** – **MediaPortal** is called.

### Switching the set off with the remote control



Press the **on/off button**.

➡ Before switching off the set with the mains switch, we recommend you to switch it to standby mode.

### Switch on in Radio mode



Press **R** on the TV control unit.



OR:  
Press the **AUDIO button** on the remote control (radio mode, see page 49).

# Initial installation

## First installation wizard

### Initial installation after switching on for the first time

This wizard starts automatically after the set is switched on for the first time, however it can also be called later manually in the TV index, see **Repeat initial installation** on page 15.

- ➡ If at least one station is locked the access code must be entered before repeating initial installation (see Parental lock on page 52).

### First installation wizard routine

The routine of the first installation wizard depend on the selected settings.

#### Language

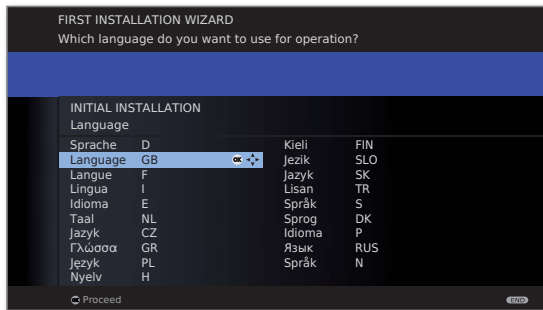

▲ ▼ ◀ ▶ Select language.

Selecting the language of the user guidance is the wizard's first step. Then you simply follow the instructions on your TV screen.

**OK Proceed.**

#### Energy efficiency

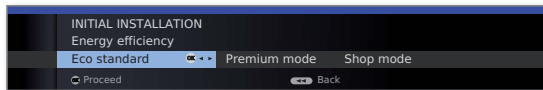

◀ ▶ Select Energy efficiency.

Decide how energy efficiently you want to operate your TV set. The value for the contrast (and thus the brightness of the background lighting) is adapted and the automatic dimmer activated or deactivated (see page 33) depending on the presetting.

Energy efficiency (continued)

#### Eco standard:

The emphasis for home use is on low energy consumption. The automatic dimmer is activated.

#### Premium mode:

This mode optimises the settings to a brighter environment at a higher energy consumption. The automatic dimmer is activated.

#### Shop mode:

The picture settings are aligned to operation in the presentation room. The automatic dimmer is deactivated. If the ambient brightness diminishes, the energy consumption is not reduced.

The presetting can be changed later in the **TV menu** under **Picture** → **Picture adjustment** → **Presettings** (see page 33) or under **Settings** → **Energy efficiency**.

**OK proceed.**



Location of TV set

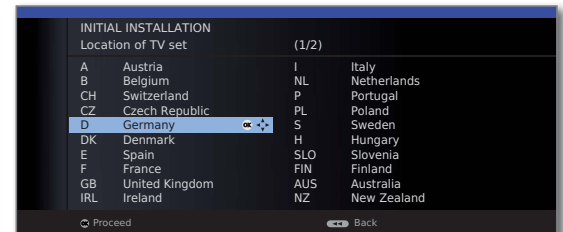

▲ ▼ ◀ ▶ Select Location of TV set (national defaults are adopted).

**OK Proceed.**

Selecting antennas

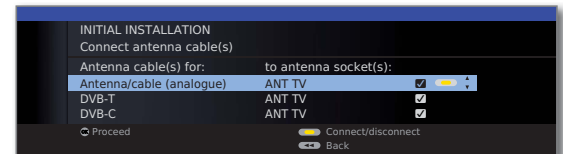

▲ ▼ Select antenna cable.



**Yellow button: Connect/disconnect antenna cable.**

**Antenna/cable (analogue):** analogue stations via cable/antenna  
**DVB-T:** digital terrestrial stations  
**DVB-C:** digital stations via cable  
**DVB-S:** digital stations via satellite

continued on next page →

# Initial installation

Selecting antennas (continued)

The selection options for the aerials depend on the receiver units installed or upgraded at the factory (see also page 115).

Depending on which antenna(s) was (were) selected, the appropriate settings are called later during the routine.



**OK proceed.**

Subtitle and audio languages (DVB)

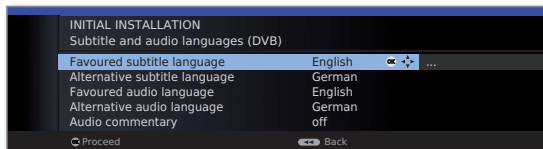

▲ ▼ ◀ ▶ Select desired languages and alternative languages for subtitles and audio for DVB programmes (see page 53).

Set up audio commentary for the visually impaired (see page 38).

**OK Proceed.**

Logical Channel Number

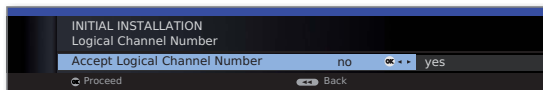

◀ ▶ Accept Logical Channel Number **no / yes.**

In various countries, digital stations (DVB-T, DVB-C, DVB-S) are transmitted with a preset channel number per station, known as "Logical Channel Numbers" – "LCN".

If you indicate **yes** here, the specified programme numbers will be adopted as station memory locations and the stations of the preferred signal sources sorted by LCN. There may be gaps in the numbering of the station list depending on the LCN.

**OK Proceed.**

Depending on which antennas (DVB-T, DVB-C, DVB-S) were selected, the appropriate settings appear below.

## Setting options for DVB-T reception:

If you have not selected a DVB-T antenna in the antenna selection: Continue with **setting options for DVB-C reception** on page 23.

Settings

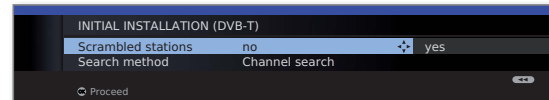

▲ ▼ ◀ ▶ Select and adapt settings for DVB-T reception.

Encrypted stations

You can state whether coded stations are to be searched for in the search/update. Select **yes** to save all found scrambled stations. However, these stations can only be received in connection with a CA module and the appropriate Smart Card. Handling of the CA module is described on page 55.

If a CA module with a SmartCard is already plugged in for the station search, all the stations which this module can descramble are also saved when **no** is preset.

Search method

If you want to run the station search independently of the channel grid, select **frequency search** for the search method.

**OK Proceed.**

Supply voltage

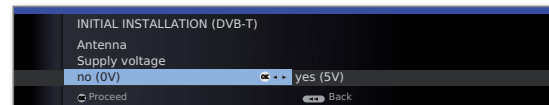

◀ ▶ Select supply voltage **no / yes.**

Use a DVB-T antenna that requires a supply voltage (active antenna) and which is not already supplied via a power adapter, then select **yes (5V)** for the antenna's power supply.

How to align your DVB-T antenna is described on page 28.

**OK Proceed.**

# Initial installation

## Setting options for DVB-C reception:

If you have not selected a DVB-C antenna in the antenna selection: Continue with **Setting options for DVB-S reception** (see right hand column).

The normal DVB-C settings are derived from the selection of the location and do not need to be changed.

Settings

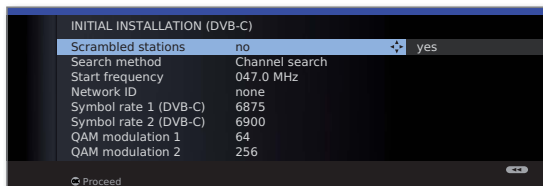

▲ ▼ ◀ ▶ Select and adapt settings for DVB-C reception.

Encrypted stations

You can state whether coded stations are to be searched for in the search/update. Select **yes** to save all found scrambled stations. However, these stations can only be received in connection with a CA module and the appropriate Smart Card. Handling of the CA module is described on page 55.

If a CA module with a SmartCard is already plugged in for the station search, all the stations which this module can descramble are also saved when **no** is preset.

Search method

If you want to run the station search independently of the channel grid, select **frequency search** for the search method.

Start frequency

The DVB stations are only searched for in the frequency range above the start frequency.

Network ID

Only change these defaults if you are familiar with other symbol rates and types of modulation or if you have to specify the network ID for your cable network. In the case of small cable networks fed directly from the satellite, the rate of 6900 might have to be replaced by 6111.

Symbol rate

Your cable provider has the information you need.

QAM modulation

Your cable provider has the information you need.



**OK Proceed.**

## Setting options for DVB-S reception:

If you have not selected a DVB-S antenna in the antenna selection: Continue with **Setting options for all types of reception** on page 27.

The normal DVB-S settings are derived from the selection of the location and do not need to be changed in most cases.

Select satellite installation

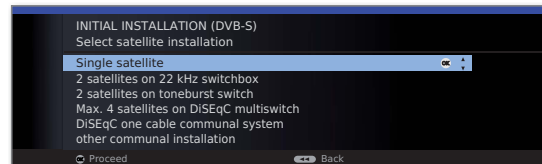

▲ ▼ Selecting the satellite system.

Specify how you receive which satellite(s) (single satellite or type of satellite system). Ask your dealer if required.

Single satellite

Reception of a single satellite via a connected LNC (LNB). See page 24 for settings.

2 satellites on 22 kHz switchbox

Reception of two different satellites with two LNCs (LNBS) which are connected to the TV set by a 22 kHz switchbox. See page 24 for settings.

2 satellites on toneburst switch

Reception of two different satellites with two LNCs (LNBS) which are connected to the TV set by a toneburst switch. See page 24 for settings.

Max. 4 satellites on DiSEqC multiswitch

The TV set controls a DiSEqC multiswitch to which up to four LNCs (LNBS) for different satellites are connected. See page 25 for settings.

DiSEqC one cable communal system

Select setting if the TV set is connected to a DiSEqC single-cable system (according to EN 50494). Several Sat receivers can be connected to one Sat cable. See page 25 for settings.

other communal installation

Select setting if the TV set is connected to a single-cable system (without DiSEqC). Several Sat receivers can be connected to one Sat cable. Unlike a DiSEqC single-cable system there are restrictions in the range of certain reception frequencies in single-cable community systems. See page 26 for settings.



**OK Proceed**

(to the appropriate page of the satellite system).

# Initial installation

## Setting options for the satellite system (single satellite):

Select single satellite



▲ ▼ Select satellite,  
**OK Proceed.**

High band

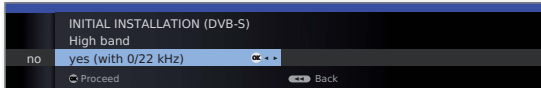

◀ ▶ High band **no / yes.**  
Specify here whether the high band of the selected satellite is to be searched in addition to the low band.

**OK Proceed.**

LNB frequencies

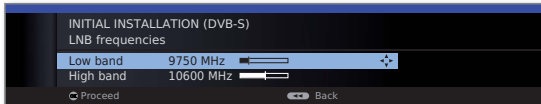

◀ ▶ Set LNB frequencies.  
Normally, you do not need to change the values for high and low band, unless the LNC (LNB) of your satellite system uses a different oscillator frequency (important for the frequency display).

**OK Proceed.**  
(with **Setting options for DVB-S reception (continued)** on page 26).

## Setting options for the satellite system (2 satellites on 22 kHz switchbox / 2 satellites on toneburst switch):

Satellite selection

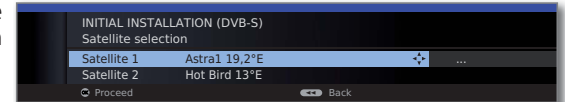

▲ ▼ Select **Satellite 1 / Satellite 2,**  
▶ select satellites from list,  
**OK Proceed.**

LNB frequencies  
(22 kHz switchbox)

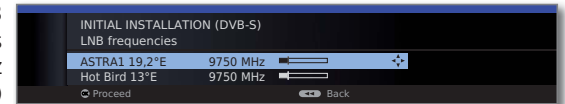

LNB frequencies  
(toneburst switch)



◀ ▶ Set LNB frequencies.  
Normally, you do not need to change the values for high and low band, unless the LNC (LNB) of your satellite system uses a different oscillator frequency (important for the frequency display).

**OK Proceed.**  
(with **Setting options for DVB-S reception (continued)** on page 26).



# Initial installation

## Setting options for the satellite system (max. 4 satellites on DiSEqC multiswitch):

Settings  
DiSEqC  
multiswitch

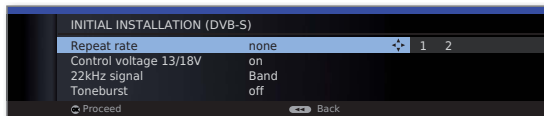

▲ ▼ ◀ ▶ Select and adapt settings for the DiSEqC multiswitch.

**Repeat rate** The refresh rate determines how often a DiSEqC command is output. A refresh is only necessary with cascaded systems.

**Control voltage** The control voltage controls the switching of the polarisation level (horizontal/vertical) in non-DiSEqC capable components (e.g. control of single LNBs via DiSEqC multiswitch).

**22kHz signal** The 22kHz signal controls the switching between high and low band in the **Band** setting. The **Position** setting controls the selection of the satellites in non-DiSEqC capable components.

**Toneburst** The Toneburst controls the selection of the satellites in non-DiSEqC but toneburst capable components with the **Position** and **Option** settings.

**OK Proceed**

Satellite  
selection

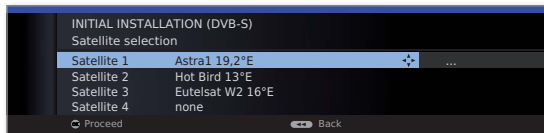

▲ ▼ Select **Satellite 1 ... Satellite 4**,  
▶ select satellites from list,  
**OK Proceed.**

LNB  
frequencies



◀ ▶ Set LNB frequencies.  
You do not normally need to change the values.  
**OK Proceed.**  
(with **Setting options for DVB-S reception (continued)**  
on page 26).

## Setting options for the satellite system (DiSEqC one cable communal system):

DiSEqC one  
cable  
communal  
system

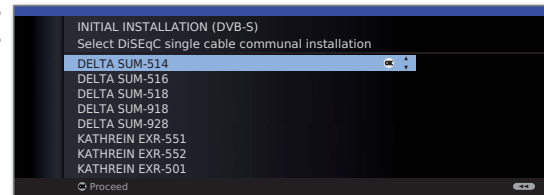

▲ ▼ Select DiSEqC single cable communal installation.  
**OK Proceed.**

Satellite  
selection

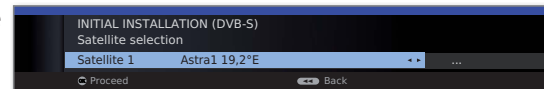

▶ Select satellites from list,  
**OK Proceed.**

LNB  
frequencies

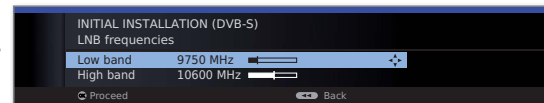

◀ ▶ Set LNB frequencies.  
Normally, you do not need to change the values for high and low band, unless the LNC (LNB) of your satellite system uses a different oscillator frequency (important for the frequency display).

**OK Proceed.**

Manual  
registration  
(for socket  
ANT SAT)

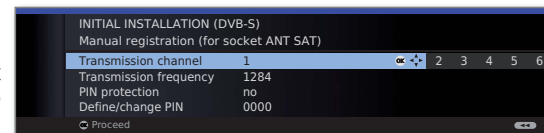

▲ ▼ ◀ ▶ Select and adjust settings for the DiSEqC single cable communal installation.

**Transmission channel/frequency** Select the desired transmission channel and the corresponding transmission frequency.

**PIN protection** If your system is designed for it, it is possible to protect your used transmission data from use by other subscribers with a PIN.



**OK Proceed.**  
(with **Setting options for DVB-S reception (continued)**  
on page 26).

# Initial installation

## Setting options for the satellite system (other communal installation):

Select single  
satellite



▲ ▼ Select satellite,  
**OK Proceed.**

LNB  
settings

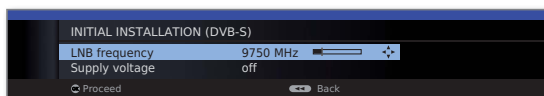

▲ ▼ ◀ ▶ Select and adapt settings.

LNC  
frequency

Normally, you do not need to change the values for high and low band, unless the LNC (LNB) of your satellite system uses a different oscillator frequency (important for the frequency display).

Supply voltage

If your set is connected to a single-cable system without external voltage supply, you can connect the antenna supply (13V or 18V / max. 450mA).



**OK Proceed.**

(with **Setting options for all types of reception** on page 27).

## Setting options for DVB-S reception (continued):

Test reception

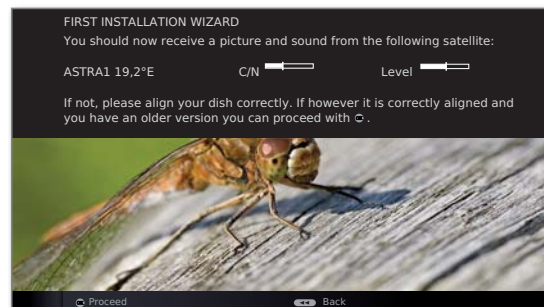

After you have made the previous settings, you should receive picture and sound of the selected satellites (only possible for Astra1 and HOTBIRD).

**OK Proceed.**



Settings

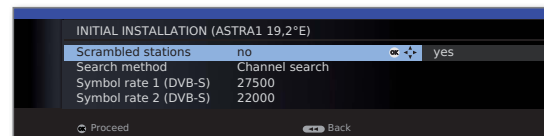

▲ ▼ ◀ ▶ Select and adapt settings.

If several satellites are received, the following settings must be made for every satellite. The scope of the settings may differ depending on the selected satellite.

Encrypted  
stations

You can state whether coded stations are to be searched for in the search/update. Select **yes** to save all found scrambled stations. However, these stations can only be received in connection with a CA module and the appropriate Smart Card. Handling of the CA module is described on page 55.

If a CA module with a SmartCard is already plugged in for the station search, all the stations which this module can descramble are also saved when **no** is preset.

Search  
method

If you want to run the station search independently of the channel grid, select **frequency search** for the search method.

Symbol rates

The symbol rates are specified by the satellite provider and do not normally need to be changed.



**OK Proceed.**

# Initial installation

## Setting options for all types of reception:

Favoured signal source

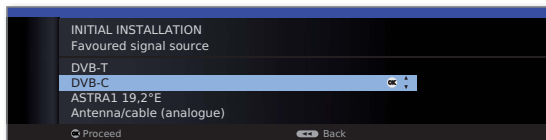

▲ ▼ Select favoured signal source.

Select the signal source from a list, the station of which is to be at the top of your station list (starting with station slot 1).

The listed signal sources depend on the selected antennas and, if the set is equipped with a satellite tuner, the type of satellite system used and the received satellites.

**OK Proceed.**

Overview of settings for station search

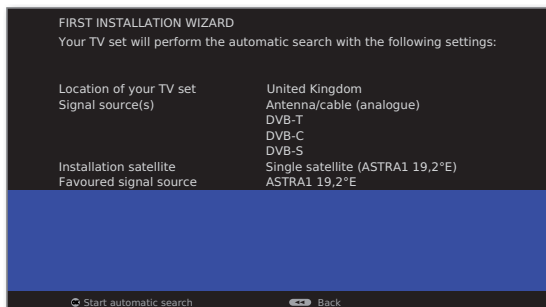

You will see a list of the selected settings. You can go back in steps with the ◀ button to make any changes to the settings.



**OK Start automatic search.**

The set now searches for TV and radio stations. The stations found in the automatic search are divided into the appropriate station blocks depending on the previously selected antenna cables (signal sources). Subsequently the stations can only be re-sorted within these blocks.

➡ At the beginning of the station list you will find the block with the stations of the preferred signal source. Any mixed sorting of stations from different signal sources is only possible with the favourites list.

Info  
TV stations

### FIRST INSTALLATION WIZARD

The automatic TV station search and sorting has ended. 966 new TV station(s) has (have) been found.



The number of found TV stations is displayed.

**OK Proceed.**

Structure TV station list

### FIRST INSTALLATION WIZARD: STRUCTURE OF TV STATION LIST

The TV stations found in the automatic search were divided into appropriate station blocks according to the previously selected antenna cables (signal sources). The stations can only be reorganised later within these blocks. The block with the stations of your favoured signal source is at the top of the station list.

Signal source	Associated station numbers
ASTRA1 19,2°E	1- 900
DVB-C	901-1300
DVB-T	1301-1400
Antenna/cable (analogue)	1401-1500



The structure of the TV station list is displayed.

**OK Proceed.**

Info  
radio stations

### FIRST INSTALLATION WIZARD

The automatic radio station search and sorting has ended. 336 new radio station(s) has (have) been found.



The number of found radio stations is displayed.

**OK Proceed.**

Structure radio station list

### FIRST INSTALLATION WIZARD: STRUCTURE OF RADIO STATION LIST

The radio stations found in the automatic search were divided into appropriate station blocks according to the previously selected antenna cables (signal sources). The stations can only be reorganised later within these blocks. The block with the stations of your favoured signal source is at the top of the station list.

Signal source(s)	Associated station numbers
ASTRA1 19,2°E	1- 300
DVB-C	301-500
DVB-T	501-700
Antenna/cable (analogue)	701-900



The structure of the radio station list is displayed.

**OK Proceed.**

Age-related lock

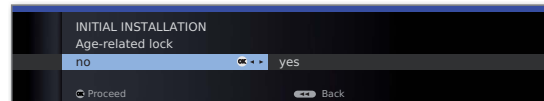

◀ ▶ Select **Age-related lock.**

You can specify an age limit for your TV set here. DVB broadcasts which have an appropriate age identification are locked and can only be watched after entering the access code (see page 52).

**OK Proceed.**

continued on next page →

# Initial installation

Time and date

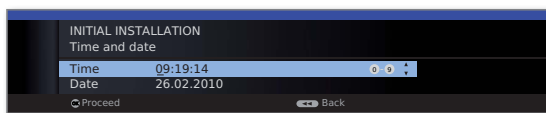

- ▲ ▼ Select time / date.

If no values or no correct values have been entered for the data and time, enter the correct values with the numeric buttons here.

**OK Proceed.**

Sound playback  
via ...

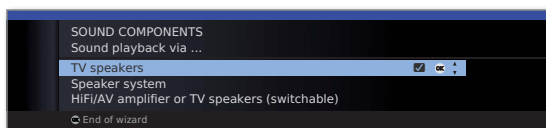

- ▲ ▼ Select sound components.

This selection indicates which sound components you want to use to hear your TV sound. Depending on the selection, the sound component wizard starts with which you can make further settings.

The sound component wizard is described on page 96 and can also be started at any time outside of first time operation (**TV menu** under **Connections** → **Sound components**).

**OK End of wizard.**

## Positioning/aligning DVB-T antenna

If you are receiving one or more DVB-T stations with picture and sound interference then you should change the installation location and alignment of the antenna. Ask your dealer to tell you which channels are used to broadcast the DVB-T stations in your region.

- ➡ In normal TV mode, without other displays. A DVB-T station is received and selected.



**MENU:** Call **TV menu**.



- ◀ ▶ Select **Settings**,
  - ▼ go to the menu line below.
- ◀ ▶ Select **Stations**,
  - ▼ go to the menu line below.
- ◀ ▶ Select **Manual adjustment**,
  - OK** call manual adjustment.



The signal source is already on DVB-T due to the station preselection.

Position and align the antenna in such a manner that maximum values for **C/N** and **Level** are obtained.



**Blue button:** Start search.

Search for DVB-T stations one after another and compare values for **C/N** and **Level**.

Then position/align the antenna to the weakest station so that maximum values for **C/N** and **Level** are obtained. The value for **BER** should be as low as possible.

Thereafter perform an automatic search for all DVB-T stations (see page 39).

# Daily operation

## Select station

### Select station with P+ / P-

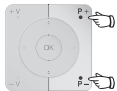

**P+/P-** Station up/down.

The status display with station title, progress bar, time and sound identification signal is shown briefly (see page 37).

- ➔ If Favourites are selected, you can change to the corresponding station in the Favorites list using **P+/P-** (see page 30).
- ➔ The symbols for the sound identification are described on page 37.
- ➔ If there are additional languages or DVB subtitles for DVB stations, then language and subtitle selection is shown below the station display. See also page 38: Selection possibilities for DVB stations.

### Select station using the numeric buttons



#### 1-digit stations

Keep the **numeric button** pressed for one second, the station changes immediately.

or:

Press the **numeric button** briefly, the station changes after 2 seconds (changes immediately in case up to 9 stations are stored).



#### 2-digit and 3-digit stations

Press first (and second) **numeric button** briefly.

Keep the last **numeric button** pressed for one second, the station changes immediately.

or:

Press all the **numeric buttons** briefly, the station changes after 2 seconds (changes immediately in case of up to 99 or 999 stored stations).

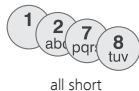

#### 4-digit stations

Press all four **numeric buttons**, the station changes immediately.

- ➔ If Favorites are selected, you can change to the corresponding station in the Favorites list using the numeric keys (see page 30). Maximum two-digit station numbers are possible.
- ➔ If you select an unoccupied station slot, the next available station is switched to.

### Select station with the station list



- ➔ In normal TV operation, without further displays, no favourites selected:

#### OK Call Station list.



Sorting numerically



**P+/P-** Scroll in the pages of the station list.



◀▶ Jump to the next station block.



▲▼◀▶ Mark stations.



or:

Input the channel number.

The marked station is shown as a small picture.



**OK** The marked station is called.



**Blue button:** Changes the sorting between **numerically** and **alphabetically**.

Sorting alphabetically

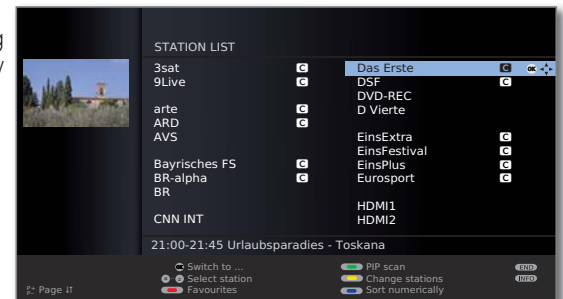

Input the first letter (see also page 12).

The first station for the specified letters is marked.



▲▼◀▶ Mark stations.

**OK** The marked station is called..

# Daily operation

## Select station via favourites list

You can save and call your favourite stations in 6 favourites lists (e.g. for multiple users). Each favourites list can contain up to 99 stations. After initial installation, 10 stations from the station list are already stored in the first list. Change the favourites list to suit your requirements (see **Put together / change favourites lists** on page 42).

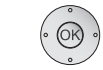

➡ In normal TV mode, without other displays:

**OK** calls the station list.



**Red button:** Calls the favourites list.

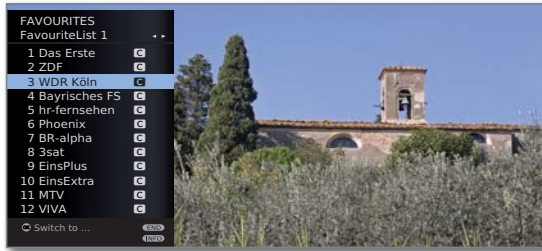

**P+/P-** Scroll in the pages of the favourites list.



Select station directly with **numeric buttons**. Or:

▲ ▼ Mark stations.

◀ ▶ Select other favourites list.

**OK** The marked station is called.

➡ Other favourites lists can only be selected if these contain stations.



**Red button:** Back to the station list.

**Green button:** Scan all stations of the currently selected favourites list.

**Yellow button:** Change the Favourites lists, see page 42.

## Explanation of the favourites lists:

The selection made with the red button (favourites list) is retained until you switch back to the station list with the red button.

If favourites are selected, the name of the favourites list appears in the status display after the station name after changing stations.

## Explanation of the icons following station names:

**T** DVB-T station (digital terrestrial via antenna)

**C** DVB-C station (digital via cable)

**S** DVB-S station (digital via satellite)

**T** Coded station

**CI+** CI Plus coded station

**A** Locked station (see Parental lock on page 52)

# Selecting Audio/Video Source

## Select the AV source via the AV selection

➡ In normal TV mode, without other displays:



Call **AV selection**.



▲ ▼ Select desired connection, **OK** switch over.

If the selected AV source provides a signal (picture), it should be visible now.

For the **VIDEO** selection the set switches to programme place 0 (signal source antenna/cable (analogue), factory setting channel E36). The TV set shows the signal of a provider via antenna (see page 92). The channel can be changed as required (see page 40).

## Select the AV source via station list

➡ In normal TV mode, without other displays:



**OK** Call the station list.

If the favourites list is displayed, switch to the station list first.

The connections are always at the beginning of the list in numerical sorting.

The connections are sorted into the list in alphabetical order in alphabetic sorting.



▲ ▼ ◀ ▶ Select connection.

**OK** Switch over.

# Daily operation

## Adjusting the sound

### Switching sound off/on



Sound off.

Sound on: Press the button again or increase the volume using **V+**.

### Setting the volume

**V+ / V-** Volume louder / quieter.



The volume bar will be shown briefly if no other menu is displayed.

### Call Sound adjustment



Call **Sound adjustment**.

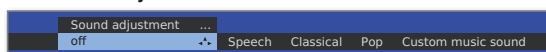

Select sound adjustment by pressing several times.

or:



◀ ▶ Select sound adjustment.

### Additional sound settings

⇒ As long as the volume bar or the selection of the sound adjustment is still visible:



▲ Call additional sound settings.

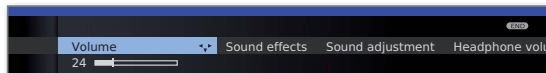

◀ ▶ Select sound setting,  
▼ go to the menu line below.

◀ ▶ Make changes.

### Sound settings via the TV menu

⇒ In normal TV mode, without other displays.



**MENU:** Call **TV menu**.



◀ ▶ Select **Sound**,  
▼ go to the menu line below.

◀ ▶ Select desired sound setting (right column),  
▼ go to the menu line below.

◀ ▶ Make changes.

### Explanations of the sound settings:

**Sound via** Playback over the TV speakers or an external hi-fi amplifier. The menu item **Sound via** only appears if **HiFi/AV amplifier or TV speakers (switchable)** is set in the audio components wizard.

**Sound effects** Set sound effects Stereo, Panorama, 3D Surround. **Panorama** gives the stereo sound a virtual base widening. **3D Surround** converts a stereo signal into a virtual surround signal.

**Sound adjustment** Speech, Classical, Pop, Custom music, and Custom film sound.

**Audio commentary volume** Set the volume of the audio commentary to be relative to the volume of the programme being transmitted. Should negative values result (those in the area of **-50... -1**), the audio commentary is quieter than the programme sound. Should positive values result (those in the area of **+1... +50**), the audio commentary is louder than the programme sound. If the value **0** results, then the audio commentary is at the exactly the same volume as the programme sound.

The menu item only appears if audio commentary is activated (see page 38) and is offered by the current station. Additionally, the **Loudspeaker sound** or **Headphone sound** must be set to **normal + audio commentary** must be switched on (see next page).

**Headphone volume** Adjust the headphones volume.

**Loudness** Proper boost of bass and treble tones at low volume.

**Sound-picture synchronisation** If the sound does not exactly match the picture, you can correct it here. If you move to the left in the bar you delay the sound in relation to the picture. If you move to the right you accelerate it in relation to the picture. The sound is adapted in time steps of 10ms each. The Sound-picture synchronisation menu item only appears for DVB stations.

**more ...** Call with **OK** (see next page).



# Daily operation

## Explanations of the sound settings:

### more ...

**Loudspeaker/ Headphone sound** For analogue stations: In the case of programmes with twin sound, you can select separately between Mono/ Stereo or Sound 1 or Sound 2 for the loudspeakers and the headphones.

For DVB channels: You can choose here if you wish to listen to a special soundtrack for the visually impaired over the speakers. This soundtrack uses an audio commentary to describe the action taking place on-screen.

The menu item only appears if an audio commentary is offered by the current channel.

**Auto Volume** Reduces volume differences, e.g. for advertisements that are too loud.

**AV output signal** You can indicate here which sound is output via the AV socket for dual sound programmes: Sound 1 (e.g. main language), sound 2 (e.g. foreign language), or sound 1+2 (both simultaneously).

**Maximum volume** Determining the maximum volume that can be set.

**max. switch on volume** Specify the volume that is set when switching on the TV set with the mains switch.  
If the volume is higher when switching the TV set to the standby mode than specified here, then it is reduced automatically to the fixed maximum switching on volume when it is turned on again.

**Volume adjustment for current station** The volume can differ according to the individual stations. If the sound is too loud or too quiet in relation to other stations, adjust the volume. When the menu is open, you can select the stations one after another with **P+/P-** and adjust every single station conveniently.

**Balance** Set stereo balance so that the volume impression is identical on the left and right.

**Auto speech detection** If the automatic speech detection is activated, the sound of the current programme is automatically output with optimum comprehensibility when speech is detected.



# Daily operation

## Adjusting the picture



**MENU:** Call TV menu.



- ◀ ▶ Select **Picture**,
- ▼ go to the menu line below.

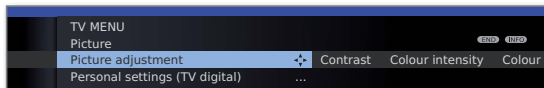

- ◀ ▶ Select the desired picture function,
- ▼ go to the menu line below.
- ◀ ▶ Make changes.

### Explanations of the picture settings:

**Picture adjustment** You can switch between three fixed picture setting variants and the three personal picture values that you have set here (see page 34).

**Contrast** The contrast setting depends on the brightness of the room. The brighter the surroundings the higher the contrast should be set.  
The power consumption of the TV set is directly dependent on the value set here (see also page 21).

**Colour intensity** Set the colour intensity to suit your personal taste. The colours should appear natural.

**Colour temperature** Here, you can give the TV picture a warmer or colder hue according to your personal taste.

**Brightness** Set the brightness so that the black areas of the picture only just appear black.

**Sharpness** Here you can adjust picture sharpness to obtain the best definition.

**Digital Noise Control (DNC)** With active DNC (Digital Noise Control) you can eliminate or reduce picture noise.

**more ...** Call with **OK** (see right hand column).

### Explanations of the picture settings (continuation):

**Image+ Active** Picture improvement on/off and demo mode for Image+ Active.

**Auto dimming - Video (VBD+)** If this automatic dimming (“Video compensating Backlight Dimming”) is active then, dependant on the current video content, the background lighting is reduced and concurrently the video signal is enhanced resulting in improved contrast to your television picture. This will also reduce the power consumption of the TV.

**Auto dimming - Room** If this auto dimming is active then the television picture contrast is automatically reduced when the room brightness diminishes (Optical Power Control – OPC). This will also reduce the power consumption of the TV.

**Film quality impr. (DMM)** DMM reduces jolt in rapid picture object movements and rolling text displays. This applies especially for movies.

**Auto format** Automatic detection and setting of the picture format for Cinemascope or widescreen movies.

**Picture format** Set picture format (see page 34).

**Move picture up/down** Move picture vertically (see page 34).

# Daily operation

## Selecting the picture format



Press the **Picture format button** until the desired picture format is set or press

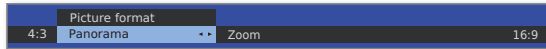

◀ ▶ to select the desired picture format.

The **Panorama** picture format can be set between proportionally correct and format filling display. Black bars are visible on the left and right of the picture in the proportionally correct display.



Switch: Keep the **M button** on the TV pressed, at the same time, press the **Picture format button** on the remote control briefly.



Reset: Press the same button combination again.

## Explanations of the picture formats:

▣ The setting options depend on the transmitted picture content.

16:9 Proportionally correct display of 16:9 broadcasts.

4:3 Proportionally correct display of 4:3 broadcasts.

**Panorama** Proportionally correct or format filling display (as-delivered state) of 4:3 broadcasts on the 16:9 screen. Station logo and subtitles remain visible.  
See above for switching the Panorama mode.

**Zoom** Proportionally correct display. Maximum picture magnification.

**PALplus** Is a 4:3-compatible 16:9 picture broadcast supplied by the station which is detected automatically.

If a high resolution video signal is displayed on the TV set or fed in via the interfaces PC IN, HDMI1 or HDMI2, the picture formats 16:9 PC, 16:9 TV, 16:9 Zoom, 4:3 PC, 4:3 TV and 4:3 Zoom can be set.

In the PC formats, the complete picture content will be shown. In the TV formats a small part of the picture is cropped. This may be necessary to hide possible interference at the edge of the picture, which arises from the signal supplied.

## Move picture vertically



- ▣ In normal TV mode without other displays.
- ▲ ▼ Move picture up/down.



To show subtitles or news tickers which have been cut off, the picture can be moved up or down in the picture formats **Panorama**, **Cinema** and **Zoom** (not with high resolution signal) with the **arrow buttons** ▲ ▼.

## Presettings / Personal settings for picture adjustment



**MENU:** Call TV menu.



- ◀ ▶ Select **Picture**,  
▼ go to the menu line below.
- ◀ ▶ Select **Picture adjustment**,  
▼ go to the menu line below.

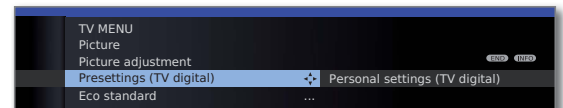

- ◀ ▶ Select **Presettings** or **Personal settings**.  
▼ For presettings, go to the menu line below.
- ◀ ▶ Select the desired presetting for the picture.  
**OK** Confirm selection.

## Explanations for Picture adjustment:

If you select **Presettings**, the picture settings for the signal input group currently active are set to predefined values. See Glossary for an explanation: **Signal input groups**.

Your own settings for contrast, colour intensity, colour temperature, brightness, sharpness and digital noise suppression are saved in the personal values. At the same time, you have your own personal values for each signal input group.

All picture and sound adjustments can be reset to the default values in one step for all signal input groups in the index of the TV set under **Reset picture/sound** or **Factory settings picture/sound**.

<sup>1</sup> Depending on the settings selected.

# Daily operation

## Button functions

Every operating mode of the TV set (TV, Radio, MediaPortal, Teletext, EPG, PIP, and DR archive<sup>(1)</sup>) has its own menu and own functions for the coloured buttons.

The function of the coloured buttons is shown at the bottom of the menus and wizards. Below, some of the functions are listed which you need in TV mode for the daily handling of your TV set.

### Coloured buttons in TV mode



➡ In normal TV mode, without other displays.

**Red button:** Freeze on/off;  
Call DR archive<sup>(1)</sup>

**Green button:** Open the **Teletext functions** menu<sup>(2)</sup>.  
You can select **Subtitles** and your **Personal text pages** via the **Teletext functions** menu. The operation of subtitles depends on the station selected.

Subtitles **Subtitles analogue stations:**

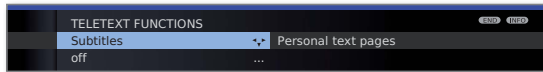

- ◀ ▶ Select **Subtitles**,
- ▼ go to the menu line below.
- ◀ ▶ Select the size of the teletext subtitles,  
**OK** show teletext subtitles  
(display only if subtitles are available).

END

**END:** Teletext subtitles off or select **off** in menu.

### Subtitles DVB stations:

- ➡ If the DVB station does not provide any subtitles, the menu item **Subtitles** is greyed out and cannot be accessed with **OK**.
- ➡ The DVB subtitles can also be selected via the status display (see page 38).

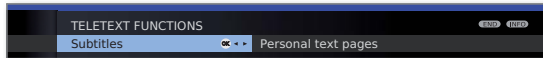

- ◀ ▶ Select **Subtitles**,  
**OK** call.
- ▲ ▼ Select subtitle mode,  
**OK** show/hide subtitles.

### Coloured buttons in TV mode (continuation)

**Green button:** Open the **Teletext functions** menu.

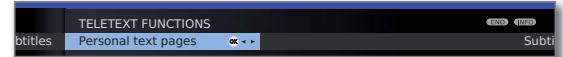

- ◀ ▶ Select **Personal text pages**,  
**OK** call.

Personal text pages



- ▲ ▼ Select text page,  
**OK** view.

➡ If only one text page is defined, no list will be shown and the Teletext page will be opened immediately. To define your personal text pages, see page 48.

**Yellow button:** Go to the last viewed station.  
Use this button to quickly switch back and forth between two stations.

**Blue button:** Show programme info.  
The programme info of the following programme is displayed additionally for DVB stations.

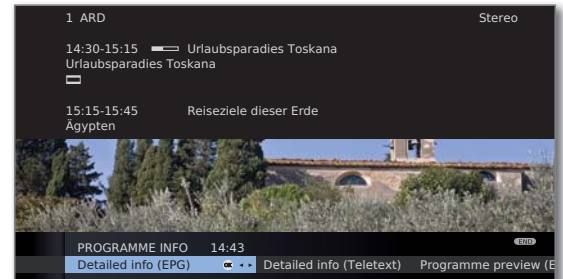

Explanation of the symbols in the programme information:

- Programme in 16:9 picture format
- Programme in high picture definition (HDTV)
- Programme with Dolby-Digital sound
- Broadcast of subtitles for the deaf and hard of hearing
- Programme with youth protection (see **Parental lock – Age-related lock** on page 52).

The symbols may also appear in combinations.

<sup>(1)</sup> Only if an external hard disc is connected (USB Recording).

<sup>(2)</sup> If the audio commentary is active, this button will have other functions, see page 38.

# Daily operation

## Permanent display of time



Press twice in rapid succession:  
Time is shown/hidden permanently.



The permanent display of the time can also be set in the TV menu under **Settings** → **Miscellaneous** → **On-screen displays** → **Permanent clock display** (see page 54).

The display position of the time depends on the selected setting in the On-screen displays menu (ex-factory: bottom). See page 54 for how to change the display position.

## Operation without remote control

### Changing the station on the TV set



+ / - Station up/down.

### Switching radio on or off or switching to radio



R Radio on or switch between TV and Radio.

### Calling the TV menu on the set



M Call **Direct control on TV set** menu,

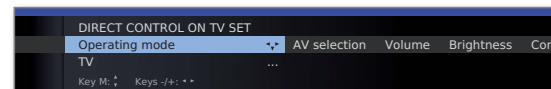

- / + select function.

M or R Go to the menu line below,  
- / + make changes.

M Move up one menu line,  
- / + select other function.

### Explanations of the settings:

Operating mode Switch between TV and radio operation.

AV selection Select AV interface.

Volume Set volume.

Brightness Set brightness.

Contrast Set contrast.  
The power consumption of the TV set depends directly on the value set here (see also page 21).

Picture format Set picture format (see also page 34).

Station Select station +/-.

Service The Service menu item is provided for service purposes by dealers only.

# Daily operation

## Status display

➡ In normal TV mode, without other displays.

INFO

**INFO:** Show status display.

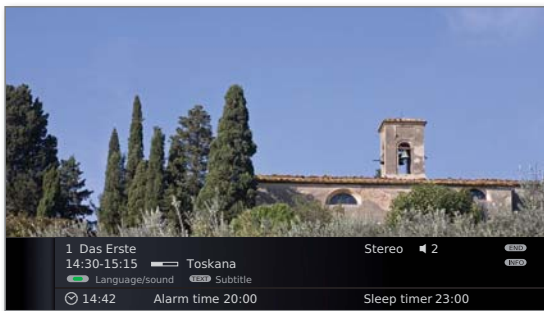

In the upper two lines, you will see the number and name of the station, the title and transmission time of the programme currently showing (if available) and the sound identification signal.

The bar (if available) indicates the progress of the current programme.

If information about the current programme is available, this can be called by pressing the **INFO button** again; in this case the button on the right is displayed.

A menu (see page 38), the time and, if activated, the alarm time and switch-off time appear at the bottom of the screen depending on the DVB station.

The status bar is also shown automatically every time you change channels.

The status bar is hidden automatically at the end of the display time (see page 54 for setting).

If you want to hide the status bar manually before the display time ends, you can only do this with the **END button**.

## Explanations of the symbols in the status display:

Transmitted audio signal:

- Mono** Mono audio transmission analogue
- 2-sound** Two-sound transmission (Sound1/Sound2) analogue
- 1+1** Two-sound transmission (Sound1/Sound2) digital
- Stereo** Stereo sound transmission analogue
- Stereo (AAC+)** Stereo sound transmission (HEAAC)
- ⊕** Stereo sound transmission digital (PCM)
- DD** Digital Dolby Digital sound transmission (DD) 2.0
- DD+** Digital+ Dolby Digital+ sound transmission (DD+) 2.0
- DD+ (AAC+)** Dolby Digital AAC+ sound transmission (HEAAC)
- MPEG** MPEG sound transmission

Transmitted audio channels:

- DD 1.0 / mono**
- DD / MPEG 2.0**

# Daily operation

## Selection possibilities for DVB stations

In the status display additional selection possibilities can be offered for specific programmes depending on the DVB programme provider.

- ➡ If during the status display you press one of the **coloured buttons** or the **TEXT button** then the associated selection menu will be displayed.
- ➡ The selection line is also displayed automatically when a new broadcast with different options to the previous broadcast begins or when you switch stations.

The selection menus are only available as long as the status display is shown. However you can call them again by pressing the **INFO button**.

    **Red button:** Channel selection for multi-channel providers

**Green button:** Language/sound

The sound formats on offer and their designations depend on the programme being broadcast.

**Yellow button:** Time selection



**TEXT:** Subtitles  
The subtitles available depend on the programme being broadcast

## Other setting options for DVB stations

You can make general presettings for DVB stations under **TV menu** → **Settings** → **Miscellaneous** → **DVB settings**.

Subtitle mode	Here you can preset whether a subtitle is always to be displayed as soon as it is offered by the station. A special subtitle for impaired hearing can also be selected. Subtitles are not offered by all stations. Many stations only broadcast subtitles by teletext.
Audio commentary	You can activate a special sound for viewers with impaired vision here (see below).
DVB character set	Select the DVB character set so that the title of the broadcast of your favourite received station or the texts of your CA module are displayed correctly.

## Further explanations of the audio commentary

You can set the system here to always play an additional special soundtrack for the visually impaired whenever one is available. This soundtrack uses an audio commentary to describe the action taking place on-screen. The function can be activated and deactivated in the TV menu (see above) the first time that it is used (see page 22), or by holding down the **green button** for a few seconds.

See chapter **Adjusting the sound** on pages 31 and 32 for more information on how to configure the audio commentary.

## Audio commentary status prompt

➡ Audio commentary is activated (see above).

A quick press of the **green button** will tell you if audio commentary is available.

If audio commentary is available:

You will see a corresponding message on the screen. You will also hear a beep lasting approximately 1.5 seconds.

If audio commentary is not available:

You will see a corresponding message on the screen. You will also hear three short beeps.

# Managing stations

## TV stations

Various options for managing stations are available via the TV menu. For example the description for TV stations. For radio stations the same applies, except that the Radio menu is called in Radio mode (see also page 49).

- Station management is not possible if a programmed timer recording is still pending.
- If at least one station is locked the access code must be entered before Search/Update (see Parental lock on page 52).

### Search/update stations – Search wizard

In the search/update with the search wizard, new stations are searched for which have not yet been stored.

- You have to repeat the initial installation (see page 21) and automatically search for new ones if you want to delete all the existing stations and automatically search for new ones.



**MENU:** Call TV menu.

- ◀ ▶ Select **Settings**,  
▼ go to the menu line below.
- ◀ ▶ Select **Stations**,  
▼ go to the menu line below.
- ◀ ▶ Select **Search wizard**,  
▼ go to the menu line below.

In the upper info text the current search settings will now be displayed:

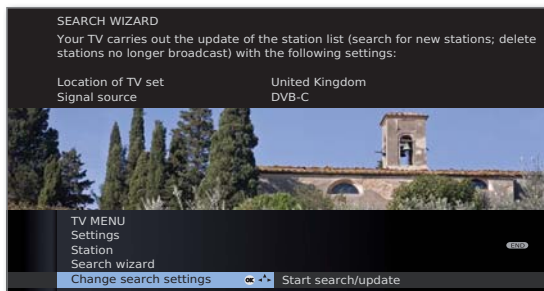

If you want to change these search settings:



- ◀ ▶ Select **Change search settings**,  
**OK** wizard prompts search settings.

If you agree with these settings:

- ◀ ▶ Select **Start search/update**,  
**OK** start search.



**Red button:** Abort current search/update.

### Explanations of some search settings:

**Set location** Select the country for country-specific defaults and station sorting.

**Signal source** Select antenna/cable (analogue), DVB-T, DVB-C or DVB-S<sup>(1)</sup> here depending on which signal source you want to search for new stations.

A configuration of DVB-T and DVB-S<sup>(1)</sup> antennas can also be called by the **green button** (see also page 22 and 23).

- Calling up the DVB antenna configuration causes the **Change search settings** dialogue to be quit. You must call up the dialogue again after finishing the configuration.

### Antenna/cable:

**TV/colour standard** With selection of set location the conventional TV standard/colour standard is the default. This should only be changed if stations with other standards are to be searched.

**Encrypted stations** You can state whether coded stations are to be searched for in the search/update. Select **yes** then coded stations are also searched for. However, these stations can only be received in connection with a CA module and the appropriate Smart Card. Ask your dealer which Smart Card you need to receive certain stations. Handling of the CA module is described on page 55.

### DVB-T

**Search method** If you want to run the station search independently of the channel grid, select **frequency search** for the search method.

### DVB-C

**Settings** With the selection of set location the conventional settings will be preset. Only change this if you know other symbol rates and modulation types or if you have to specify the network ID for your cable network (information available from your cable network provider).

If you want to run the station search independently of the channel grid, select **frequency search** for the search method.

### DVB-S

**Settings** If you want to run the station search independently of the channel grid, select **frequency search** for the search method.

The symbol rate is specified by the satellite provider and normally does not need to be adjusted.

<sup>(1)</sup> Equipment and upgrade options, see page 115.

# Managing stations

## Search for/update stations – handling of new and no longer found stations

The number of new stations found is displayed after the automatic search/update has been completed.



### OK List of new stations found

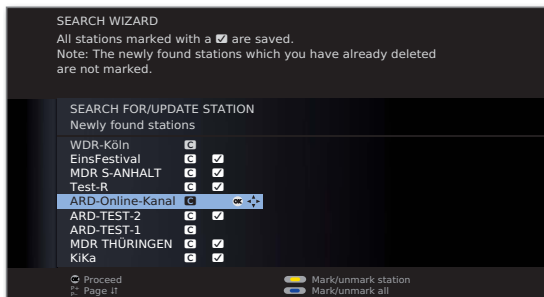

▲ ▼ ◀ ▶ Select station.



**Yellow button:** Mark / unmark station

**Blue button:** Mark / unmark all

**OK** saves the selected stations.

Afterwards, a list of the stations which are saved but which are temporarily not broadcasting or no longer exist is displayed, if available.

The number of the memory location used is displayed in front of the station. Please select the stations you really want to delete.

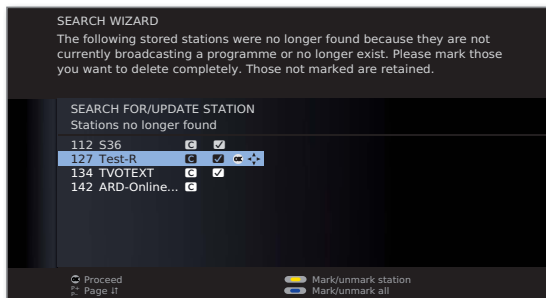

▲ ▼ ◀ ▶ Select station.



**Yellow button:** Mark / unmark station

**Blue button:** Mark / unmark all

**OK** deletes the selected station.



**END:** Exit the search wizard.

## Search/update station – manual search / settings

➡ If you want to adapt the parameters of an existing station, first select the appropriate station.



**MENU:** Call TV menu.



◀ ▶ Select **Settings**,  
▼ go to the menu line below.

◀ ▶ Select **Stations**,  
▼ go to the menu line below.

◀ ▶ Select **Manual adjustment**,  
**OK** call input box.

You can enter or edit the station data in the following lines:

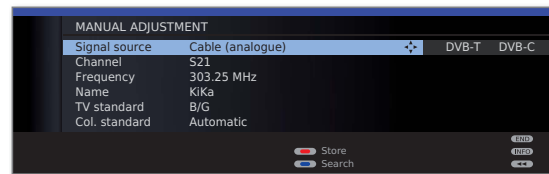

Or:



**Blue button:** Starts **Search** and searches for next station.

**Red button:** Stores station.

➡ Only stations for the selected signal source can be saved which do not yet exist in the station list.

➡ Stations which already exist in the station list for the selected signal source are displayed with their station numbers and names on a grey background. These stations can only be overwritten with the **red button**.

## Explanations of some search settings:

Various settings are possible depending on the selected signal source. Some settings have already been explained in the initial installation (see page 21 onwards).

Signal source Selection of range in which you want to search for the station.

Channel Direct input of channel.

Frequency Direct input of station frequency.

TV stand. Input of station TV standard.  
Ask your dealer in this regard.

Col. standard Input of the station colour standard.  
Ask your dealer in this regard.



# Managing stations

## Change, delete, move, rename, restore station

- ➔ **Change station** can also be called via the station list (page 29).
- ➔ If at least one station is locked the access code must be entered before changing stations start-up (see Parental lock on page 52).
- ➔ In some TV broadcasting networks (e.g. FreeView) you are not allowed to move or rename stations. Use **Favourites** instead.



Call **TV menu**.

- ◀ ▶ Select **Settings**,  
▼ go to the menu line below.
- ◀ ▶ Select **Stations**,  
▼ go to the menu line below.
- ◀ ▶ Select **Change stations**,



In this menu you can delete, move, rename or restore stations.

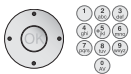

- ◀ ▶ ▲ ▼ or **numeric buttons**:  
Select the appropriate station.  
Scroll with **P+/P-** if necessary.

## Delete station



**Red button**: Starts **Delete** station.

- ▲ ▼ Select several stations to be deleted if necessary,  
**OK** to execute the delete.

## Move station / Change order



➔ Stations can only be resorted within the signal source block.



**Yellow button**: Starts **Move** station.

- ▲ ▼ Mark several stations if needed,  
**OK** selection ended,
- ▲ ▼ Select insertion position from which the selected stations are to be inserted,  
**OK** to execute the move.

## Rename station

- ➔ DVB stations for which the station name is also broadcast cannot be renamed. In this case, the **Rename** function is hidden.



**Blue button**: Starts **Rename** station.

Under the 1st letter of the name you will see a line indicating the current input position.



- ▶ Input position one character to the right (also for blanks).
- ◀ Input position one character to the left.



Input the letters one after another. When using the remote control, press the **numeric buttons** just as on a telephone keypad until the desired symbol is displayed. The available letters are printed respectively on the buttons. See page 106 for a detailed overview of the available characters.



**Green button**: Switch upper/lower case letters.

**Yellow button**: Deletes the character before the input position.

**Blue button**: Cancel rename.



**OK** to save new name.

## Restore stations

Stations which have been deleted from the station list can be restored.



**Green button**: Starts **Restore** stations.



- ▲ ▼ ◀ ▶ Select station,  
**OK** station is restored.

The restored station is sorted in according to its signal source at the end of the respective signal block.

# Managing stations

## Put together / change favourites lists

Each favourites list can contain up to 99 stations. You can put together the favourites lists to suit your requirements (e.g. topic lists). Other persons using this TV set can create their own favourites lists.

The favourites lists also have the advantage that the stations of different signal sources can be stored in the order you wish.

⇒ **Change favourites** can also be called via the favourites list (page 30).

MENU



**MENU:** Call TV menu.

◀ ▶ Select **Settings**,  
▼ go to the menu line below.

◀ ▶ Select **Stations**,  
▼ go to the menu line below.

◀ ▶ Mark **Select/change favourites**,  
**OK** calls list of all stations and last active favourites list.



**Green button:** Select the next favourites list.

## Rename favourites list

⇒ Favourites list (right column) must be selected.  
If not, change the list with ▶ .

**Blue button:** Starts **Rename favourites list**.



Enter new name (same procedure as for rename station, see page 41).



**OK** to save new name.

## Add station to favourites list

⇒ All stations (left column) must be selected.  
If not, change the list with ◀ .



**P+/P-** Scroll in the pages of the station list if necessary.



▲ ▼ Mark station or select station with the **numeric buttons** (for alphabetical station sorting enter the initial letter) which is to be transferred as a favourite to the favourites list.



**OK** transfers the station to the favourites list.  
The new station is inserted at the end of the favourites list. Proceed in the same manner with additional stations.

## Delete station from favourites list

⇒ Favourites list (right column) must be selected.  
If not, change the list with ▶ .



▲ ▼ Mark station to be deleted.

**OK** Removes the marked station from the favourites list.

OR:



**Red button:** Starts **Clear favourite list**.



**OK** confirms clear favourites list.

## Move / change order of stations in the favourites list

⇒ Favourites list (right column) must be selected.  
If not, change the list with ▶ .



▲ ▼ Mark station to be moved.



**Yellow button:** Starts **Move station**.



▲ ▼ Select insertion position at which the marked station is to be inserted.

The insertion position can also be selected with the numeric buttons.



**OK** to execute the move.

# Picture in Picture

## Picture in Picture (PIP)

The concurrent display of two different images is referred to as Picture in Picture.

A green frame around the PIP picture indicates that the station selection affects the PIP picture. A white frame means that the operation refers to the main picture. If the frame is blue, the station play is active in the PIP picture.

### Restrictions for the PIP mode:

- The selection and combination options for main screen/PIP screen basically depend on the number of receivers (tuners) of the TV set (see Equipment variants on page 115):  
PIP operation is initially limited to AV-PIP (one station and one AV source). If a satellite tuner is retrofitted, PIP operation from digital satellite picture and picture via antenna/cable (analogue) is additionally possible.
- Picture change and station selection is restricted during recording.

### Starting and ending PIP mode

PIP

Show/hide PIP.

### Select the PIP picture

- The frame is green, if not, press the **green button**.

Select the station as usual.



### Select the station for the main picture

- The frame is white, if not, press the **green button**.

Select the station as usual.

### Function of the coloured buttons in standard PIP functionality

- The frame is green, if not, press the **green button**.

    **Red button:** Freeze picture in PIP on / off.

**Yellow button:** Switches contents of TV picture and PIP picture.

**Blue button:** Start/stop **PIP scan** in the PIP picture.

# Picture in Picture

## Configure Picture in Picture (PIP) mode

You can set different parameters for the picture in picture mode in the PIP menu.

### Open the PIP menu

- ➡ PIP mode started, if not, press **PIP button**.
- ➡ In Standard PIP functionality:  
The frame is green,  
if not, press the **green button**.

MENU

**MENU:** Call PIP menu.

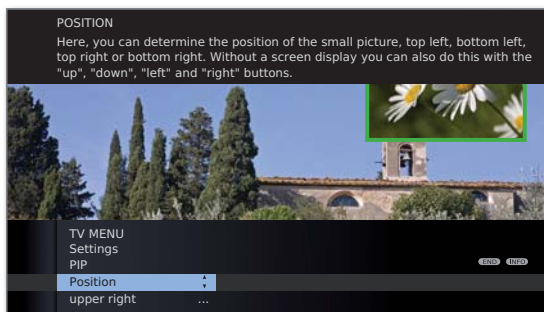

### Explanations of the setting options in the PIP menu:

- ➡ Note restrictions for the PIP mode (see page 43).

**Position** You can determine the position of the small picture here (**upper left, bottom left, bottom right, upper right**). Without a screen display the position can also be changed with the menu control buttons (see below).

### Change position of Small PIP

- ➡ Other than the status line, which may possibly be displayed, no other display is shown on the screen:



- ▲ ▼ ◀ ▶ Move the PIP into a corner of the screen.

The position of the small picture can also be selected under **Position** in the PIP menu (see above).

# Electronic Programme Guide

## Electronic Programme Guide – EPG



EPG stands for Electronic Programme Guide and provides you with on-screen programme details. With the system, as with a printed programme guide, you can learn about the current programme. In addition programmes can be sorted according to certain topics, memorised, and also recordings can be programmed.

### Starting and ending EPG

EPG

**EPG:** Switch EPG on / off.

- ➔ EPG is only available for DVB stations.
- ➔ The first time you start EPG, an assistant will guide you through the necessary presettings.



The display of the programme guide is divided into two branches. The specifications in the upper section limit the scope of the stations displayed in the lower section.



**Blue button:** Switches between the upper default lines **Date, ..., Topics** and the lower programme list.

### Switching and memorizing with the programme list

- ➔ You are in the lower programme list, if not, press the **blue button**.



- ▼ ▲ Select station.
- OK** View / Memorise.

**View** The programme is in progress. The TV set switches to the marked programme.

**Memorise** The programme has not started yet and is memorised. A  will appear in front of the station title. The TV will ask at the beginning of a programme if it should change the channel or switch on from the stand-by mode if the corresponding option of the EPG menu is activated (see page 46).

- ➔ Programmes can also be noted by the timer overview (see page 100).

### Adjusting the programme list

- ➔ The selection is at the top of the specifications, if not, press the **blue button**.



- ▼ ▲ Select **Date, Time, Stations** or **Topics**.
- ◀ ▶ Select defaults within the respective line.



**Example** If you are searching for the next news, select today's date, **17:00** for example for the time, **all** for station and **News** for topics. Then you get a list of all news programmes from 17.00 h onwards in the programme list below it. The type of list of programmes in the programme list depends on the setting of the **sorting** in the EPG menu (page 46).

**Time entry** If the line **Time** is selected, then you can enter the time after which the programmes will be displayed, via the numeric buttons of the remote control. The broadcasts are sorted according to the order of the station list within the selected time window.

**Stations** If a **favourites list** has been selected, only the programmes of stations from the favourites list are displayed in the programme list. A single station can be selected with "...". The Select single station window is opened. After selection, only programmes of the selected single station are displayed.

**Hint** Before pressing the **blue button** to leave the upper selection lines, select one of the preceding lines. If you then switch back to the programme list, you can change this menu line with ◀ ▶, without having to leave the programme list. If you have marked **Time**, then you can enter the time, after which the programmes will be displayed, with the numeric buttons of the remote control.

# Electronic Programme Guide

## Paging through the programme list

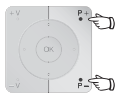

**P+/P-** Page backwards / forwards.

In the entries for **Date** and **Time**, you will see changes in time as well as in date when paging. Scrolling in the programme list is also possible when the selection is at the top of the specifications.

## Calling additional information about the programmes

➡ Brief information about many programmes is displayed below the programme list of the broadcasts.



You can call detailed information with the **TEXT button** if this function is offered by the TEXT icon in the lower left. The symbol explanations are described on page 35.

## Programming a recording for a recorder

- ➡ The selection is in the lower programme list, if not, press the **blue button**.
- ➡ The displayed page of the programme list includes the desired programme, otherwise browse to it or suitably limit via the specifications in the lower section.



▼ ▲ Mark the desired programme.



**RECORD button:** Timer data is called up.

Change or confirm timer data if necessary (see page 99, "The direct way to record").

Then a **red dot** will be displayed in front of this programme as an identification.



**RECORD button:** Deletes the already programmed recording of the red marked programme from the timer. If the timer data have been transferred to an external recorder, then the timer must also be deleted there.

## Configuring EPG

### Start the EPG menu

➡ EPG mode is started, if not, press the **EPG button**.



**EPG:** Call the **EPG menu**.

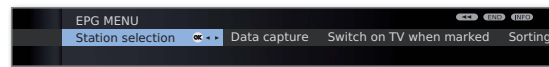

### Explanations of setting possibilities in the EPG menu:

**Station selection** In the **station selection** you can determine for which station in the programme guide information is to be displayed. Programme information is only displayed for stations with  in the EPG list.

With the coloured buttons you can select or remove stations or only select the stations from the favourites lists. Because of the large number of receivable DVB-S<sup>(1)</sup> stations you should restrict the station selection. This reduces the data entry time and increases the clarity in the EPG.

Marking the stations according to reception ranges:

- T** Digital terrestrial stations (DVB-T).
- C** Digital cable stations (DVB-C).
- S** Digital satellite stations (DVB-S)<sup>(1)</sup>.

**Data capture** Here you can switch the data entry for the electronic programme guide (EPG) on and off.

If the data entry is switched on, your TV set tries to update the database overnight (normally between 2 and 5 am) or if required two minutes after switching to stand-by mode. The TV set must be on stand-by for this and not switched off at the mains switch.

The indicator on the TV set lights orange during data entry in stand-by mode.

The data are also updated while you are watching the EPG station.

**Switch on TV when marked** When **yes** is set, the switched off TV switches on automatically from the standby mode at the beginning of a set programme. A screen message appears when switching on. If this is not confirmed within 5 minutes with the **OK button**, the TV switches back off automatically for safety reasons.

**Sorting** The programmes can be sorted either according to their start times (**chronologically**) or according to stations (**corresponding to station list**).

<sup>(1)</sup> Equipment and upgrade options, see page 115.

# Teletext

## Teletext



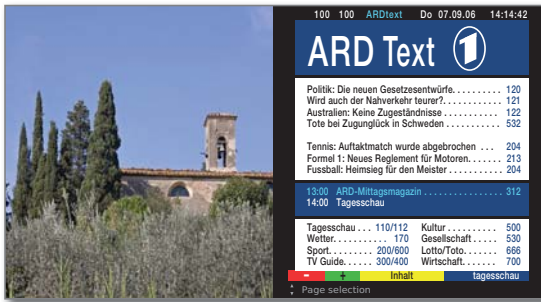

Your TV set supports the two operating systems TOP Text and FLOF. Up to 2,000 pages are stored so that you have quick access.

### Starting and ending Teletext

 Switch Teletext on / off.





### Page selection with the coloured buttons

-     **Red button:** Back to the previously viewed page.
- Green button:** On to next page.
- Yellow button:** To next topic.
- Blue button:** To next range of topics.

The coloured bars (for TOP) or the coloured text (for FLOF) in the second last line indicate which coloured buttons you can use to page through topic areas and topics.

### Teletext page displays

-  **0 AV:** Stop self changing pages.
-  **9:** Enlarge page (press several times).
-  **PIP:** Show / hide TV picture (full screen/split screen).



### Additional page selection possibilities



**1st possibility:**  
Call **overview page 100**.

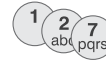

**2nd possibility:**  
Directly enter the page number.



**3rd possibility:**  
➡ The page includes 3-digit page numbers.

▼ ▲ Mark desired page number.

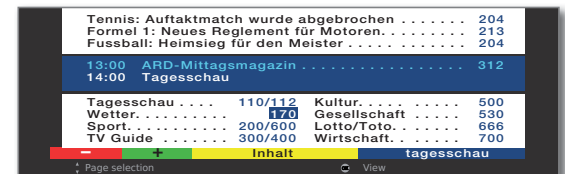

**OK** Call the page.

### 4th possibility:

➡ The page consists of several sub-pages (indicated by the selection option on the last line).



◀ ▶ Page through sub-pages.

### Call TOP table



➡ The table can only be called for stations with the TOP operating system.

**OK** Call **TOP table**.

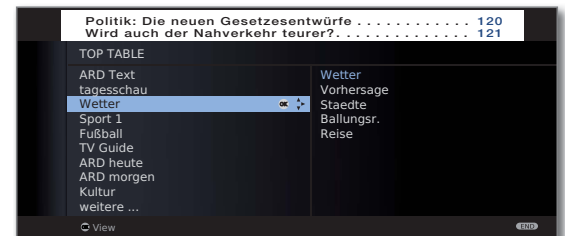

▼ ▲ Mark topic area,  
◀ ▶ select topic column,  
▼ ▲ select topic,

**OK** call the page.

# Teletext

## Programming timer recordings via Teletext

Teletext is started, if not, press the **TEXT** button.



Call the programme pages of the current station.



**Green button:** Go to the appropriate page.



▼ ▲ Select the desired programme, **OK** to programme the recording.

Change the appropriate recording data in the following menu **Timer data** if necessary (see also page 99, "The direct way to record").

**OK** Confirm.

## Changing teletext station

You can change the teletext provider independently of the DVB station you are watching.

The function is only available if two reception channels are available in the TV set (see Equipment variants on page 115). The teletext provider can only be changed if a DVB station was selected as a TV picture

Teletext is started, if not, press the **TEXT** button.



**P+/P-** Select next/previous station. The TV set switches through all the stations in the **Station list** (see page 29) or the current **Favourites list** (see page 30) one after another.

Or:



**MENU:** Call **Teletext menu**.



◀ ▶ Select **Station selection**, **OK** call station.

◀ ▶ ▲ ▼ Select station as in the station list (page 29), **OK** call station.

## Teletext menu

In the Teletext menu you can activate messages, reveal pages and configure the teletext with the **Settings** menu function.

### Starting the Teletext menu

Teletext is started, if not, press the **TEXT** button.



**MENU:** Call the **Teletext menu**.

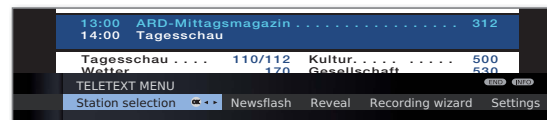

### Explanations of the Teletext menu functions:

**Station selection** You can select the teletext of a different station here (see left hand column).

**Newsflash** The current page is hidden when you activate **Newsflash**. A symbol at the top left indicates that the function is active. If the contents of the message are updated and it is a small newsflash, this is displayed in the TV picture. If it is a full screen page, the symbol is displayed in blue and the page can be called with the **OK** button.

**Reveal** Shows concealed information, e.g. for quiz questions or VPS pages in the programme preview pages.

**Recording wizard** A wizard for **recording** via teletext helps to programme an external recorder or the integrated Digital Recorder, see also left column.

**Settings** Other Teletext menu functions:

**Preview pages** Input of the first teletext programme preview page if this deviates from the factory setting (page 301).

**Sub-title pages** Input of the teletext subtitle pages for every station if this deviates from the factory setting (page 150).

**Personal text pages** Define up to six teletext pages which can be opened later from a list in the menu **Teletext functions** → **Personal text pages** (in TV mode press **green** button, see page 35).

**Character set** Teletext character set can be switched to other languages (Russian, Greek, Polish and Turkish).



## Interactive data services (Digital teletext/MHEG-5)

In some countries, the stations also transmit interactive data services with their programmes (e.g. Digital teletext/MHEG-5), whereby the functions of individual keys are not available or only so to a limited extent.

 The symbol indicates which functions can differ for a loaded application.

In the UK or Ireland, the teletext for DVB-T stations is transmitted as per the MHEG-5 standard. It contains text, graphics, functions and links.

- ⇒ Available in e.g., UK, Ireland, New Zealand.
- ⇒ Digital teletext is not available when DVB subtitles are being displayed.

The operation of these menus depends on the particular provider. Normally after a station is changed, the provider broadcasting the digital teletext makes an introductory offer for this service on the screen via menu selection. Follow these notes.

If no message appears telling you how to switch to digital teletext after switching to another station, press the **TEXT** key. If a selection for DVB subtitles is available, this item must be hidden before.

Depending on the provider's respective offer, you can use the **▲▼◀▶** buttons and the **OK button**, the **coloured buttons**, the **END/TEXT button** and sometimes even the **numeric buttons**.

If you want to close the digital teletext, just select a different station using the **P+/P-** buttons or follow the menu prompts on the screen.

## Radio mode (DVB radio)



The TV set can receive digital radio stations over DVB. In addition you can play the sound from an external device through the TV set via the **audio/AV inputs** of the TV set (see page 50).

- ⇒ The **AUDIO button** has been preset for radio operation in the factory. To change the configuration see page 102.

### Radio mode on



Press **AUDIO button** on the remote control.

Or:



**MEDIA:** Call **MediaPortal**.



◀ ▶ ▲ ▼ Select **DVB radio**,  
**OK** call.



Or:

**R** on the operating ring on the TV set.

You see an information window about the currently set station.

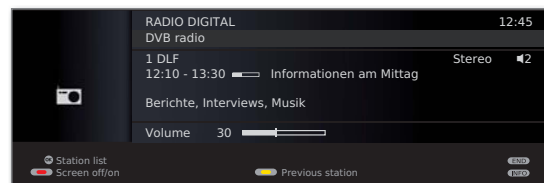

### Setting the volume



**V+/V-** Volume louder / quieter.

Other sound settings are the same as for the volume setting in TV mode (see page 31).

### Sound adjustment



Call **Sound adjustment**.

Other settings as for TV mode (see page 31).

# Digital radio

## Station switching

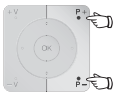

➔ The selection of the stations / favourites is the same as the procedure in TV mode (see pages 29 and 30).

Press **P+/P-** or the **numeric buttons** of the remote control.



Or:

**+ / -** on the TV set operating ring.



Or:

**OK** Call station list / favourites.

## Switching the screen on/off



**Red button:** Switch off the screen.

Switching off the screen reduces the power consumption of the TV set.

The **LED display** on the TV set (see page 10) changes from green to orange.

Switch on the screen with the remote control:

**Red button**, **AUDIO button** or **OK button** (station list is opened).

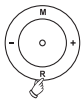

Switch on the screen on the TV set:  
Press **R** on the TV set operating ring.

## Radio menu

In the Radio menu, you can set the sound, search for and store radio stations (automatically or manually), change stations and set switch off/ alarm functions.

The settings are made as described in TV mode.

## Call Radio menu

➔ Radio mode switched on,  
if not, see page 49.

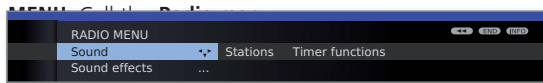

## Switch off radio mode



Press **TV button**

Or:



**END button** on the remote control.

Or:

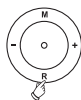

**R** on the operating ring on the TV set.

## EPG – Electronic Programme Guide (radio)

You can also use an electronic programme guide for the DVB radio stations if the radio stations provide programme information.

### Starting and ending EPG

➔ Radio mode switched on,  
if not, see page 49.



**EPG:** Switch EPG on / off.



➔ The EPG functions in radio mode are the same as in TV mode. Read from page 45 onwards for further information.

### EPG configuration (radio)

The EPG settings in Radio mode correspond to those in TV mode (see page 46). If the EPG menu is called up in Radio mode, only radio stations will be included in the station selection.

As already indicated under EPG configuration in TV mode (see page 46), we recommend omitting all radio stations unimportant to you in the EPG station selection for Radio mode (do not highlight with ). This gives you a clearer overview in the EPG, as there are a large number of stations for the signal source DVB-S in particular. The collection of EPG data can also be shorted significantly by this.

# Digital radio

## Audio playback from external devices

You can play the sound of external AV devices (e.g. MP3 players, DVD players) in radio mode.

### Connecting an external appliance (e.g. MP3 player)

Connect the output (jack) of the MP3 player to the cinch audio in sockets L/R (white/red) of the TV set.

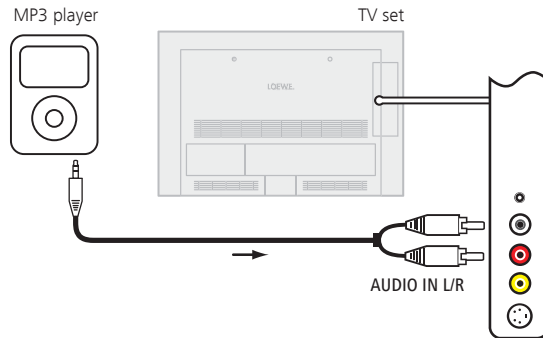

Connection example of an MP3 player

### Select AV input

➡ Radio mode switched on, if not, see page 49.



#### OK Open station list.

The AV inputs are listed before the first radio station in a numerically sorted list.



➡ The selection of the AV inputs is the same as in TV mode (see page 30).

Start playback on the external device after selecting the AV input.

# Other settings

## Parental lock

You can select and set various security options to prevent unauthorised use of the TV set and to protect your children from unsuitable programmes.

### Defining the access code (PIN)

MENU

**MENU:** Call TV menu.



◀ ▶ Select **Settings**,  
▼ go to the menu line below.

◀ ▶ Select **Parental lock**,  
▼ go to the menu line below.



Define a four digit access code (PIN) the first time you open it. The numbers appear in plain text. Note the access code (PIN) well.



**OK** Confirm the access code (PIN).

The **Parental lock** menu is opened.

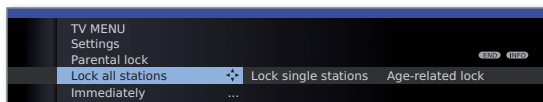

The four-digit access code (PIN) must be entered when the parental lock is opened in future. It appears encrypted (\*\*\*\*) when entering for security reasons.

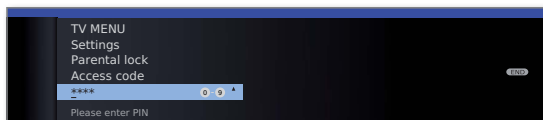

### Code number

The code number cancels all entered PINs. It can be used for example if you have forgotten your PIN. You will find a note about the code number on page 117. Remove this from the manual and keep it in a safe place.

### Explanations of setting possibilities in the Parental lock menu:

**Lock all stations** The TV set is locked immediately the menu is exited. All programmes can then only be watched after entering the access code. The lock can be activated both **Immediately** and for a **Daily** defined period. The lock remains active until it is switched off in the menu.

**Lock single stations** You can lock / unlock individual or all of the stations in the station list specifically. The lock remains active until it is switched off in the menu.

**Age-related lock** Some DVB stations also broadcast an age classification. If the age set here is below the broadcast age limit, the programme can only be watched after entering the access code.

**Change access code** You can change your access code at any time. Enter the new access code in place of the old one.

**Deactivate** All set parental locks (locked stations, age-dependent locks, locked films in the DR archive<sup>(1)</sup>) are cancelled. The current secret code is deleted. When the parental lock is reactivated all the previous parental locks are set again automatically.

**Reset** All currently set parental locks are finally cancelled. The secret code is deleted.

### Protection of minors for CI Plus programmes

Youth-protected broadcasts of programme providers with CI Plus encoding possibly require you to enter the secret number (PIN) of the CA module.

We recommend selecting the secret number of the TV set according to the secret number of the CA module, since the secret number of the CA module cannot be changed. This means that you must only remember one secret number.

<sup>(1)</sup> Only if an external hard disc is connected (USB Recording).

# Other settings

## Timer functions

This menu offers you convenient alarm services. Programmed alarms are also active when the TV set has been switched off to standby.

If the TV set switches on from the standby mode by alarm, a screen message appears. If this is not confirmed within 5 minutes with the **OK button**, the TV switches back off automatically for safety reasons.

The TV set can also be switched off automatically at certain times. A screen warning appears one minute before automatic switch off. The automatic switch off can be interrupted by pressing any button.

### Call Timer functions



**MENU:** Call TV menu.



◀ ▶ Select **Settings**,  
▼ go to the menu line below.

◀ ▶ Select **Timer functions**,  
▼ go to the menu line below.

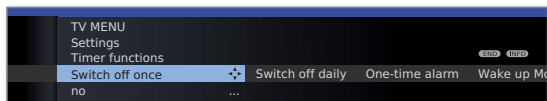

◀ ▶ Select the desired setting.

### Explanations of setting possibilities in the Timer functions menu:

**Switch off once** The set switches to the standby mode automatically at the specified time.

If a time is specified which has already passed on the same day, the set switches off at this time the next day.

**Switch off daily** The set regularly switches to the standby mode automatically every day at the specified time.

**One-time alarm** The set alerts you once today at the specified time. If a time was specified which has already passed on the same day, the alarm is saved for the next day.

**Wake up Mon-Fri** The set regularly alerts you from Monday to Friday at the set time.

**Wake up Sat** The set alerts you regularly every Saturday at the specified time.

**Wake up Sun** The set alerts you regularly every Sunday at the specified time.

### Explanations of setting possibilities in the Timer functions menu:

**Wake up with signal** Specify whether the TV set switches on in the event of an alarm from the standby mode in **TV** or **radio mode** with the respectively last active station.

**Wake up signal volume** Set the desired volume of the alarm tone. The alarm tone is emitted as a continuous tone as a guide during the setting.

## Language

Specify the language for all menus in the TV set in the language menu. The language for the DVB subtitles and the film language can be set for DVB programmes.

### Call language



**MENU:** Call TV menu.



◀ ▶ Select **Settings**,  
▼ go to the menu line below.

◀ ▶ Select **Language**,  
▼ go to the menu line below.

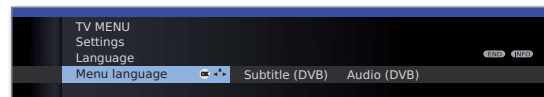

◀ ▶ Select the desired setting.

### Explanations of setting possibilities in the Language menu:

**Menu language** You can change the menu language here. The menu language can be changed with the index (siehe Seite 15).

**Subtitle (DVB)** If subtitles are provided by the DVB station, you can set your desired language in advance here. If this is included in the range of languages of the station, it will be shown automatically.

You can also specify an alternative language under this menu item, in case your chosen language is not offered by the station

**Audio (DVB)** Specify your desired film language in advance here. If this is included in the range of languages of the station, it will be shown automatically.

You can also specify an alternative language under this menu item, in case your chosen language is not offered by the station.

# Other settings

## On-screen displays

You can select different settings in this menu which affect the on-screen displays.

### Call On-screen displays

MENU

**MENU:** Call TV menu.



- ◀ ▶ Select **Settings**,  
▼ go to the menu line below.
- ◀ ▶ Select **Miscellaneous**,  
▼ go to the menu line below.
- ◀ ▶ Select **On-screen displays**,  
▼ go to the menu line below.

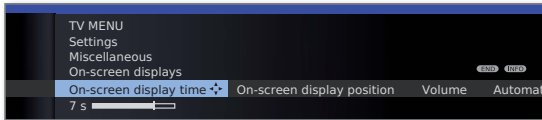

- ◀ ▶ Select the desired setting.

### Explanations of setting possibilities in the On-screen displays menu:

**On-screen display time** Here you set the duration of the display, e.g. for the volume or the station display when changing stations. The duration can be set between 2 and 9 seconds.

**On-screen display position** You can select between an upper and a lower display position so that other displays (subtitles) are not concealed.

**Volume** Here you set whether or not the change in the volume should also be displayed visually on the screen.

**Automatic info** Select **yes** here if you want to be able to see the additional help permanently in the upper part of the screen while navigating the menu. Also see page 15 for further information.

**Permanent clock display** The time can be displayed permanently with this menu item or by pressing the button twice in quick succession (see also page 36). It is always visible as long as no other display is made.

**Automatic hint after switch to HDMI** If you switch to an HDMI programme place to which a Digital Link HD-capable device is connected (see also page 94), a reference to the adapted function of the remote control always appears when **yes** is set.

## Time and date

If you receive a station with teletext after switching on the TV, the time and date are recorded automatically. The date may have to be entered manually for some stations.

Enter the time and date manually if you receive station without teletext.

### Call Time and date

MENU

**MENU:** Call TV menu.



- ◀ ▶ Select **Settings**,  
▼ go to the menu line below.
- ◀ ▶ Select **Miscellaneous**,  
▼ go to the menu line below.

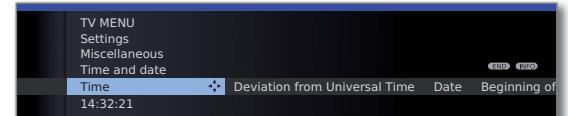

desired setting.

### Explanations of setting possibilities in the Time and date menu:

► If a definite time has been identified by the TV set (dependent on the channel), certain menu items may not be available.

**Time** Enter the time (00:00 to 23:59) with the numeric buttons of the remote control.

**Deviation from Universal Time** The current time at the Greenwich Meridian 0 is to be understood as world time. The time shift in relation to this time must be given in hours (-11 to +13) (with the buttons ◀ ▶ or the numeric buttons on the remote control). Summer time is ignored.

**Date** Enter the date (day.month.year) with the numeric buttons on the remote control.

**Beginning of daylight-saving time** Enter the date on which the time is switched over to summer time if it deviates from the automatically calculated date.

**End of daylight-saving time** Enter the date on which the summer time ends if it deviates from the automatically calculated date.

# Coded Stations

## Conditional Access module (CA module)

In order to receive coded digital stations, a Conditional Access module (CA module) and a Smart Card must be inserted in the CI slot of your TV set (see page 11).

The CA module and the Smart Card are not part of the TV set's scope of delivery. They are usually available from your dealer. Loewe does not provide any guarantee for the functioning of the CA module.

The TV set must first recognise and set up the CA module during initial operation. Therefore, it can take up to a minute until decoding starts during initial operation.

### Inserting the Smart Card into the CA module

Push the Smart Card into the CA module as far as it goes so that the side with the gold coloured contact chip is facing the side of the CA module marked with the provider's logo. Note the direction of the arrow printed on the Smart Card.

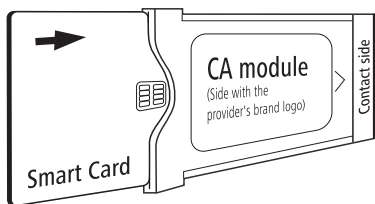

### Inserting the CA module in the CI slot

➡ Switch off the TV set's mains switch.

Remove the cover from the rear of the set.

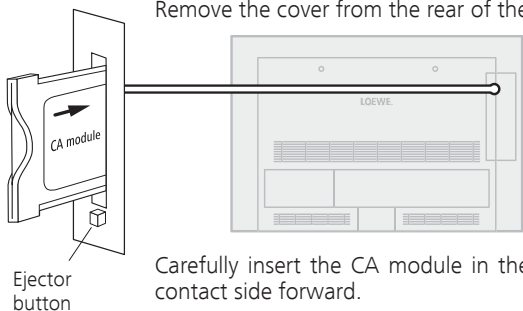

Carefully insert the CA module in the CI slot with the contact side forward.

If you are standing in front of the TV set (display) then the logo on the CA module must be pointing to the rear. Do not use force. Make sure the module is not twisted in the process. If the CA module is correctly installed, the ejector button protrudes a little further.

Replace the cover.

### Searching for encrypted stations

➡ The search wizard must only be started if the setting option **no** has been selected during first installation in the search for encrypted stations and no CA-module was inserted.

MENU



**MENU:** Call TV menu.

◀ ▶ Select **Settings**,  
▼ go to the menu line below.

◀ ▶ Select **Stations**,  
▼ go to the menu line below.

◀ ▶ Select **Search wizard**,  
▼ go to the menu line below.

◀ ▶ Select **Change search settings**,  
**OK** wizard guides you through the search settings.

See page 39 for a description of the search settings.

### Calling CA module information

➡ This menu is only available for digital stations and when a CA module is plugged in.

MENU



**MENU:** Call TV menu.

◀ ▶ Select **CA module: xxx**,  
**OK** call information.

The content of this menu depends on the provider of the CA module.

The CA module information can also be called up in the **TV menu** under **Settings** → **Other** → **CA module: xxx** (xxx corresponds to the CA module provider).

### Removing the CA module

➡ Switch off the TV set's mains switch.

Remove the cover from the rear of the set.

Press in the ejector button on the appropriate module drawer, the module is released.

Remove the module from the set.

Replace the cover.

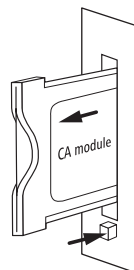

## General information on Media+

You can access your photos, videos and music on your personal USB storage devices using **MediaHome**.

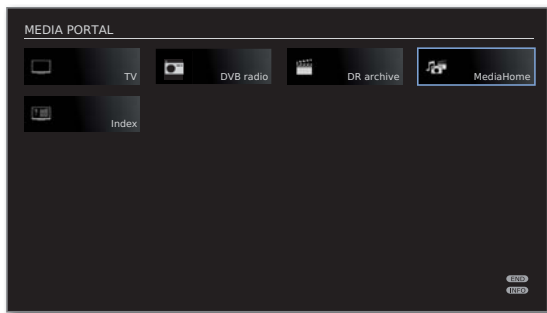

## Playing music and videos, displaying images

**MediaMusic:** see page 61.

**MediaPhoto:** see page 62.

**MediaVideo:** see page 63.

## Quit media

MEDIA

Call **MediaPortal** and select other function (see left column).

Or:

TV AUDIO

Press **TV** or **AUDIO button** for changing to TV or radio mode<sup>(1)</sup>.

Oder:

END

Press **END button** in the MediaPortal main level to change to the last active operating mode (TV, radio).

<sup>(1)</sup> The AUDIO key can be assigned another function (see page 102).



## Media menu

The media menu is used for changing the settings for various types of media (photo, music and video).

⇒ **MediaPortal** is open.

MENU

**MENU:** Call / close **Media menu**.

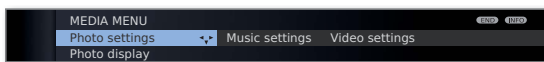

◀ ▶ Select desired menu item,  
▼ go to the menu line below.

◀ ▶ Select the desired setting,  
**OK** call.

### Explanation of the setting possibilities in the Photo settings menu

⇒ The menu can only be opened when a photo is displayed (see page 62).

- Go to ...  
Skip to a definite picture or to the start/end of the current folder.
- Picture display  
Display pictures in optimal size or in original resolution.
- Picture change  
Select how long each picture is to be shown during a slideshow
- Picture  
crossovers  
Three picture transitions can be chosen for the picture change. You can have alternately running picture transitions.
- Picture settings  
You can carry out the picture settings for the photo display here. The settings correspond to the picture settings in TV mode (see page 33).

### Explanation of the setting possibilities in the Music settings menu

⇒ The menu can only be opened when the Music Player is displayed (see page 61).

- Sound settings  
You can carry out the audio settings for playing music here. The settings correspond to the audio settings in TV mode (see page 31).

### Explanation of the setting possibilities in the Video settings menu

⇒ The menu can only be opened when the Video Player is displayed (see page 63).

- Picture settings  
You can make the picture settings for playing videos here. The settings correspond to the picture settings in TV mode (see page 33).
- Sound settings  
You can carry out the audio settings for playing videos here. The settings correspond to the audio settings in TV mode (see page 31).

<sup>1</sup> Only for TV sets with WLAN functionality, see table on page 115.

## MediaHome

Data from storage devices connected directly to the TV set (e.g. USB sticks) are displayed using **MediaHome**.

➡ **MediaPortal** is open.

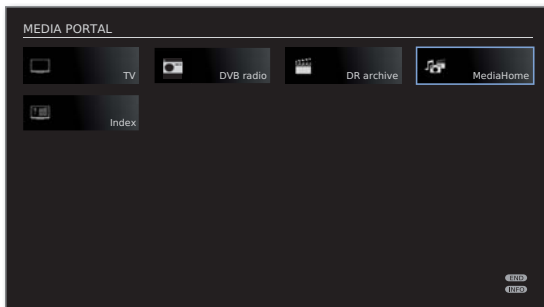

◀ ▶ ▲ ▼ Mark **MediaHome**,  
**OK** activate.

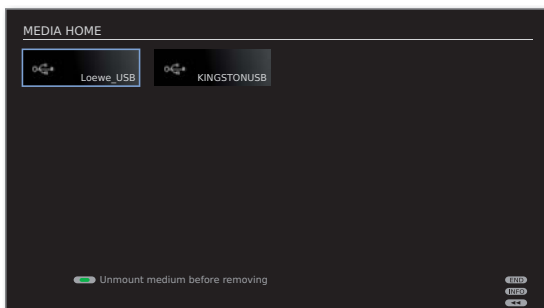

◀ ▶ ▲ ▼ Mark desired media source.  
**OK** Open highlighted media source. All available content will be shown.  
➡ The media sources shown here depend on the devices available/used.

Loewe\_USB Examples of USB storage devices that can be connected to the USB port on your TV set. The exact designation depends on the storage medium present.

➡ Please also observe the notes on page 103 regarding USB sticks!

### Unmounting USB storage media

You should unmount USB storage media properly after use before removing them from the TV set. This avoids a loss of data.

➡ A USB storage medium is marked in **MediaHome**.



**Green button:** Unmount USB storage medium before removing it.

➡ Once unmounted, the USB storage medium cannot be used again until it is reinserted!

# Media+

## General navigation in the media overview

► The graphics on this page typically show a two-column list view. You can switch between the views as required (see page 60).



▲ ▼ Select desired folder.

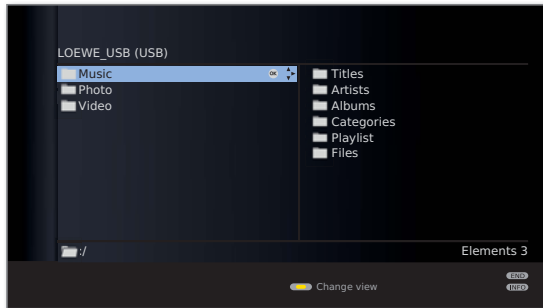

- ▶ Open marked folder. The content of the folder is displayed in the right window.
- ◀ Go back a folder level if necessary.



◀ ▶ ▲ ▼ Repeat procedure if necessary. The content of the selected folder is still displayed in the right window, the previous folder structure in the left window.



▲ ▼ Select media file (example below: music title).  
**OK** Play/display selected media file.

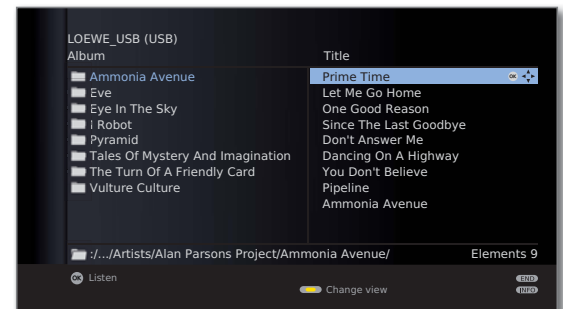

Playing music: see **MediaMusic**, page 61.  
Displaying photos: see **MediaPhoto**, page 62.  
Playing videos: see **MediaVideo**, page 63.

## Change view

You can change the view of the displayed files and folders.

In the Media Overview:

 **Yellow button:** opens **Change View**, and:

 **Green button:** Switches over to two-column list view (see sample figures on page 59).

 **Yellow button:** Switches over to single-column list view (with picture for the element currently selected).



Single-column list - example with music titles

 **Blue button:** Switches over to thumbnail view.

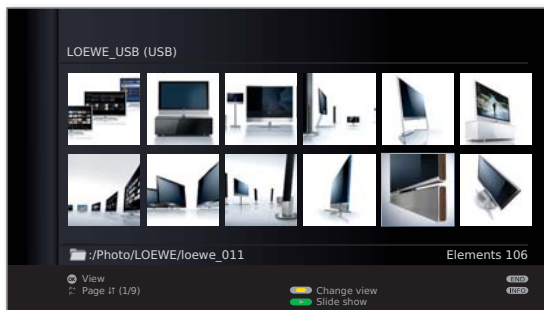

Thumbnails - example with photo overview

## Playing/displaying data from USB storage media

- The uppermost folder level is divided into three fixed categories:
  - Music**
    - with the subfolders **Titles**, **Artists**, **Albums**, **Categories**, **Playlist**, **Files** (see below).
  - Photo**
  - Video**
- The original folder structure of the USB storage medium is retained in the media overview for **Photo** and **Video**. For playing **Music**, the available titles are prepared and offered in the above subfolders.

### Subfolders in Music mode

- Titles:** The music titles found on the USB storage medium are sorted by title name.
- Artists:** The music titles found on the USB storage medium are sorted by the respective artist.
- Albums:** The music titles found on the USB storage medium are sorted by album name.
- Categories:** The music titles found on the USB storage medium are sorted by their respective musical categories (e.g. Jazz, Classical, Pop, Rock) and displayed correspondingly.
- Playlist:** Display and play back any play lists that have been generated on the PC.
- Files:** The music titles found on the USB storage medium will be shown without being especially sorted (in order of file name).

## MediaMusic

➡ A music title is highlighted in the media overview.



OK Play highlighted music title (see right column).

### Play music files

➡ A music title is highlighted.



OK Play music title.

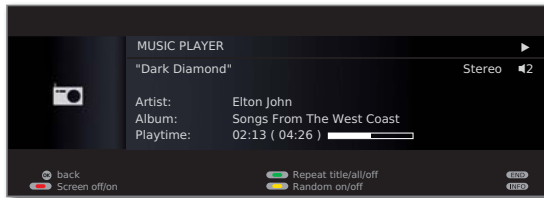

**PAUSE button:** Pause current playback.



**PLAY button:** If playback is paused:  
Continue paused playback.  
For playback in progress:  
Play title from the beginning.



short: Playback previous/next title.  
long: Rewind/fast forward.



OK Return to the overview without ending the current playback.



**STOP button:** End playback and return to overview.

### Explanation of the symbols in the playback window

The symbols at the top right show you information about the current playback.

- ▶ Playback
- || Pause
- ◀◀ Rewind
- ▶▶ Fast-forward
- ↺ Replay current title
- ↻ Replay all titles in the current folder
- 🎲 Random play activated

The bar behind the **playtime** shows you how far the music file has been played.

### Function of coloured buttons during music playback



**Red button:** Switch **screen off/on**.



**Green button:** Repeat individual **title/all** titles/  
Repeat **off**.



**Yellow button:** For music files from local media  
Random play of files in currently selected folder on / off.

## MediaPhoto

➡ A picture is selected in the media overview.

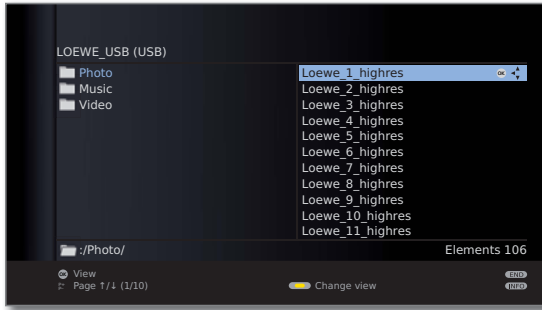

**OK** View marked picture in full screen mode (see below).



**PLAY button:** Start slideshow (see right column).

### Full-screen mode

➡ A picture has been selected.



**OK** Opens full picture mode.

➡ Portrait photos (with the corresponding entry in the Exif files) are automatically positioned correctly for viewing.



Show previous/next picture.



▲ ▼ Rotate picture by 90 degrees to the left/right.

**OK** Quit full-screen mode and return to overview.

### Slide show



**PLAY button:** Start slide show.

➡ from photo overview: Start slide show with marked picture.

➡ in full screen mode: Start slide show with displayed picture.



**PAUSE button:** Pause slide show.



**PLAY button:** Continue slide show.



**STOP button:** End slide show and return to overview.

## MediaVideo

➡ A video is selected in the media overview.

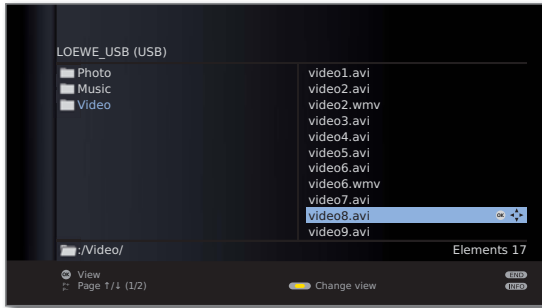

**OK** Play highlighted video.

### Playback

➡ A video is selected.



**OK** Play highlighted video.



**PAUSE button:** Pause current playback.



**PLAY button:** Continue paused playback.



**STOP button:** Stop current playback and return to overview.

### Video status bar

The video status bar provides you with further information about the current playback.



**INFO:** Display/hide status bar/file information/context information.

Pressing the **INFO button** the first time will show the video status bar. Pressing a second time shows the file information for the video. Pressing the **INFO button** again shows the context information with operating instructions. The displayed information is hidden again by pressing again.

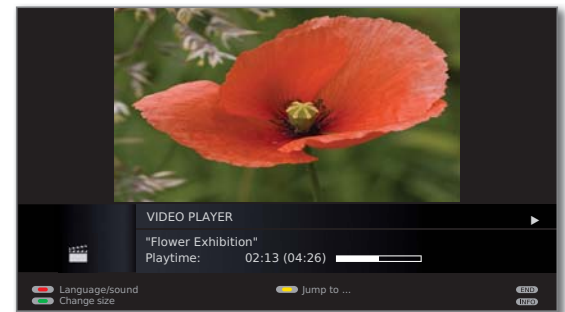

**END:** Close displayed content.

### Explanation of status bar symbols

The symbols (in the status bar top right) show you information about the current playback.

- ▶ Playback
- || Pause
- ◀◀ Rewind (speed 2x, 5x, 10x, 20x)
- ▶▶ Fast-forward (speed 2x, 5x, 10x, 20x)

The bar behind the **playtime** shows you how far the video has been played.

# Media+

## Wind

You can fast-forward/rewind videos to search for desired scenes.



Rewind at double speed.  
Speed 2x, 5x, 10x, 20x.



Fast-forward at double speed.  
Speed 2x, 5x, 10x, 20x.



**PLAY button:** Continue playback.  
▶ Please wait until the videos have loaded into the device.  
This can take a few seconds, depending on the bit rate of the film.

## Jumping

You can jump to any point in the video by entering a time.



**Yellow button:** Open **Jump to .....**

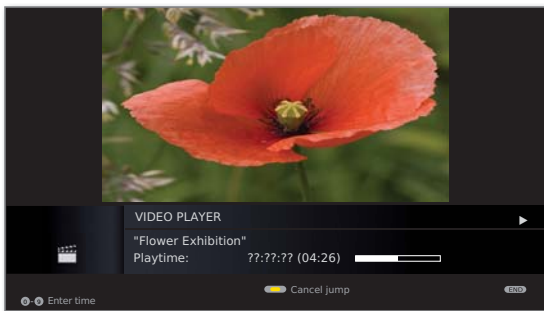

Enter the desired time with the **numeric buttons**.



**OK** Jump to the time entered.



**Yellow button:** Cancel the jump.

## Select language/sound

Video files can contain several audio tracks.



**Red button:** Select **language/sound**.

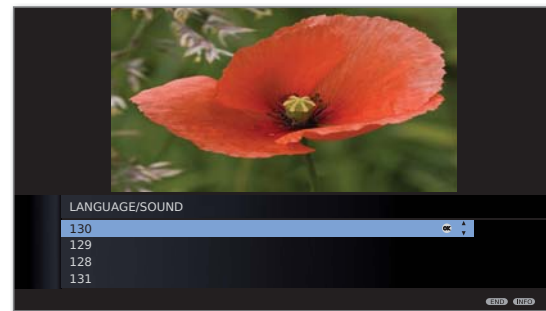

▲ ▼ Highlight the desired sound or language and **OK** selects the audio track.



**END:** Cancel audio track selection.



# Digital Recorder

## About the Digital Recorder system

You can use the Digital Recorder of your Loewe TV set to record programmes on an external hard disc connected via USB (USB Recording).

The Digital Recorder can also process HDTV signals including the audio and auxiliary signals that they contain.

The various ways in which your Digital Recorder can be used are listed below.

### Overview of functions

Digital Recorder function	
Archive recording on the USB storage device (external hard disc)	●
Archive recording of analogue stations	–
Archive recording of digital stations (DVB-C/T/S)	●
Archive playback from USB storage devices (external hard disc)	●
Time shift TV when archive recording is running	●
Copy recorded programmes onto an external recorder	●
Copy recorded programmes from one USB storage device to another	○
Set/delete manual bookmarks	●

- available
- available when at least two external hard disks are connected via a USB hub
- not available

# Digital Recorder

## Digital Recorder archive

You can record movies you want to watch later in the Digital Recorder's archive.

- Recording of analogue stations is not possible.
- Recordings of CI Plus encoded programmes are perhaps not possible or only to a limited extent (see page 88).

If EPG or teletext data are available, the Digital Recorder stores the title and additional information about each programme in the archive.

If additional languages are being transmitted for a DVB broadcast, these are also recorded. DVB subtitles or teletext subtitles are recorded if the recording of subtitles has been activated in the Digital Recorder settings. Display language selection and subtitles as in TV mode.

Start playback of your recordings from the archive.

If bookmarks were set in a recording, these entries are marked accordingly (📌).

Comfortably select your favourite programme for recording from the EPG or teletext and watch the programmes later from the Digital Recorder's archive.

An automatic Delete Manager always ensures there is sufficient recording space for new movies (see page 75).

- **Sort titles**  
You can have the broadcasts displayed according to time, alphabetically or by station name. You can therefore quickly find the recording you want to watch.
- **Rename/edit titles**  
You can change the title of a programme in the archive, if necessary.
- **Parental lock**  
Protect your archive against unauthorised access by using the parental lock feature.
- **Delete protection**  
Set the delete protection for a movie to prevent it from being deleted automatically by the Delete Manager (see page 75).
- **Copy**  
Using time control, copy films from the archive of the digital recorder to the external DVD recorder or onto external hard discs <sup>(1)</sup>.

<sup>(1)</sup> Only when a USB hub is being used.

## TV viewing with time shift

When an archive recording is taking place, you can watch the programme being recorded in time shift TV.

- Time-shifted operation is perhaps not possible or only to a limited extent for programmes of stations working with CI Plus encoding (see page 88).
- **Time shift**  
When a TV programme is being recorded, you can pause it at any time and then use time shift TV to watch it later. The maximum time shift is up to 3 hours.
- **Fast navigation by jumping**  
You can wind and rewind during a film at just the press of a button. The jump distance is adjustable. The **Smart Jump** function also ensures that the jump width is halved each time the jump direction is changed or doubled after three jumps in the same direction (max. 8 minutes). This way you can quickly find a certain spot of the recording.
- **Fast forward and rewind**  
You can fast forward and rewind at three different speeds in the programme you are viewing with time shift.
- **Slow motion**  
You can play a programme which you are watching with a time offset at four different slow motion speeds.
- **Setting bookmarks**  
During a football match, for example, you can flag goals or exciting scenes. With this, you can find your favourite parts again much faster.

# Digital Recorder

## Archive recording

➡ To record encoded programmes, please also read the instructions on pages 87 and 88.

➡ Recording of analogue stations is not possible.

You can play back a pre-recorded programme from the archive whilst another TV programme is being recorded into the archive. You can also play the same programme you are currently recording with a time shift.

- **Immediate recording**

Record interesting programmes directly into the DR archive with the **RECORD button**. The programme is recorded from the point at which the recording function is selected to its end or to the end of the set recording time.

- **Timer-controlled recording**

Comfortably select your favourite programme for recording, from the EPG or teletext. The timer overview has room for 50 entries. Watch the programmes later from the Digital Recorder's archive.

- **Serial recording**

You can conveniently programme series broadcast with alternating start times.

In some broadcast networks (like UK FreeView) you can even let the TV set record series and split events automatically depending on the information provided by the broadcaster. A conflict manager (see page 14) will also automatically try to find alternate instances of conflicting recordings if signalled by the broadcaster (e.g. UK FreePlay).

- **Time shift viewing with archive recording**

If you have programmed recording and come home before it is finished, you can watch the movie with a time shift while the rest is still being recorded.

## Archive playback

All the recorded programmes can be selected in the archive and played. During archive playback, another programme can be recorded into the archive.

- **Fast forward and rewind**

There are three different speeds for winding and rewinding films.

- **Fast navigation by jumping**

You can fast forward and rewind during a film at the touch of a button. The jump width is adjustable (see page 68).

The **Smart Jump** function also ensures that the jump width is halved each time the jump direction is changed or doubled after three jumps in the same direction (max. 8 minutes). This way you can quickly find a certain spot of the recording.

- **Slow motion**

You can use playback at four different slow motion speeds.

- **Bookmarks**

To find interesting scenes in a movie later, you can manually set the bookmarks. In addition, there are also automatically set bookmarks every time a broadcast is changed. You can jump to each of the bookmarks in succession at the press of a button.

- **Cut function**

Unwanted sections at the beginning and ending of a recording are easy to delete.

- **Copying your recordings**

You should burn recordings that you want to save permanently on DVD. Afterwards, you can delete the recording from the archive.

➡ Copying recordings, which originate from a CI Plus encoded station, is perhaps not possible or only to a limited extent (see page 88).

## Technical information

The TV set uses the hard disk file system FAT32. The file system NTFS is not supported. PCs with the operating system Microsoft Windows only support a total hard disk volume of 32GB when formatting on FAT32. Larger hard disks are automatically reduced in their capacity by this. Format external USB disks that you wish to use with the TV set via the **TV menu → Settings → Miscellaneous → Format external hard disk** (see page 86), so as to be able to utilise the hard disc capacity.

Switching off the TV set with the mains switch during operation or an inadvertent disruption to the power supply (e.g. power failure) can cause damage to the hard disc file system and hence loss of the recorded broadcasts. Always first switch your TV set to standby mode (press On/Off button on the remote control or switch-off button in the middle of the operating eye on the TV set), before switching off at the mains switch. Do not disconnect the external hard drive from the TV set during recording under any circumstances.

However, if unexpected problems occur when operating the hard disc, formatting the hard disc may rectify this. Refer to the instructions on page 86.

# Digital Recorder

## Settings

You can make a few settings in the **Digital Recorder menu** to adapt the Digital Recorder to your requirements.

### Call Digital Recorder menu



Call **DR archive**.

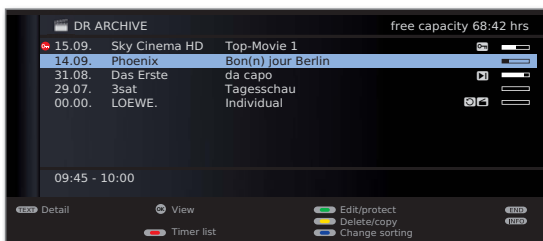

**MENU:** Call **Digital Recorder menu**.

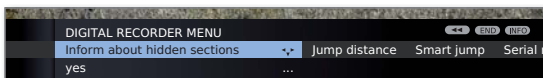

- ◀ ▶ Choose a setting,  
▼ switch to the menu line below.



- ◀ ▶ Set or enter using the **numeric buttons** of the remote control.

### Explanation of the setting facilities

**Select memory medium** Select the storage medium whose accessible content is to be displayed in the archive.

- ➔ The menu item only appears if several USB storage devices are available.

**Inform about hidden sections** If an entry has been hidden in an archive recording, you can be informed by a screen message when skipping a hidden area.

Factory setting: **yes**.

**Jump distance** Set the standard jump width (in minutes) used for jumping forwards or backwards in the film by pressing ◀◀ or ▶▶. Use the numeric buttons on the remote control to enter the time (always two-digit for 01 to 15 min.).

Factory setting: **04 min**.

- ➔ If **Smart Jump** is activated, the jump width can only be set between 1 and 4 minutes.

**Smart Jump** Activate or deactivate Smart Jump function (see page 76).

Factory setting: **yes**.

**Serial recording tolerance** A broadcast programmed with the recording type **Serial** is recorded only if it begins within the programmed start time ± series recording tolerance. Use the numeric buttons on the remote control to enter the time (always two-digit for 01 to 60 min).

Factory setting: **+30 min**.

- ➔ Serial recording tolerance is ignored when recording a programme with auto time control (see page 74).

# Digital Recorder

## Setting the pre-record and post-record time

You can set a pre-record and post-record time for timer recordings made without auto time control (DVB) (see also page 87). This minimizes the risk that a part of the broadcast is not recorded due to the broadcast starting earlier and/or finishing later.

MENU

**MENU:** Call TV menu.



- ◀ ▶ Choose **Recording**,
- ▼ switch to the menu line below.

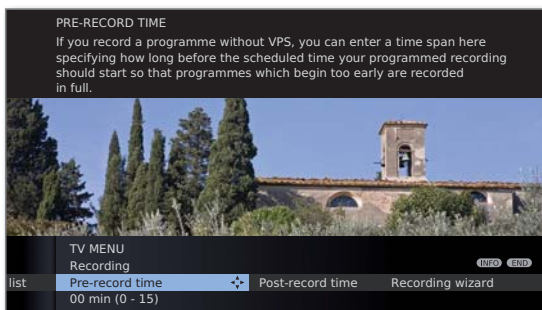

- ◀ ▶ Set **pre-record** or **post-record time**,
- ▼ switch to the menu line below.



Enter the time using the **numeric buttons** (always 2-digit: 01 to 15 mins for pre-record time; 01 to 60 mins for post-record time). Factory setting: pre-record: **00 min**, post-record: **05 min**.

# Digital Recorder

## Archive recording – Direct recording

➔ For recording encrypted broadcasts, please also refer to the information on pages 87 and 88.



Press **RECORD button** briefly: Start direct recording.  
The **Recording duration** selection is called.

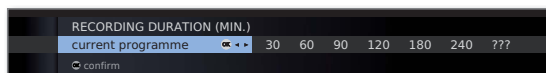

◀ ▶ Select desired recording time.

**current programme:** The broadcast being watched is adopted in the DR archive.



**???:** Manually enter the recording duration with the numeric buttons of the remote control.

**OK** Confirm. Call **Timer data**.

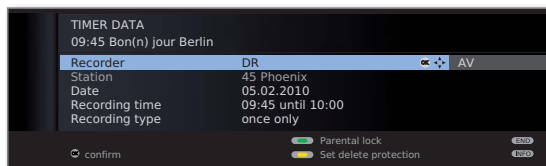

Check the timer data, change if necessary and confirm with **OK**. The recording is started.

See page 74 for explanations of the setting options in the **Timer data** menu.

## One Touch Recording

With One Touch Recording, the recording starts immediately at the press of a button. You only need to specify the recording time. There is no need to select the recorder (e.g. DVD recorder). The broadcast is always recorded onto the external USB hard disc.



Press **RECORD button** longer: Start One Touch Recording.  
The **Recording duration** selection is called.



◀ ▶ Select desired recording time,  
**OK** confirm.

During the archive recording, the bar showing the recording progress is red and the **REC** message is shown for a current archive recording.

## Setting bookmarks during archive recording

During immediate recording or a running timer recording, you can set bookmarks at interesting sections (press the **PLAY button** for a little longer). You will see a screen message. This enables you to find this part of the recording quickly during playback. You can set up to 15 bookmarks per recording.

## Time shift viewing during archive recording



**PAUSE button:** Change to freeze frame.  
The recording is continued in the background.



**PLAY button:** Continue playback.  
You will now see the time-shift archive recording.

Jumping, fast forward / rewinding and slow motion function as described in the chapter **TV viewing with time shift** (pages 76 and 77).



**STOP button:** End time shift and return to the live image.

# Digital Recorder

## Viewing another movie from the archive during archive recording

After you have started the recording, you can also watch a programme you have already recorded.



Call **DR archive**.



▲ ▼ Select recording,  
**OK** view film.

- ▶ If an encrypted programme is recorded with the option **Descrambled recording** → **yes**, the CA module required for decoding is used for the recording. In this case you cannot watch any other encrypted programme from the archive.

## Switching off the TV set during recording

You can switch off the TV to standby whilst recording. The recording is continued in the standby mode. The display on the set shows orange.

- ▶ **Never** switch the TV set off at the mains and do **not** pull out the plug of the TV set out of the socket. Otherwise the recording will be lost!

## Subtitles

Any subtitles that are transmitted can also be recorded (see page 74).

Display recorded subtitles during later playback:



**INFO:** Show status display (see right column)



**TEXT:** Call subtitle selection.



▲ ▼ Select desired subtitles.  
**OK** Show subtitles.

## Stop recording early

You can end a current archive recording prematurely.



Press **STOP button**.



**OK** Stop recording.

The recording process is ended. The material recorded up to this point is saved on the hard disc and can be played back via the DR archive.

You can also end a running recording by deleting the entry in the timer overview or in the DR archive. See page 75 for further information.

## Status display during time shift and archive recording



**INFO:** Show status display.

Display with live picture during an archive recording:

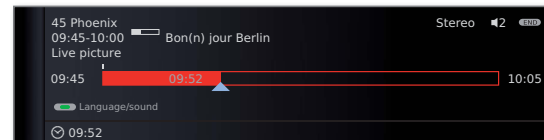

Display with time shift during an archive recording:

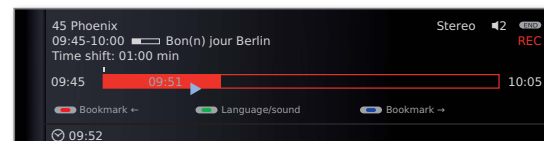

# Digital Recorder

## Archive recording – Timer recording

For recording encrypted broadcasts, please also refer to the information on pages 87 and 88.

You can programme timer recordings for the Digital Recorder conveniently using the EPG, teletext or manually. Up to 50 simultaneous timer entries are possible.

When you have programmed timer recordings, the TV set can only be switched off to the standby mode. **Never** switch the TV set off at the mains and do **not** pull out the plug of the TV set out of the socket. Otherwise no timer recordings can be made!

Programmed timers for the Digital Recorder are displayed in the timer overview.

The code **DR→DR** appears instead of the programme name in front of the entry for scrambled recordings still to be descrambled.

For an explanation of the symbols in the timer list see the chapter **The direct way to record** on page 99.



Call **DR-archive**.

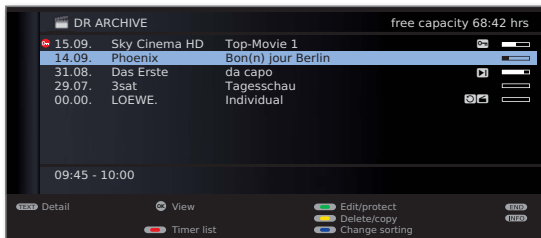

**Red button:** Call **Timer list**.



A red dot with a key symbol appears in front of the entry for scrambled recordings still to be descrambled.

## Programming a timer recording with the EPG



Call **EPG**.

▲ ▼ Flag the broadcast to be recorded.



**RECORD button:** Programme the recording of a broadcast.

Timer data dialogue is opened.

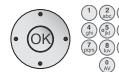
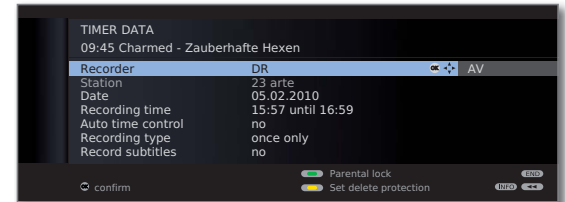

Check the timer data and change it if necessary.

**OK Confirm** timer data. The broadcast is entered into the timer overview.

See page 74 for explanations of the setting options in the **Timer data** menu.

In the EPG a red dot is set in front of the title of the programme. If a broadcast is already marked with a red dot, you can re-delete the programmed timer entry using the **RECORD button**. The red dot disappears.



# Digital Recorder

## Programming a timer recording via teletext

Call the station on which you want to make a timer recording.



**TEXT:** Call teletext.



**RECORD button:** Call first programme preview page.

If not possible, define the preview page in the **Teletext menu** → **Settings** → **Preview page**.



**Green button:** Select the programme preview page which contains the programme which you want to record.



▼ ▲ **Flag the time at which the broadcast starts.**

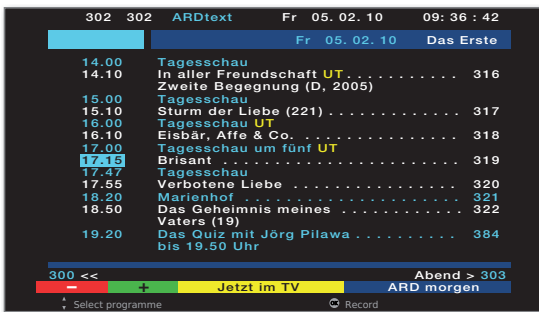

**OK** Programme the recording of a broadcast.

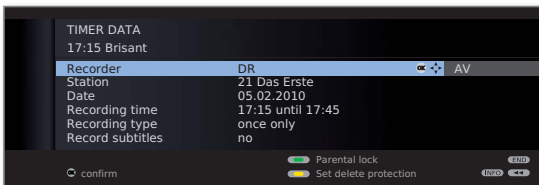

Check the timer data and change it if necessary. Check the recording time and date for broadcasts which last past midnight or begin the following day. The data from the teletext may not be complete.



**OK Confirm** timer data. The broadcast is entered into the timer overview.

See page 74 for explanations of the setting options in the **Timer data** menu.

## Programming a timer recording manually



Call **DR-archive**.



**Red button:** Call **Timer list**.



**Red button:** Call **New entry**.



◀ ▶ **Select Recording.**  
**OK** Call **Recording wizard**.

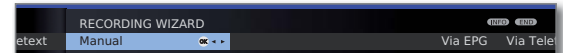

◀ ▶ **Select Manual.**  
**OK** Start programming.



▲ ▼ ◀ ▶ **Select the station or connection socket to be recorded.**

**OK** Accept.

The **Timer Data** menu is displayed.

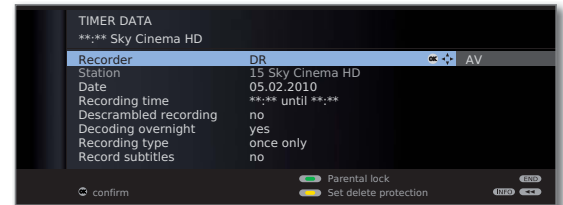

Check the timer data. Enter the date and recording time in any case.

**OK** Confirm. The broadcast is entered into the timer overview.

# Digital Recorder

- ➡ If a DVD recorder was selected as a recording source, start playing the connected device manually from the beginning of the entered recording time.

## Explanations of the setting options in the Timer data menu

- |                       |  |
|-----------------------|--|
| Recorder              | Select the recorder that is to be used. Select <b>DR</b> here to select the Digital Recorder.  |
| Station               | (only available when the selected station can be received via different signal sources, e.g. DVB-T and DVB-S)<br>Select the signal source for the recording.   |
| Date                  | Date of recording.   |
| Recording time        | Time of the recording.   |
| Auto time control     | (only available for some DVB stations and when recording via EPG, see also page 86).<br>Use automatic time control, <b>yes / no</b> .<br>➡ Auto time control must be set to <b>yes</b> to use UK FreeView+ functionality.  |
| Descrambled recording | When recording scrambled stations, you can define here whether the station is to be descrambled during the recording, if possible. If you select <b>yes</b> , you cannot watch another coded station during recording because the CA module is used for the recording.<br>Hint: Select yes if you do not want to watch another coded station during recording. You are then saved a subsequent descrambling.<br>➡ When recording from CI Plus scrambled programmes the <b>auto time control</b> cannot be used due to technical reasons, if here <b>yes</b> is chosen. |
| Decoding overnight    | (only with presetting <b>Descrambled recording → no</b> ).<br>If you choose the setting <b>yes</b> , the programme will be automatically decrypted at 02.00 the following day (CA module must be plugged in). Choose <b>no</b> if you would like the decryption to take place at another time. Enter the decryption time of your choosing with the remote control.   |

## Explanations of the setting options in the Timer data menu (continued)

- |                        |  |
|------------------------|--|
| Programme provider PIN | (only for recording CI Plus protected broadcasts)<br>Enter the CA module's parental-lock PIN. Refer also to page 88.   |
| Recording type         | Select <b>once only</b> , <b>Mon-Fri</b> , <b>daily</b> or <b>weekly</b> . For timer recordings via EPG <b>Serial</b> is available in addition.  |
| Record subtitles       | Select whether broadcast subtitles are to be recorded too.   |
| Lock movie             | Only allow later playback of this recording after entering the PIN number (child lock). Press <b>green button</b> .<br>➡ If a PIN still hasn't been entered under <b>TV menu → Settings → Parental lock</b> , the <b>Parental lock</b> will at first be activated. |
| Set delete protection  | Protect against automatic deletion by the Delete Manager. Press <b>yellow button</b> .   |

# Digital Recorder

## Delete programmed timer entries

Use this function in the timer overview if you want to delete recordings already programmed or end a running timer recording.



Call **DR-archive**.



**Red button:** Call **Timer list**.



▲ ▼ Mark the timer to be deleted.



**Yellow button:** Delete timer entry.

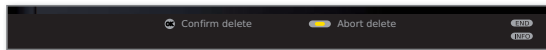

**OK** Confirm.

► The letters of a timer currently active are red. If you delete this timer, the recording is stopped.

## The Delete Manager

The Delete Manager always makes sure there is enough memory space on the hard disc for new recordings.

When the capacity of the hard disc is almost exhausted the old recordings are deleted.

Recordings which have been protected with a delete protection (see page 85) are not deleted by the Delete Manager. However, you can still delete these recordings manually.

To avoid data loss, we recommend copying important recordings to a rewritable DVD.

Delete the recordings from the Digital Recorder after copying.

Loewe is not liable for data loss from the Digital Recorder's hard disc.

## Record conflict

If you wish to programme a new recording which overlaps an timer recording already saved, the **Recording conflict** dialogue will open. Here you define whether only one or both recordings are to be made.

If you decide for both, you have to state which of the two programmes is to be recorded fully.

Other ways of solving this recording conflict:



**Green button:** Change the timer data of the individual programmes.



**END:** Reject new timer. The older timer entry is retained.

# Digital Recorder

## TV viewing with time shift

When an archive recording is taking place, you can watch the programme being recorded in time shift TV.

- ➡ Please also read the instructions on watching time-shifted television on page 66.
- ➡ Programmes with copy protection (e.g. Macrovision) cannot be watched with a time shift for legal reasons.

### Interrupt



Press **PAUSE** button.

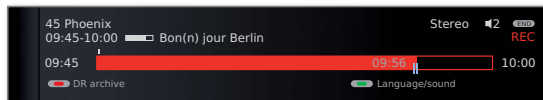

The TV image becomes a freeze frame and the DR status display appears.

At the top you will see the number and name of the station if EPG or teletext data are available, in addition to the start and end of the current programme and the title of the programme.

On the left hand side of the bar you can see the start time for time shift recording. The time at which the archive recording will finish is next to the bar. The bar shows how much of the programme has already been recorded. The time displayed inside the bar is the time at which the PAUSE button was pressed.

### Continue (time shift viewing)



Press **PLAY** button.

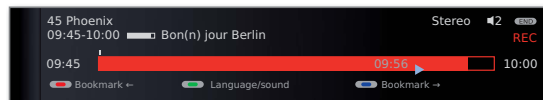

You can now watch the TV programme with a time shift from the time you pressed the **PAUSE** button. The Playback symbol ▶ appears in place of the Pause symbol II.

### Jump to automatically set bookmarks

With time-shift television, and with the status display showing, you can skip to automatically set bookmarks or to the start or end of the current recording. White bookmarks mark the beginnings and endings of broadcasts.



**Red button:** Jump back.

**Blue button:** Jump forwards.

### Switch to live picture



Press **STOP** button.

You see the station's live picture again.

### Jumping

You can jump during time shift viewing by briefly pressing the buttons ◀ ▶ in the jump distance set; this enables you to skip uninteresting sections quickly.



▶▶ Jump forwards.

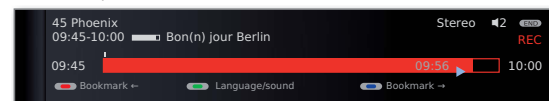

◀◀ Jump backwards.

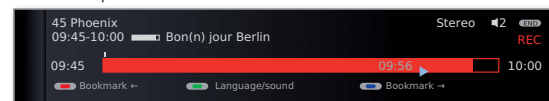

### Smart Jump

If Smart Jump is activated, the jump width is halved every time you change the jump direction. The jump width is doubled if you jump more than three times in the same direction (max. 8 min.).

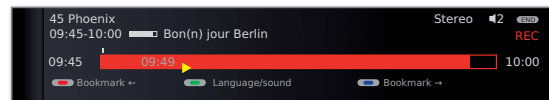

- ▶ : Jump width corresponds to the jump width preset in the **Digital Recorder** menu.
- ▶ : Jump width is less than preset in the **Digital Recorder** menu (e.g. after changing the jump direction).
- ▶ : Jump width is greater than preset in the **Digital Recorder** menu (e.g. after jumping three times in the same direction).



# Digital Recorder

## Fast forward and rewind

During time shift viewing you can fast forward and rewind at three different speeds. Sound is not audible during winding.

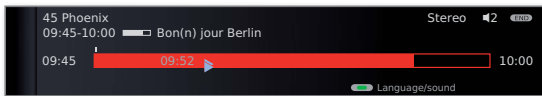
  Press  or  for a little longer.



By briefly pressing  or , the speed will increase until you switch back to the first speed.

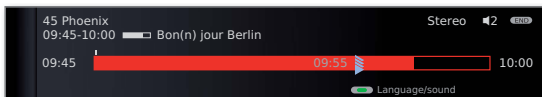

Playback begins automatically upon reaching the end of the recording. You are then about 10 seconds behind the live picture or when rewinding at the beginning of the time shift recording.

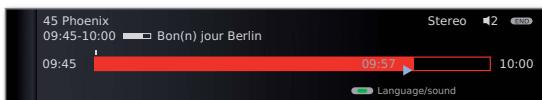



## Slow motion

If Pause is active (freeze picture) you can play at four slow-motion speeds. Sound is not audible during slow motion. When viewing HDTV slow motion backwards is not possible.

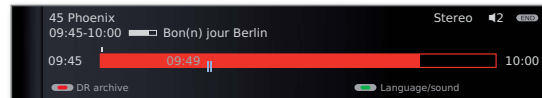

Press **PAUSE** button.



Press  or  briefly.

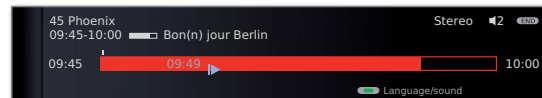

Increase speed:

Press  or  several times briefly.

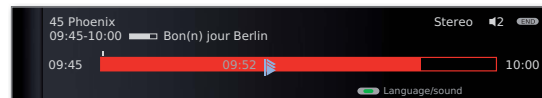

The speed increases every time you press the button until eventually switching back to the initial speed.

## Set bookmark

You can mark interesting scenes in sports reports for example to watch these again specially at a later viewing.

You can set bookmarks in time-shift TV or during live viewing.



Press **PLAY** button for a little longer: Set bookmark.

You will see a message on the screen. Every time the **PLAY** button is pressed down again a little longer, a new bookmark is set.

# Digital Recorder

## Archive playback



Call **DR archive**.

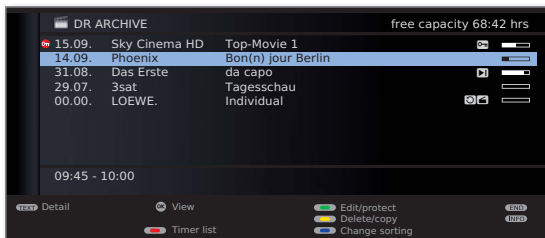

The remaining **free capacity** on the storage device is shown at the top right-hand corner.

► The free capacity indicated is an estimated value. The exact remaining capacity of the hard disc depends on the programmes to be recorded in future.

The progress bar shows you how much of the recording has been watched.

If other programme data is available from EPG or teletext these are shown below the archive list for the entry just flagged. Other information about the recording can be called with the **TEXT** button, if this is offered.



**Blue button:** Change sorting of the recordings.



**Green button:** Sort recordings by date.

**Yellow button:** Sort recordings alphabetically.

**Blue button:** Sort recordings by station.



Back to overview. The sorting last selected is retained.

### Explanations of the symbols in the DR archive

- Archive entry with active replay (page 80).
- Archive entry with set parental lock (page 84).
- Archive entry with set delete protection (page 85).
- Archive entry with manually set bookmarks (see right column).
- Coded archive entry.
- CI Plus coded archive entry.
- Archive entry is entered for transferring/copying in the timer overview (see page 81, **Copying recordings to a connected recorder**).
- Archive entry is entered for descrambling in the timer overview (see page 82, **Descramble scrambled recording**).

## Playing from the archive



▲ ▼ Select the recording.  
**OK** Start playback.

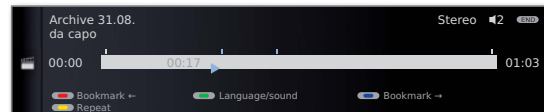

► The CA module with Smart Card must be plugged in when playing recordings which are still coded.

## Set bookmarks

While playing an archive recording, you can set bookmarks.



**PLAY button** (press for a little longer): Set bookmark.

You will see a screen message. The drive display is then faded in and you will see the set bookmark above the bar for the playback. You can set up to 15 bookmarks per recording.

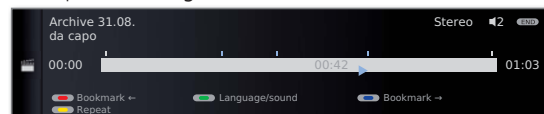

► Automatically set bookmarks are white. Manually set bookmarks are blue.

## Jumping to bookmarks



**INFO:** Show status display.



**Blue button:** Skip to next bookmark.

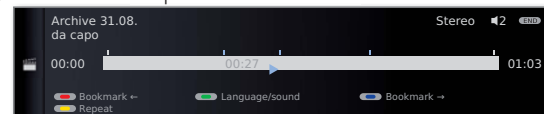

**Red button:** Skip to previous bookmark.

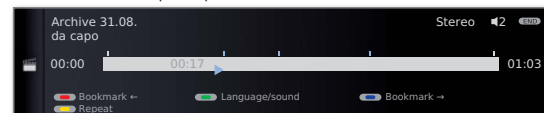

## Delete individual bookmarks



**Red or blue button:** Jump to the manually set bookmark to be deleted.

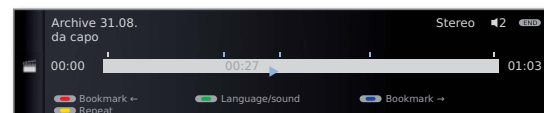

Press **PLAY button** for a little longer: Delete bookmark.

# Digital Recorder

⇒ When playing coded recordings, some of the following functions might only be possible with limitations.

## Jumping

By pressing **button** ◀◀ or ▶▶ you can skip through the broadcast.



▶▶ Jump forwards.

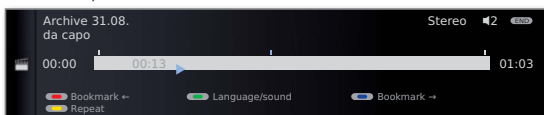

◀◀ Jump backwards.

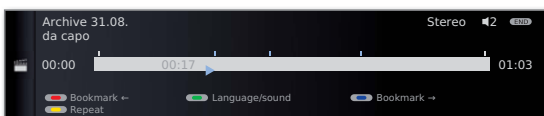

⇒ Setting the jump distance: see page 68.

## Smart Jump

Smart Jump allows you to search quickly for certain scenes of a recording. You will find more about this on page 76.

## Fast forward and rewind

During time shift viewing you can fast forward and rewind at three different speeds. Sound is not audible during winding. You will find more about this on page 77.

## Pause (freeze picture)



**PAUSE button:** Switch to freeze picture.

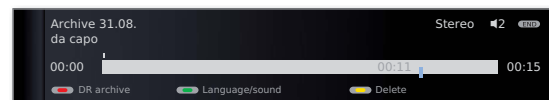

**PLAY button:** Continue playback.

## Slow motion

At an active pause (freeze frame) you can select from four slow motion speeds (for wind/rewind). There is no sound during slow motion replay.



**PAUSE button:** Change to freeze frame

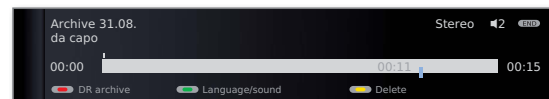

Press ▶▶ or ◀◀ briefly.

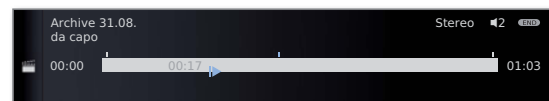

Increase speed:

Press button several times briefly.



The speed increases every time you press the button until eventually switching back to the initial speed.

# Digital Recorder

## Deleting parts of the recording

You can delete sections of a recording from the current position within the film to the beginning or to the ending.



**PAUSE button:** During archive playback press at the point from which, to the start or to the end, the archive recording is to be deleted.

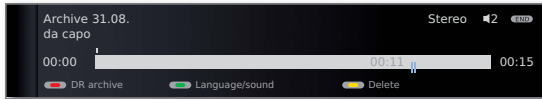

**Yellow button:** Call Delete.



**Red button:** Select **Delete from here to start**.

**Green button:** Select **Delete from here to end**.



**OK** Confirm delete.

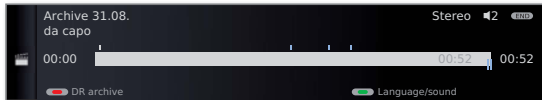

In this case, 11 min were deleted from the end of the broadcast so that the recording length is then just 52 min.

Or:



**Red or green button:** Abort delete.

## Deleting bookmarks

You can globally delete all manually set bookmarks.

Manually set bookmarks are blue, automatically set bookmarks are displayed in white.



**PAUSE button:** Change to freeze picture.

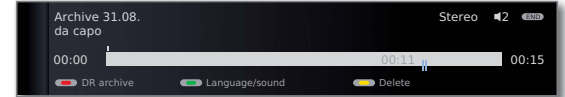

**Yellow button:** Call Delete.



**Blue button:** Delete manually set **bookmarks**.



**PLAY button:** Continue playback.



Automatically set bookmarks are not deleted. In addition, you have the option of deleting the bookmarks via **DR archive** → **Delete/copy** (see page 83).

## Repeat playback of recording

You can repeat recorded broadcasts and hence play them in an infinite loop.



**INFO:** Show status display.



**Yellow button:** Repeat film.

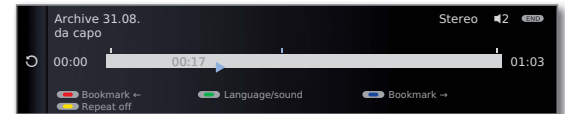

You will see a circular arrow on the left of the status display and in the archive after the name of the broadcast (see page 78). The function remains set for this broadcast even if the playback is interrupted.



**Yellow button:** Switch off repeat function again.



# Digital Recorder

## Copying recordings to a connected recorder



Call **DR archive**.



▼ ▲ Flag the recording to be copied.



**Yellow button:** Call **Delete/copy**.

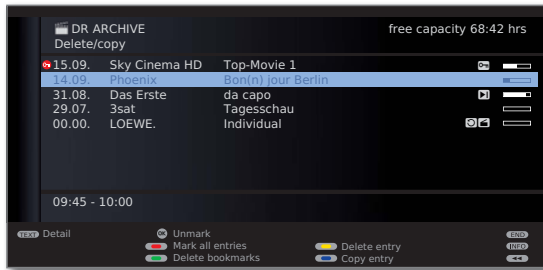

▼ ▲ Select others if necessary and **OK** mark entry.

Or:



**Red button:** Mark all entries.

⇒ Titles to be copied are displayed in blue.



**Blue button:** Call **Copy entry**.

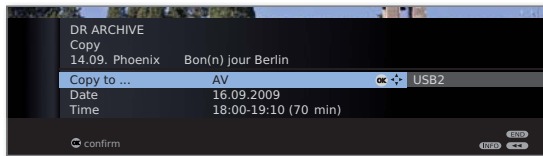

◀ ▶ Select **AV** in the copy menu.

Should be copied over later, change date and time.

**OK** Confirm.

You will see the archive again. In front of the date of the recording(s) to be copied, you will now see a red point for the programmed copying.

The status of copying assignments in progress/pending can be seen in the timer overview

- ⇒ You cannot watch a DVB station whilst copying. The TV set can, however, be switched off to the standby mode. It is best to copy at night when the TV is not in use.

## Copy recordings onto an external hard disc<sup>†</sup>

You can also copy programmes onto a further external hard disc, and archive them or make them available to other Loewe LCD TV sets.



Call **DR archive**.

Select titles to be copied as described in the left column.



**Blue button:** Call **Copy entry**.

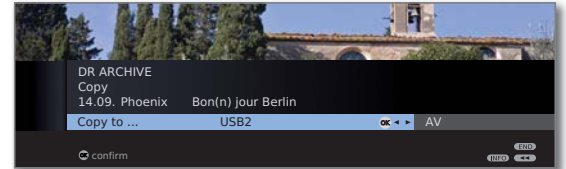

◀ ▶ Select **USBx** in the Copy menu.  
**OK** Start copying.

- ⇒ Copying to an external hard disc takes place in the background and at a significantly higher speed. Contrary to copying recordings to a connected recorder (see left column), there are no selection restrictions here regarding the stations. You see a screen message, when copying has finished.

The status of copying assignments in progress can be seen in the timer overview.

- ⇒ The TV set must **not** be switched off with the mains switch during the copying!

## Delete programmed descrambling

You can delete a programmed descrambling of scrambled recordings at any time.

- ⇒ DR archive is displayed.



▼ ▲ Mark the desired programme (red dot with key symbol).



**Yellow button:** Call **Delete/descramble**.



**Blue button:** **Cancel descrambling**.

The red dot with key symbol and the entry in the timer list are deleted.

<sup>†</sup> Only when a USB hub is being used.

# Digital Recorder

## Descramble scrambled recording

You can start descrambling scrambled recordings manually at any time<sup>(1)</sup>. The CA module with the smart card must be inserted at the time of descrambling. Descrambling should be done as soon as possible because the probability that the code may become invalid increases with the time between recording and descrambling.

Proceed similarly to copying from the archive:

- ➡ DR archive is displayed.
- ▼ ▲ Mark recording to be descrambled.
- ➡ Scrambled recordings are marked by  in front of the bar.



**Yellow button:** Call **Delete/copy**.



**Blue button:** Call **Descramble entry**.

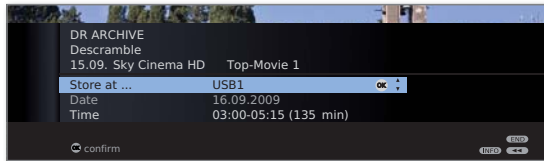

- ◀ ▶ Select **USBx**.  
Determine date and time of the descrambling.
- OK** Confirm.

You see the DR archive again. You will see a red dot with key symbol for the programmed descrambling in front of the date.

- ➡ No other DVB station can be watched during descrambling. But the TV set can be switched off to standby mode. It is best to descramble at night when the TV is not in use.
- ➡ You will find the recording descrambled in the DR archive after successful descrambling (without a  before the bar).
- ➡ The time and date of the descrambling can be changed subsequently in the timer list (see page 72).

## Deleting recordings from the archive

- ➡ DR archive is displayed.
- ▼ ▲ Flag the recording to be deleted.



**Yellow button:** Call **Delete/copy**.

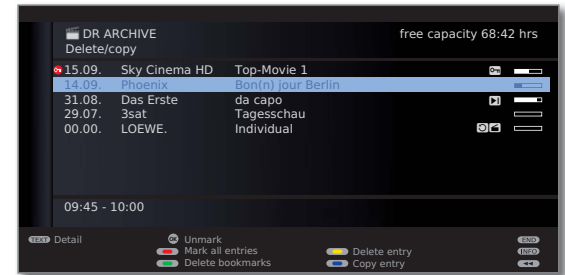

- ▼ ▲ Select others if necessary and **OK** confirm.



- Red button:** Mark all entries.  
➡ Titles to be deleted are displayed in blue.



**Yellow button:** Call **Delete entry**.



- OK** Confirm delete.  
The recording(s) is/are deleted.  
The DR archive is displayed again.

<sup>(1)</sup> Please also read the instructions on pages 87 and 88 concerning the handling of encoded programmes.

# Digital Recorder

## Delete bookmarks



- DR archive is displayed.
- Select the recording for which you want to delete the bookmarks.
- Recordings with manually set bookmarks are flagged with in front of the bar.



**Yellow button:** Call **delete/copy**.

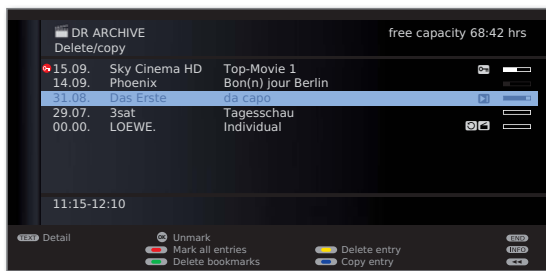

- Select others if necessary and **OK** confirm.

Or:



**Red button:** Mark all entries.

- The selected titles are displayed in blue.



**Green button:** **Delete bookmark.**

All manually set bookmarks from the marked entries are deleted. Automatically set bookmarks are not deleted.

## Changing the title of an archive



- DR archive is displayed.
- Select the title to be changed.



**Green button:** Call **Edit/protect**.

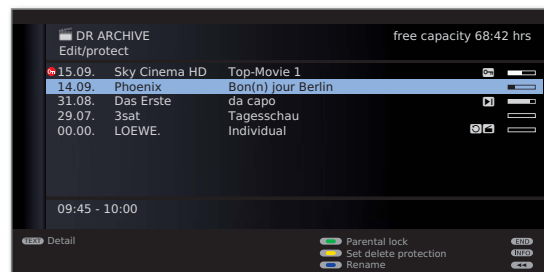

Press the **blue button** for **Rename**.

Underneath the first letter of the title, you will see a line which indicates the current input position for the letter.



- Input position to the right.
- Input position to the left.



Input the characters one after another (if entering using the number buttons on the remote control, use it as if it were a telephone keypad; see page 106 for the exact assignment of the buttons).



**Yellow button:** Delete character to the left of the cursor.



**Green button:** Switch between capital letters and small letters.



**OK** Conclude the entry.  
This saves the change permanently.

# Digital Recorder

## Locking/unlocking a movie (Parental lock)

You can lock movies that your children are not permitted to view, for instance. Viewing is then only possible if the PIN number has been entered beforehand.

➡ DR archive is displayed.



**Green button:** Call **Edit/protect**.



▼ ▲ Mark the title that is to be locked.

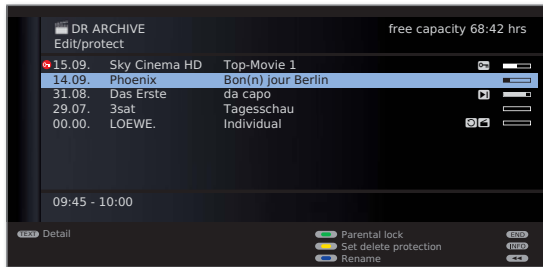

**Green button:** Call **Parental lock**.

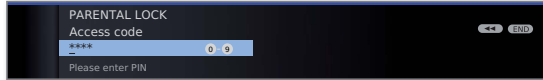

Enter your access code with the **numeric buttons** of the remote control. If you define an access code for the first time, remember it well. Confirm the new access code with **OK**. The DR archive opens again.



**Green button:** **Lock movie**.



▲ ▼ Select others if necessary.



**Green button:** **Lock movie** or **Unlock movie** again.

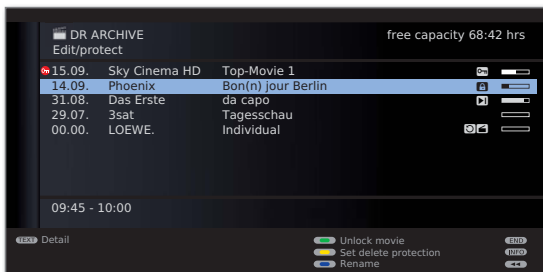

A lock symbol  will be displayed before the bar in the case of locked films.

## Viewing a locked movie



Call **DR archive**.

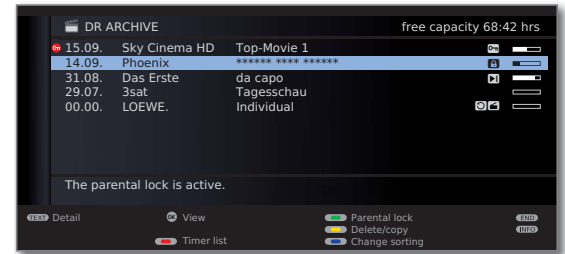

▼ ▲ Mark locked film,  
**OK View** film.

➡ The covers of locked films cannot be read. The detailed information for the recording cannot be called up. The entry receives the symbol  at the end of the line.

The system requests you to enter your access code (PIN). After entering the access code the playback of the movie starts.

# Digital Recorder

## Setting/cancelling delete protection

You can provide films with a delete protection to prevent an automatic deletion by the delete manager (see page 75).

DR archive is displayed.



**Green button: Call Edit/protect.**



▼ ▲ Select the title for which you want to set/cancel a delete protection.



**Yellow button: Set/Cancel delete protection.**



▼ ▲ Select others if necessary.



**Yellow button: Set/Cancel delete protection.**

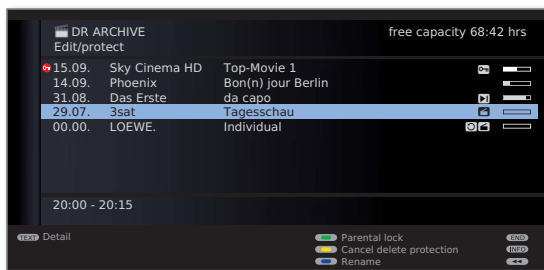

The symbol  appears in front of the bar when the delete protection is activated.

# Digital Recorder

## Formatting the hard disc

Format USB hard discs that you wish to use with the TV set before the first use via the **TV menu** → **Settings** → **Miscellaneous** → **Format external hard disc**.

A formatting might also provide a remedy in the event of problems when using the USB disk.

Additionally, you can re-format the hard disc in order to quickly and easily delete all the data stored on it.

### Attention!

Formatting of the hard disc deletes **all** the data saved on it!

MENU

Call **TV menu**.



- ◀ ▶ Select **Settings**,  
▼ switch to the menu line below.
- ◀ ▶ Select **Miscellaneous**,  
▼ switch to the menu line below.
- ◀ ▶ Select **Format external hard disc**,  
**OK** activate.

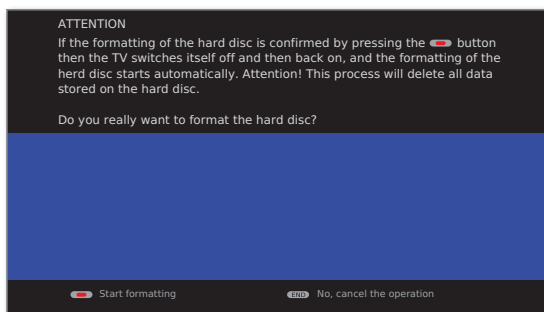

## Further information

### Automatic time control

Your TV set can use the automatic time control for recording a programme.

The **automatic time control** assumes the corresponding monitoring of the start and end time for **DVB stations**. The recording is started at the beginning of the broadcast and switched off at the end, even if the start and/or end time have been changed by the programme provider. Broadcast interruptions are also taken into account. However, the automatic time control is not supported by all stations.



**Red button: Start formatting.**

➡ After the formatting, the TV set must be re-started.

Or:

END

**END:** Cancel the operation.

## DVB Common Interface standard (CI)

If a programme has been recorded coded, the decoding process is carried out automatically the next night in the standby mode (when timer data settings do not differ). Please note that the TV set may not be switched off at the mains overnight and that the CA module with SmartCard must be inserted in the CI slot of the TV set.

If the recording is not decoded fairly soon after decoding, it may not be possible to decode it at all. The longer the time between recording and decoding, the greater the probability that the code is no longer valid.

- ➡ Scrambled hard disc recordings appear in the timer list until they are descrambled (page 72).
- ➡ You can also start decoding manually (see page 82).
- ➡ Your programme provider may not support later (time offset) descrambling.
- ➡ The playback of encrypted programmes is strongly dependent on which CA module is used. The playback of encrypted recordings may sometimes not be possible, or only to a limited extent.  
Hint: When possible, record unencrypted programmes or unencrypt them as soon as possible.
- ➡ Selection possibilities in the CA module menu and performance capability of your CA module depend on the type of module used and the installed software. Consult the manufacturer of the module if you have any questions.

## DVB Common Interface Plus standard (CI Plus)

CI Plus is an advanced development of the DVB Common Interface Standard. CI Plus slots are in principle downward compatible to the previous CI standard, i.e. CA modules and Smart Cards according to the past CI standard can continue to be used in CI Plus slots, as far as the programme provider permits this.

The regulations of the past standards (see page 87) likewise apply to CI Plus. There are however further additional regulations.

Programme providers, who use the CI Plus standard, can assign different rights for their broadcast programmes. For instance, the programme provider can restrict or completely prevent recording or later watching of an encoded programme. If there are such regulations, these also apply to time-shifted watching of television programmes.

A screen message informs you of this fact, if you would like to record such a programme. Recording is carried out in such a case (an appropriate entry is displayed in the DR archive), later watching of the programme is however not possible at all or only for a limited period (e.g. 10 days). A possible time limitation of the playback will also appear in the corresponding entry in the DR archive.

The provider can also prohibit later decoding of a recorded encoded programme.

► All restrictions mentioned here are the responsibilities of the broadcaster. The TV simply values the broadcaster set signalling as neutral.

Furthermore, the programme provider can prevent external copying of protected programmes, e.g. on a DVD recorder (also after possible decoding).

It could be necessary to enter the parental protection PIN of the CA module when programming the data, if you want to record a CI Plus protected programme, which has been protected against viewing by minors. The secret number of the TV set is required for watching the programme later.

The appearance of the CA module menu of CI Plus can deviate from the normal appearance of the TV menu.

### Software update for CI Plus capable CA modules

Every now and then, there will be new system software for your CA module software. There are two software update types.

Recommended update:

Information on an available update is displayed. You can either run this or cancel the procedure. If you do not install the update, the information will reappear in regular intervals until the update has been installed.

Forced update:

Information on an available update is displayed. The module does not decode any more until the update has been successfully implemented.

## Troubleshooting (CA module)

The following information can help, if problems should occur when running a CA module:

Switch the TV set off to the standby mode. Remove the CA module from the TV set. Switch the TV set off completely. Wait a few seconds. Reinsert the CA module. Switch the TV set on again.

If errors continue to occur, make a note of the displayed two-digit error code (only for CI Plus capable CA modules). Contact your technical customer service. You will find the service addresses on page 126.



# External devices

## Connections menu

Settings for the connection of external appliances are made in this menu.

### Calling the connections menu



**MENU:** Call TV menu.



- ◀ ▶ Select **Connections**,
- ▼ go to the menu line below.

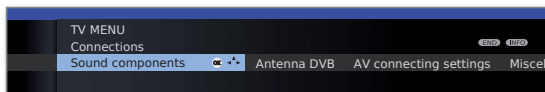

- ◀ ▶ Select the desired setting.

### Explanations of setting possibilities in the Connections menu:

Sound components	The sound components wizard helps you to configure the components which are used to reproduce the TV sound. You will find a description of the sound components wizard on page 96.
Antenna DVB	Here you can set the parameters of the DVB-T and the DVB-S <sup>(1)</sup> antenna with the antenna wizard. The setting options of the DVB antennas are described in the first time operation routine (from page 21).
AV connecting settings	See right column for explanations.
Miscellaneous	See page 90 for explanations.

## AV connection settings

In the AV connection settings menu the parameters for the AV and AVS connection sockets can be adapted.

### Calling AV connection settings



**MENU:** Call TV menu.



- ◀ ▶ Select **Connections**,
- ▼ go to the menu line below.

- ◀ ▶ Select **AV connecting settings**,
- ▼ go to the menu line below.

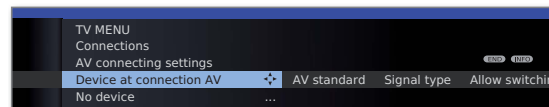

- ◀ ▶ Select the desired setting.

### Explanations of setting possibilities in the AV connecting settings menu:

Device at connection AV	Indicate here whether a set and, if yes, which one is connected to the AV socket.
AV standard	You set the AV standard of the connected appliance to AV or AVS here. Normally you leave the setting on <b>Automatic</b> . If the standard of the connected appliance is not detected automatically, select the right standard. Ask your dealer or consult the operating manual of the connected appliance if necessary.
Signal type	You set the signal type of the device connected to AV or AVS here. Normally, you should leave the setting at <b>Automatic</b> ; otherwise select a suitable signal type. You can find out more from your dealer.
Allow switching voltage	If this function is activated and you switch an AV device (not at AVS) that outputs a switching voltage to playback, its picture and sound will be played immediately on all TV station slots.

<sup>(1)</sup> Equipment and upgrade options, see page 115.

# External devices

## Connections – Miscellaneous

Various settings (e.g. Digital Link, Decoder etc.) in connection with external appliances are made in this menu.

### Calling up other settings for connections



**MENU:** Call TV menu.



◀ ▶ Select **Connections**,  
▼ go to the menu line below.

◀ ▶ Select **Miscellaneous**,  
▼ go to the menu line below.

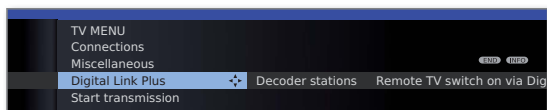

◀ ▶ Select the desired setting.

### Explanations of setting possibilities in the Miscellaneous menu:

**Digital Link Plus** With this function the station data of the TV set can be transmitted to a connected Digital Link Plus capable recorder. Only the station data of analogue TV stations can be transmitted.

**Decoder stations** Here you can identify analogue stations with encoded content as decoder stations and set the mode of the sound encoding of encoded audio signals, so that these are automatically decoded by a decoder connected to AV. Menu item only available if a **Decoder** has been selected as **Device at connection AV** (see page 89).

**Remote TV switch on via Digital Link** Here you can select whether the TV set is to switch on automatically from Standby mode, if a tape / disc is to be played or a screen menu displayed from **Digital Link HD** or **Digital Link Plus**-enabled devices which are connected to HDMI or AV inputs (see also page 91 and 93).

**Gaming mode** Here you can set a faster display of your activities on the screen for various inputs of the TV set, e.g. for games consoles (see right hand column).

## Gaming mode

For the inputs of your TV set on which game consoles, PC applications or even Karaoke machines are operated, we recommend you to activate the Gaming mode. Your activities are then displayed quicker on the screen by reducing the complex picture improving techniques. This mode can be set separately for every input of your TV set.



**MENU:** Call TV menu.



◀ ▶ Select **Connections**,  
▼ go to the menu line below.

◀ ▶ Select **Miscellaneous**,  
▼ go to the menu line below.

◀ ▶ Select **Gaming mode**,  
OK call.

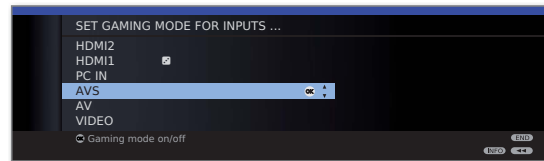

▲ ▼ Select socket,  
OK **Gaming mode** for selected socket **on/off**.

You can recognise AV connections with set Gaming mode by the symbol  after the connection name.

### Switching Games mode on/off via the status display

You can also switch the Games mode for the selected AV input on and off via the status display.



Call **AV selection**.



▲ ▼ Select desired connection,  
OK switch over.



**INFO:** Call up status display (if this is no longer shown after switching to the AV connection).



**Green button:** Switch **Gaming mode** for selected connected **on** or **off** according to status.

# External devices

## Devices to the connections AV/AVS

An additional appliance such as a DVD player, VCR/DVD recorder etc. can be connected to the TV set at the Euro-AV socket **AV** (see page 11).

The AV input **AVS** (see page 11) offers the possibility of connecting a digital camera or a Camcorder for example.

The AV sockets can process different signal types. Which signal type your accessory device provides can be found in the operating manual of the appropriate device.

Owing to the large number of AV devices available on the market, we can only mention a few examples for the connection of accessory equipment to the AV sockets here.

### Remote TV switch on via Digital Link

You can select whether the TV set is to switch on automatically from Standby mode if a disc is played or a screen menu displayed on a **Digital Link Plus**-enabled device connected to **AV**.

You can find the settings in the **TV Menu** under **Connections** → **Other** → **Remote TV switch on via Digital Link** (see also page 90).

### Connecting a DVD player to the TV set

➤ A **DVD player** has been selected in the **TV Menu** under **Connections** → **AV connecting settings** → **Device at connection AV** (see also page 89).

Switch off all equipment before connecting.

Connect the Euro-AV output of the DVD player to the **AV** socket of the TV set.

Use a fully equipped Euro-AV cable (available from your dealer) for this.

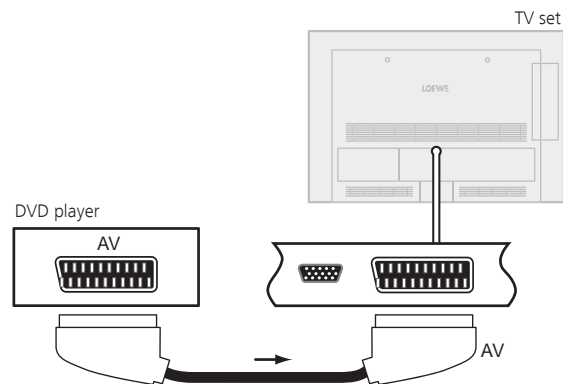

Connection example of a DVD player

### Playback from AV device

If the device at AV supports the **Digital Link Plus** functionality or if in the **TV menu** → **Connections** → **AV connecting settings** → **Allow switching voltage** → **yes**, the TV set will automatically switch to the corresponding AV input after starting the replay at the AV device.

The AV input can also be called manually, however.



Call **AV selection**.



▲ ▼ Select **AV**,  
**OK** switch over.

Start playback on the connected device.

# External devices

english

## Connecting a DVD recorder to the TV set

➔ A **DVD recorder** has been selected in the **TV Menu** under **Connections** → **AV connecting settings** → **Device at connection AV** (see also page 89).

Switch off all equipment before connecting.

Connect the Euro-AV output of the DVD recorder to the **AV** socket of the TV set.

Use a fully equipped Euro-AV cable (available from your dealer) for this.

If you want to receive and record analogue stations with the receiver (tuner) built into the recorder, the recorder must be looped into the aerial cable.

Connect the DVD recorder as shown in the connection example below.

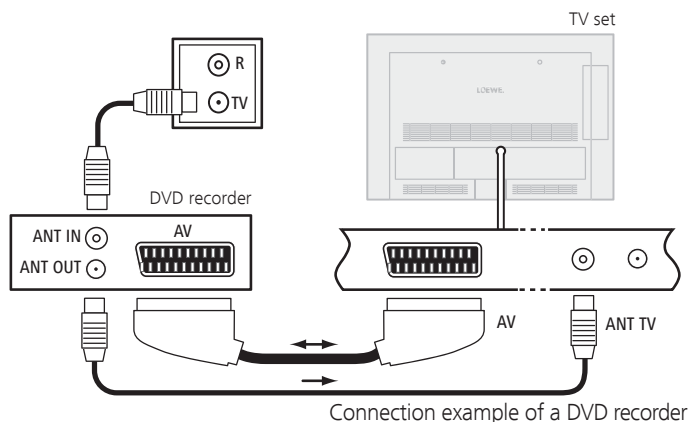

➔ If you want to record DVB stations with an external recorder, the internal receiver of the TV set must be used (see **Timer recording with external devices** on page 101).

## Playback from AV device



Call **AV** selection.



▲ ▼ Select **AV**,  
**OK** switch over.

Start playback on the connected device.

## Connecting Camcorder/camera

Switch off all equipment before connecting.

Connect the AV output of the camcorder to the sound input sockets **AUDIO IN L** (white) and **AUDIO IN R** (red) and the **AVS** connection of the side AV sockets of the TV set.

Use the AV cable enclosed with the camcorder for this.

Some camcorders only supply an FBAS signal instead of an S-Video signal at the AV output. In this case use the **VIDEO IN** input (yellow).

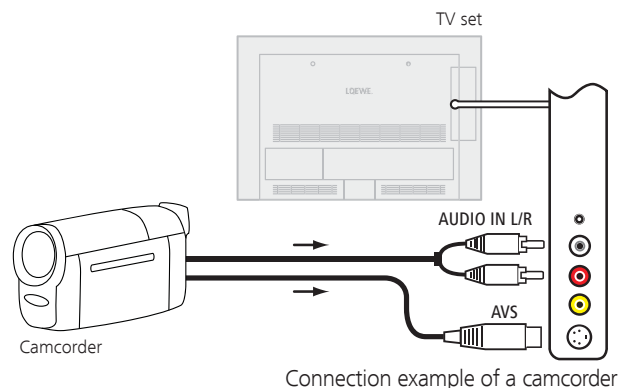

## Playback from AV device



Call **AV** selection.



▲ ▼ Select **AVS**,  
**OK** switch over.

Start playback on the connected device.

# External devices

## Devices to the HDMI connections

The HDMI connections (High Definition Multimedia Interface) allow the transmission of digital video and audio signals from a player (e.g. DVD player, DVD recorder, Blu-ray player, game console or Set-Top-Box) via a single cable.

The digital video and audio data are transmitted without data compression digitally and therefore lose none of their quality.

A maximum of five devices can be connected in cascade to every HDMI socket. The devices are arranged in the AV menu and in the station list below the appropriate HDMI socket. If the respective device sends its own device name, this appears in place of the connection name.

Your TV set can show 24p films, which are output from a connected HDMI player (e.g. Loewe BluTech Vision Interactive) optimally (see glossary, page 119).

Digital video signals from a DVI player can be also be reproduced by the HDMI connection using a DVI/HDMI adapter cable. The sound must be piped in additionally. However, the sound must then be supplied additionally. HDMI and DVI both use the same copy protection method HDCP.

### Connecting the device

Switch off all equipment before connecting.

Connect the device by an HDMI cable (Type A, 19-pole) to one of the **HDMI** sockets of the TV set.

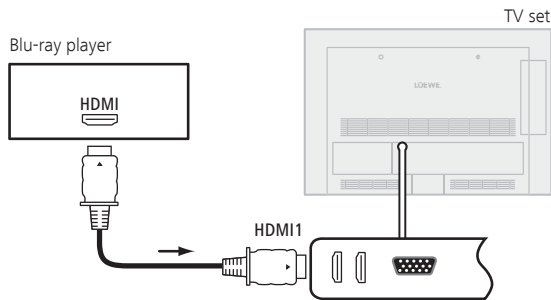

Connection example of an HDMI device (e.g. Blu-ray player)

If a DVI/HDMI adapter cable is used, the associated sound can be fed via the sound input socket **AUDIO IN** (analogue).

### Playback from the device

If the device at **HDMI** supports the **Digital Link HD** functionality, the TV set will automatically switch to the corresponding HDMI input after starting the replay at the HDMI device.

The HDMI input can also be called up manually:



Call **AV selection**.



▲ ▼ Select **HDMI** socket.

With **Digital Link HD**-capable devices the device name may possibly appear in place of the connection name.

**OK** Switch over.

Start playback on the connected HDMI device. The best possible format for the picture is detected and set automatically.

### Remote TV switch on via Digital Link

You can select whether the TV set is to switch on automatically from Standby mode if a disc is played or a screen menu displayed on a **Digital Link HD**-enabled device connected to an **HDMI** input.

You can find the settings in the **TV Menu** under **Connections** → **Other** → **Remote TV switch on via Digital Link** (see also page 90).

# External devices

## Adjust Geometry (only possible with certain signals)

This allows you to shift the picture (horizontally and vertically) so that it fills the entire screen.

➔ When connecting a PC to an **HDMI** socket of the TV set, set the output signal at your PC beforehand so that it corresponds to one of the signals in the table on page 110.

MENU

**MENU:** Call TV menu.



- ◀ ▶ Select **Picture**,  
▼ go to the menu line below.
- ◀ ▶ Select **more ...**,  
**OK** call.
- ◀ ▶ Select **PC IN display**,  
▼ go to the menu line below.

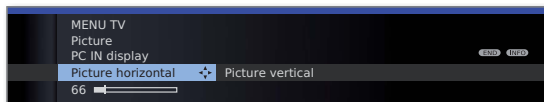

- ◀ ▶ Select the desired setting,  
▼ go to the menu line below.
- ◀ ▶ Make settings.

## Digital Link HD

### Digital Link HD (HDMI CEC)

The **Digital Link HD** (HDMI CEC) system operation allows Loewe television sets to transmit the remote control signals via the HDMI connection of a TV set to compatible HDMI devices, such as e.g. Loewe AudioVision. You can therefore set up a concealed CEC capable HDMI device.

### Concealed installation of HDMI devices

For this, first assign the HDMI CEC function with Code **22** to the required device button (**REC**, **DVD** or **AUDIO**) as described on page 102.

Now assign the **Digital Link HD** function to the used HDMI device.

### Assign HDMI device

➔ The CEC capable HDMI device is connected to one of the HDMI sockets of the TV set and switched on.

REC DVD AUDIO Press required button for 5 seconds.

A selection menu appears on the TV set.

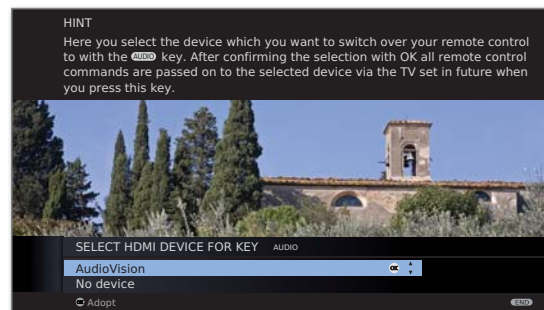

- ▲ ▼ Select required device from the list.  
**OK** Adopt.

From now on, the commands of the remote control are communicated from the TV set to the HDMI device, if the corresponding device button (**REC**, **DVD** or **AUDIO**) has been pressed previously.

# External devices

## Devices to the PC IN connection

You can connect a PC to the **PC IN** socket for example and thus use the TV screen as a monitor.

- ➔ When connecting a PCs or accessory device to the **PC IN** socket of the TV set, set the output signal on your PC first so that it matches one of the signals in the table on page 110.

### Connecting the device

Switch off all equipment before connecting.

Connect the device to the TV set's **PC IN** socket with a VGA cable.

Connect the analogue audio signal of the PC to the **AUDIO IN** jack on the TV set with a stereo cable.

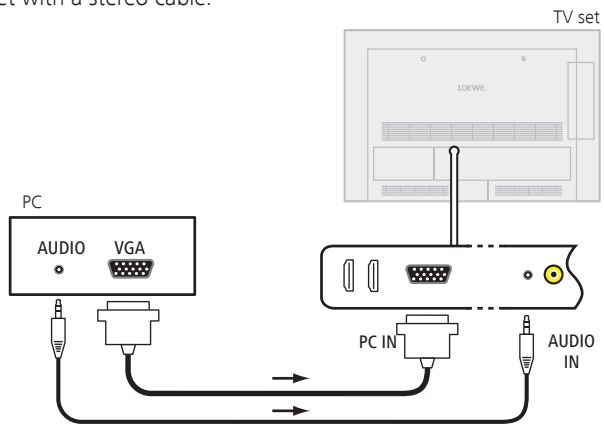

Connection example of a PC

If your PC has an HDMI interface, you can also connect the PC via the HDMI socket to your TV set (see page 93).

Depending on the version of the HDMI connection on the PC, the audio signal is also transmitted via the HDMI connection.

If this is not the case, connect the analogue sound as described above. See the appropriate operating manual for further information about the version of the HDMI interface on your PC.

## Playback from the device



Call **AV selection**.



▲ ▼ Select **PC IN** socket,  
**OK** switch over.

## PC picture adjustment (only possible with certain signals)

In this menu you can set the position (vertical, horizontal) and the phase length of your PC.



**MENU:** Call **TV menu**.



◀ ▶ Select **Picture**,  
▼ go to the menu line below.

◀ ▶ Select **more ...**,  
**OK** call.

◀ ▶ Select **PC IN display**,  
▼ go to the menu line below.

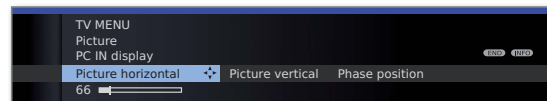

◀ ▶ Select the desired setting,  
▼ go to the menu line below.

◀ ▶ Make settings.

# External devices

## Sound components wizard

The sound component wizard helps you to configure the components that are used to reproduce the TV sound. You can configure the sound playback to come from the TV loudspeakers, active loudspeakers, TV loudspeakers and subwoofer as well as from analogue and digital HiFi/AV amplifiers.

### Sound reproduction in TV sets without an integrated digital multi-channel audio decoder

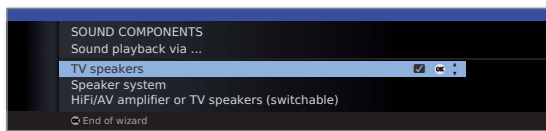

**TV speakers** Sound reproduction via the built-in TV speakers (factory setting).

**Speaker system** Set the sound playback to come from the TV loudspeakers and a connected subwoofer or from active stereo loudspeakers (see page 97).

**HiFi/AV-amplifier or TV speakers (switchable)** Sound reproduction optionally via an external analogue or digital audio amplifier (see page 98) or via the built-in TV loudspeakers. The sound reproduction can be changed using the **button** .



# External devices

## Connecting speaker system

If you wish to use active loudspeakers or an active subwoofer, you can connect them to the **AUDIO OUT L/R** sockets of the TV set.

### Using active loudspeakers

Switch off all equipment before connecting.

Plug the active loudspeakers into the **AUDIO OUT L/R** sockets of the TV set.

➡ The sound component wizard is open.

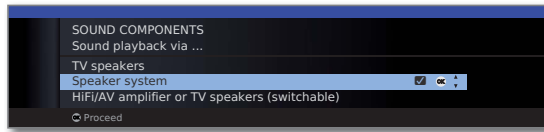

▼ ▲ Select **Speaker system**,  
OK confirm.

Connect front speakers:

◀ ▶ Select **External speakers**,  
OK confirm.

The connections on the adapter cable are preamplifier outputs. Therefore, only active speakers may be connected.

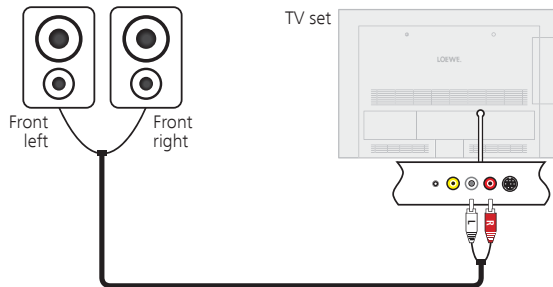

Connection of active speakers to the TV set

### Using TV loudspeakers and active subwoofer

Switch off all equipment before connecting.

Plug the active subwoofer into one of the **AUDIO OUT L/R** sockets of the TV set.

➡ The sound component wizard is open.

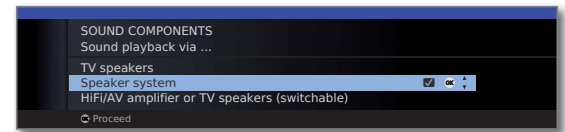

▼ ▲ Select **Speaker system**,  
OK confirm.

Connect front speakers:

◀ ▶ Select **TV speakers**,  
OK confirm.

Connect subwoofer:

◀ ▶ Select **yes**,  
OK confirm.

Adjust subwoofer level:

◀ ▶ Set the subwoofer level as desired.  
OK confirm.

Specify crossover frequency:

◀ ▶ Set the highest limit frequency of the subwoofer.  
OK confirm.

Subwoofer phase:

Use **P+/P-** to select a channel with music or start a music playback from an external player (e.g. DVD player, Blu-ray player).

◀ ▶ Test both values (0° and 180°) and choose the one that enables you to hear the bass playback more clearly.

OK Confirm setting and close wizard.

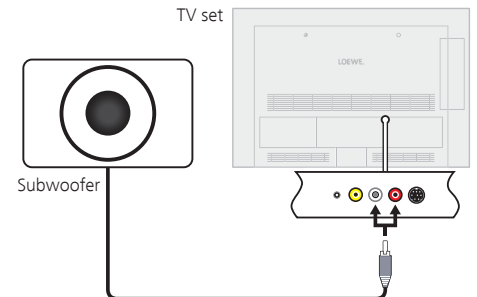

Connection of a subwoofer to the TV set

# External devices

## Connecting audio amplifiers

The sound components wizard permits configuration of different audio amplifiers (stereo amplifiers, surround amplifiers, analogue or digital) with different digital audio formats (Dolby Digital, dts, MPEG, and stereo/PCM). See the operating manual of the audio amplifier for more information.



**MENU:** Call TV menu.



- ◀ ▶ Select **Connections**,
- ▼ go to the menu line below.

- ◀ ▶ Select **Sound components**.
- OK** calls the sound components wizard

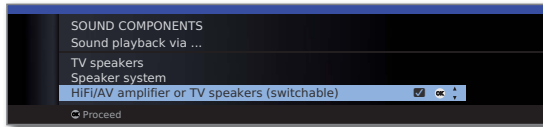

- ▼ ▲ Mark **HiFi/AV amplifier or TV speakers (switchable)**.
- OK Proceed.**

- ◀ ▶ Select whether the sound is to be transmitted digitally or analogue to the the amplifier. Continue, depending on the amplifier, see right column.

### Explanations of the setting possibilities:

**HiFi/AV amplifier or TV speakers (switchable)** Select setting if an amplifier is connected and your TV set has TV speakers connected. In the sound mode selection the audio reproduction can then be switched between the amplifier and the TV speakers.

**Sound formats** Specify sound formats which can be decoded with the digital amplifier (see operating manual of the used amplifier).

**Type of amplifier** Select either stereo or surround amplifier.

## Connecting digital audio amplifiers

Continuation of the left column above ...

For digital audio transmission: Select **yes**.

Connect the digital audio output of the TV set **AUDIO DIGITAL OUT** with the digital audio input of the amplifier via a cinch cable:

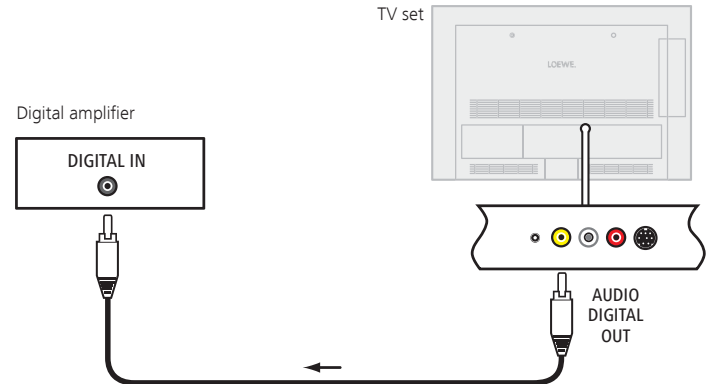

Sound formats, amplifier type and other settings, see explanations of the setting possibilities (left hand column).

## Connecting analogue audio amplifiers

Continuation of the left column above ...

For digital audio transmission: Select **no**.

Use a stereo cinch cable to connect the analogue audio output **AUDIO OUT L/R** with the analogue audio input of the amplifier:

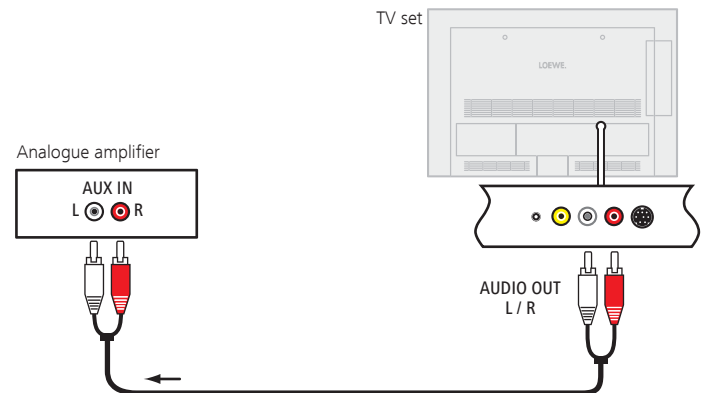

For selecting the amplifier type and making other settings, see explanations of the setting possibilities (left hand column).

# External devices

## The direct way to record

You can programme timer recordings on the TV set for USB Recording or for recorders that are otherwise connected. The recording wizard is integrated at several places for programming a recording. You will find further information on recording with the digital recorder from page 70 onwards.

### Programming a timer recording with the EPG

➡ You are in EPG mode; if not, press the **EPG button**.



▼ ▲ Mark the desired broadcast.



**RECORD button:** Call **Timer data** (see right hand column).

### Programming a timer recording via teletext

➡ You are using the teletext mode; or if not, press the **TEXT button**.



**RECORD button:** Call the programme pages of the current station.

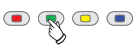

**Green button:** Go to the appropriate page.



▼ ▲ Select desired broadcast,  
**OK** calls **Timer data** (see right hand column).

### Entering the Timer data

After selecting the station you wish to record, timer data will be displayed.

The setting options for the timer data differ depending on the recorder selection, whether an analogue or DVB station is to be recorded or via which route (EPG, Teletext) the recording has been programmed.

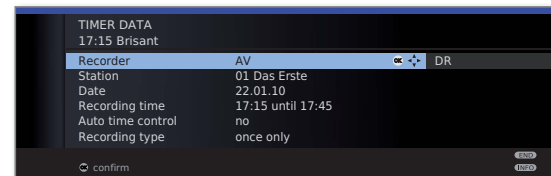

▲ ▼ ◀ ▶ Change **Timer data** if required or, **OK** confirm.

### Setting possibilities in the Timer data menu:

Recorder Selection of the recorder used (**AV**, **DR**<sup>(3)</sup>).

Date Day of recording.

Recording time Time of recording.

VPS Use VPS data for analogue stations, **yes/no**<sup>(1)</sup>.

Descrambled If recording encoded stations<sup>(3)</sup> you can define here whether recording the station is to be encoded during the recording, if possible.

Decoding If you choose the setting **yes**, the programme will be overnight automatically decrypted at 02.00 the following day<sup>(3)</sup> (CA module must be plugged in).

Programme provider PIN Here you can indicate the PIN of the programme provider for your **CI plus** CA module in order to enable decrypted recording<sup>(3)</sup> of a station protected with parental control.

Auto time control Use automatic time control, **yes/no**<sup>(2)</sup>.  
The recording is performed **precisely** at the time, even if the beginning/end time of the programme provider has changed.

Recording type Select **once only**, **Mo-Fri**, **daily**, **weekly** or **Serial**<sup>(2,3)</sup>.

Record Select whether broadcast subtitles are to be recorded<sup>(3)</sup>.  
subtitles

<sup>(1)</sup> only available with some analogue stations.

<sup>(2)</sup> only available when recording via EPG.





<sup>(3)</sup> Only if an external hard disk is connected (USB recording), see page 70 onwards.

# External devices





## Programming the timer with the timer overview

All programmed recordings, marked programmes and copy orders<sup>(1)</sup> are listed in the timer overview. You can also programme new recordings, mark other programmes and copy orders<sup>(1)</sup> pre-recorded programmes from the DR archive to an external recorder with the timer overview.

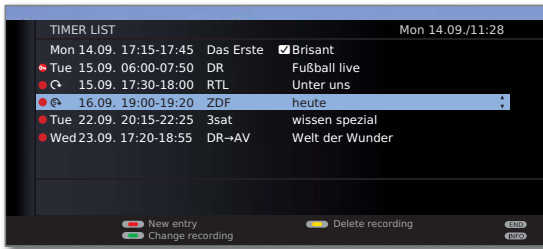



 Call **DR-archive**<sup>(1)</sup>.

    **Red button:** Call **Timer list**.



-     **Red button:** New entry (see right hand column).  
**Green button:** Change recording.  
**Yellow button:** Delete recording.  
**Blue button:** Delete memo.

## Explanation of the symbols in the timer list:

-  Record
-  Repeated recording (daily, weekly or Mon-Fri)
-  Serial recording<sup>(1)</sup>
-  Decoding order (later decoding of an encrypted recorded programme<sup>(1)</sup>)
-  Marked programme (see page 45)

<sup>(1)</sup> Only if an external hard disc is connected (USB Recording).

## New entry: Programme timer recording manually

⇒ Timer list is opened.

    **Red button:** Call **New timer entry**.

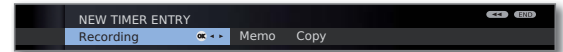

◀ ▶ Select **Recording**,  
**OK** call.

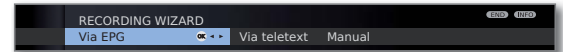

◀ ▶ Select **Manual**.

For programming a timer recording **Via EPG** or **Via Teletext** see page 99.

**OK** Call **Station selection**.

◀ ▶ ▲ ▼ Select station.

**OK** Call **Timer data**.

Entry of the timer data see page 99.

After confirming the timer data the new recording is transferred to the timer overview.

## New entry: Memorize programme using the timer overview

⇒ Timer list is opened.

    **Red button:** Call **New timer entry**.

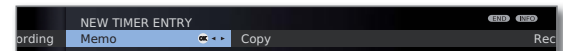

◀ ▶ Select **Memo**.  
**OK** EPG is opened.

Note desired programme as described in **Switching and memorizing with the programme list** (Seite 45).

## New entry: Copying DR archive entries<sup>(1)</sup>

⇒ Timer list is opened.

⇒ An external recorder is registered.

    **Red button:** Call **New timer entry**.



◀ ▶ Select **Copy**.  
**OK** The DR archive is opened.

See the chapter **Copying recordings** in the operating instructions of the Digital Recorder for further steps.

# External devices

## Timer recording with external devices

- ➡ The recording of HDTV stations with external devices is only possible to a limited degree. The HD transmission is scaled down to SD quality and output at the AV output for the recording.

### Recorder with Digital Link Plus

If you use an externally connected recorder with **Digital Link Plus** or a similar system, the TV set and connected recorder exchange data (e.g. compare station lists TV set/recorder or timer data of analogue stations). Please consult the operating manual of your recorder to find out if your recorder is **Digital Link Plus** compatible. In addition use only Euro-AV cables for the connection between TV set and recorder.

#### Analogue stations

The timer data are transmitted automatically from the TV set to the recorder after programming is complete. (For DVD recorders in addition the recording quality SQ or EQ is also transmitted.)

The recording is then controlled by the recorder and the recorder tuner is used for reception of the programme.

The recording data are not saved in the timer overview of the TV set. Consequently if you want to change or delete the timer data then you must do so on the recorder.

#### Digital stations

If you want to record digital stations with an externally connected recorder, then the DVB tuner is used and the TV device takes over control of the recorder. Then the station on the TV set is locked during the timer recording.

It is not possible to switch over to another DVB station.

### Copy protection

Copy-protected programmes will not be output on the EURO AV sockets for legal reasons.

## Serial interface RS-232C (RJ12) (retrofittable)

You can connect a home network system of different manufacturers (e.g. AMX, Crestron) to your TV set via the RS-232C (RJ12) interface.

Please consult your dealer for configuration of the RS-232C (RJ12) interface and further information about the different home networking systems.

# External devices

## Operating Loewe equipment

### Using the remote control for the TV mode of the TV set

**TV** Press the **TV button**, the display above it will light for approx. 5 seconds.

### Using the remote control for a Loewe recorder

**REC** Press the **REC button**, the display above it will light for approx. 5 seconds.

### Using the remote control for a Loewe player

**DVD** Press the **DVD button**, the display above it will light for approx. 5 seconds.

### Using the remote control for the radio mode of the TV set

**AUDIO** Press the **AUDIO button**, the display above it will light for approx. 5 seconds.

As long as a button is pressed, the display of the selected operating mode lights up (**TV – REC – DVD – AUDIO**). This allows you to check which operating mode the remote control is set to every time you press a button.

The **factory setting** of the buttons is described above (see also table in right hand column). The assignment of the buttons can be changed to suit the existing accessory devices (see right hand column).

### Setting the remote control for other Loewe devices

You can operate various Loewe devices with the remote control. The device keys **REC – DVD – AUDIO** can be reassigned to operate various Loewe devices.

**DVD**  Press the required device buttons and the **STOP button** simultaneously for 5 sec. until the corresponding LED display flashes twice.

Then enter the two-digit device code from the list below.

Device	Code	Factory setting
Loewe ViewVision 8106 H	10	
Loewe Viewvision, Centros 21x2	12	
<b>Loewe ViewVision DR+ DVB-T</b>	<b>13</b>	<b>REC</b>
Loewe Auro 2216 PS/8116 DT	14	
Loewe BluTech Vision	15	
Loewe Soundprojector	17	
<b>Loewe TV - Digital radio</b>	<b>19</b>	<b>AUDIO</b>
Loewe Mediacenter	20	
<b>Loewe BluTech Vision Interactive</b>	<b>21</b>	<b>DVD</b>
<b>HDMI CEC mode</b>	<b>22</b>	
Loewe AudioVision	24	
Loewe Individual Sound Projector SL	25	
Apple IR codes	26	
Resetting to factory setting	99	

The associated LED display flashes twice.

➤ The codes shown here only apply for direct operation of the accessory device.

For operation of the connected accessory device via the TV set, e.g. with concealed installation (**Code 22**), see page 94. The remote control's signal is transmitted from the TV set to the accessory device with concealed installation.

# Software update

## Basic information

It is possible to update the software on your TV set. Current software versions can be downloaded from the Loewe Internet site and installed on your set using a USB stick.

## USB stick

### Requirements of USB stick

USB sticks tested by Loewe and compatible in type and format can be ordered from the Loewe dealer using the article no. 90456.900.

If you would like to use your own USB stick, please follow these tips/conditions:

- Formatting in FAT32.
- Only 1 partition.
- Do not use encrypted USB sticks.
- Do not use USB sticks which simulate a CD ROM drive.
- There may be no hidden files on the device.
- For some types of device, the construction of the USB stick is significant. Maximum dimensions in mm: 70x20x10.
- If in doubt, the USB stick should be formatted as "FAT32" without "extended attributes".

## Download

### Software download from the Loewe Internet site

You can download new software for your TV set from our homepage. To do this register on our homepage

<http://support.loewe.tv> (International),  
<http://support.loewe.tv/uk> (United Kingdom and Republic of Ireland),  
<http://support.loewe.tv/au> (Australia) or  
<http://support.loewe.tv/nz> (New Zealand)

(under **Register now**).

Simply follow the steps in the registration process.

After the successful registration process and subsequent login to the homepage you have to register your set (have the article number and serial number ready – both are mentioned on the sticker on the rear side of the set or under **Integrated features** in the index of the TV set, see page 15).

Then you will get a list of downloadable contents for your TV set including the software for your TV set. Download the data and unpack all the files in this ZIP archive into the main directory of your USB stick.

Then carry out the software update as described below.

## Software update

In the software update (package update) all the software releases in the TV are scanned and updated as required.

To do this, insert the USB stick with the downloaded software into a free USB port on the TV set (see connections page 11).

### Calling Software update



**MENU:** Call TV menu.



◀ ▶ Select **Settings**,  
▼ go to the menu line below.

◀ ▶ Select **Miscellaneous**,  
▼ go to the menu line below.

◀ ▶ Select **Software update**,  
**OK** Call Software update Wizard.

The versions of the current software package are displayed.

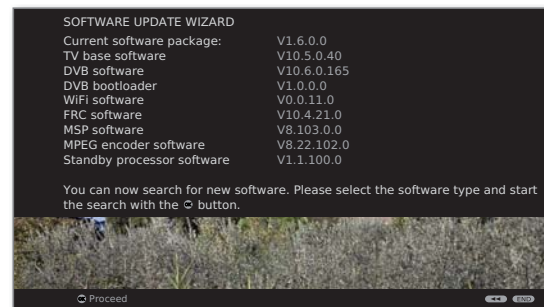

**OK Proceed.**

The TV set searches for a new software package on the USB stick.

If a new software version is available after the search, the following on-screen message appears (see page 104).

If several different software packages are found on the USB stick, the latest software package is always used.

If no new software package was found in the search:

**OK Exit wizard.**



continued on the next page →

# Software update

## New software package found

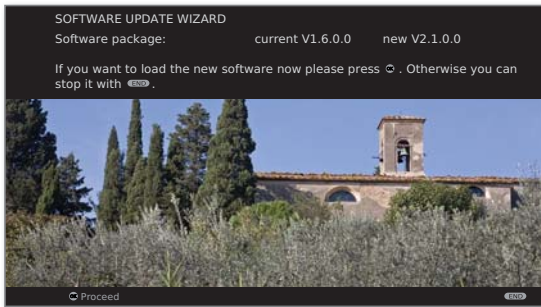

**OK Proceed.**

OK Start loading software.



**END: Exit wizard.**

## Load new software package

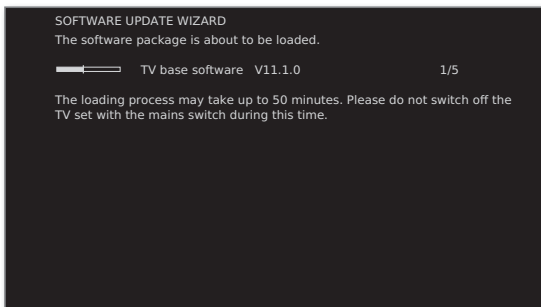

A bar shows you the progress of the download. This process can take up to 50 min. Do not turn your set off during this time!

You will be informed at the end of the update.

After finishing loading:  
Switch the TV off and back on at the mains switch.



# Input of characters

## USB keyboard

As an alternative to the remote control, you can connect a USB keyboard to the USB connection of the TV set. With this you can easily input characters to rename channels or lists of favourites.

The keyboard can completely replace the remote control. An overview of the button assignment is on the right hand side of the table.

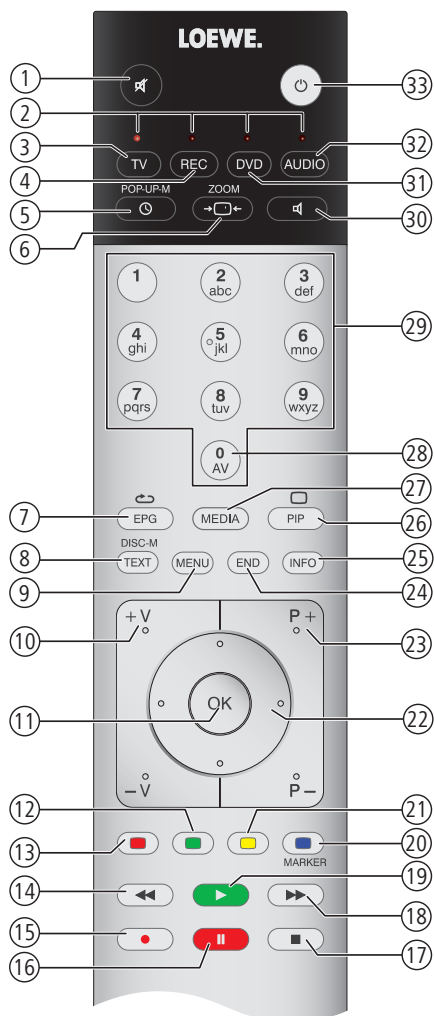

## Button combinations

Keyboard	Remote control	No.
Left and right switching button	Keyboard layout between Standard (Latin) and Greek or Russian (only for the menu languages Greek and Russian)	-
F1	Red button	13
F2	Green button	12
F3	Yellow button	21
F4	Blue button	20
F5	RECORD button	15
F6	PAUSE button	16
F7	STOP button	17
F8	PLAY button	19
F9	Button ◀◀	14
F10	Button ▶▶	18
Alt + ESC	END button	24
Enter	OK button	11
0 ... 9	Number buttons	28, 29
Pg ↑ / ↓	P+ / P- buttons	23
Alt ++ / -	V+ / V- buttons	10
Alt + F	TV button	3
Alt + R	AUDIO button	32
Alt + P	PIP button	26
Alt + T	TEXT button	8
Alt + O	Place the TV set into standby mode	33
Alt + A	MEDIA button	27
Alt + I	INFO button	25
Alt + M	MENU button	9
Alt + E	EPG button	7
Alt + S	Sound off/on	1
Alt + W	TIMER button	5
Arrow buttons	Directional buttons ◀ ▶ ▶▶ ▶▶▶	22

# Input of characters

## Character table

Key assignment for text input via the remote control For certain functions the input of letters or characters is required. As with a cell phone press the numeric button (0-9) repeatedly until the desired character appears.

- The characters available are language dependent.  
Here the key assignment is for the menu language **English**.

Button	Character (uppercase - lowercase)
1	1
2	ABC2 - abc2
3	DEF3 - def3
4	GHI4 - ghi4
5	JKL5 - jkl5
6	MNO6 - mno6
7	PQRS7 - pqr7
8	TUV8 - tuv8
9	WXYZ9 - wxyz9
0	0 [space] . \ - + _ , ; : ? ! = & # % ~ @ \$ * '   ( )

# Troubleshooting



Problem	Possible cause	Remedy
All menus are displayed in the <b>wrong language</b> .	The menu language was set incorrectly.	<b>Set the menu language:</b> Press the <b>MEDIA</b> button in <b>TV mode</b> . In the <b>MediaPortal</b> , highlight the last menu item ( <b>Index</b> ) in the upper half and call up with <b>OK</b> . Mark the first key word and call it with <b>OK</b> . Then select the language and confirm it with <b>OK</b> .
In the <b>TV menu</b> , <b>Connections</b> cannot be called (displayed in grey).	A timer recording is in progress.	Wait until the timer recording ends or delete the timer recording (page 100).
The control functions of the Loewe Recorder and the <b>Timer</b> are not working or are not working properly	a) The Digital Link function is not activated or not possible in the recorder. b) EURO-AV cable is not connected.	a) Activate Digital Link in the recorder (see operating instructions of the recorder). b) Connect EURO-AV cable (page 92).
General problems when connecting <b>external devices</b> via an <b>AV input</b> .	a) The <b>AV standard</b> is set incorrectly. b) The <b>signal type</b> is set incorrectly.	a) Set the correct standard (page 89). b) Set the correct signal type (page 89). If <b>AV standard</b> or <b>AV signal</b> is set to <b>"Automatic"</b> then this can cause errors to be detected with signals that do not comply with standards. In this case standard and signal must be set according to the information in the operating manual of the external device.
The <b>connection</b> of a <b>decoder</b> does not function or does not function properly.	a) The signal is not decoded because the correct decoder stations are not selected in the menu. b) The sound is missing in decoder mode because the wrong decoder sound is assigned in the menu.	a) Select the right decoder stations in the menu ( <b>TV menu</b> → <b>Connections</b> → <b>Miscellaneous</b> → <b>Decoder stations</b> → <b>Select decoder station(s)</b> ) (see page 90). b) Select the right sound code (always, never, automatic) in the menu ( <b>TV menu</b> → <b>Connections</b> → <b>Miscellaneous</b> → <b>Decoder stations</b> → <b>Sound encoding</b> ), see also decoder instructions.
<b>Digital Link Plus</b> does not work.	a) EURO-AV cable is not fully wired (pin 10 not wired). b) Some recorders can only adopt stations during the initial installation of the TV set.	a) Replace the EURO-AV cable. b) Restore the recorder to the as-delivered state (see recorder's operating manual).
With <b>Teletext</b> various <b>characters</b> are displayed incorrectly.	The wrong character set has been set in the Teletext menu.	Set the right character set: Select <b>Teletext menu</b> → <b>Settings</b> → <b>Character set</b> → <b>Standard</b> or the appropriate character set.
Errors occurred when running a CA module.		Switch the TV set off. Remove the CA-module from the TV set. Wait a few seconds. Reinsert the CA-module. Switch the TV set on again.

# Troubleshooting

Problem	Possible cause	Remedy
<p><b>No sound</b> via the external digital <b>audio amplifier</b>.</p>	<p>a) The external digital audio amplifier does not support the selected sound format (Dolby Digital, dts, MPEG).</p> <p>b) TV set and external digital audio amplifier are not connected with each other.</p>	<p>a) Set PCM stereo on the DVD player in the sound selection. For DVB stations on the TV set switch to stereo in the <b>Status display (INFO) – Language/sound (green button)</b>.</p> <p>b) Connect <b>AUDIO DIGITAL OUT</b> from the TV set to a <b>digital</b> input of the external digital audio amplifier and select the appropriate input to this.</p>
<p>A programmed <b>recording</b> was not made.</p>	<p>Recording of <b>analogue</b> stations with <b>VPS</b> data: The programme to be recorded was not (no longer) in the programmes offered by the station via VPS.</p> <p>Recording of <b>DVB</b> stations with <b>automatic time control</b>: The provider deleted the programme from the EPG data, for example due to a programme change.</p>	<p>The stations are exclusively responsible for the transmission of <b>VPS</b> data (for analogue stations) or for the use of the <b>automatic time control</b> (for DVB or MHEG-5 stations). The availability of the appropriate data cannot be guaranteed.</p>
<p>Despite video or music file being played back, no sound can be heard.</p>	<p>a) The TV set is set to mute or the volume has been turned down too far.</p> <p>b) An audio device that does not exist or that is not connected is registered in the <b>TV menu</b> under <b>Connections</b> → <b>Sound components</b> (e.g. <b>HiFi/AV amplifier</b>).</p>	<p>a) Increase the volume by pressing the <b>V+ button</b> on the remote control for longer. This will also cancel any mute setting.</p> <p>b) Connect up the audio device and switch it on. In the <b>Sound components wizard</b> change back to <b>TV speakers</b>.</p>
<p>A media file that is displayed can not be played back.</p>	<p>The format of the file is not supported (see also limitations in section <b>File formats supported</b> on page 112).</p>	<p>No remedy.</p>
<p>The free capacity of the external hard disk is essentially indicated smaller than expected in the OSD.</p>	<p>The hard disk has been formatted on FAT32 on a PC with Microsoft Windows (see also page 67).</p>	<p>Format external hard disk on TV set again via <b>TV menu</b> → <b>Settings</b> → <b>Miscellaneous</b> → <b>Format external hard disk</b>.</p>

# Technical data

## General data

Type	Xelos 40 LED 	Xelos 32 LED 
Article number	50424x80	50422x80
Dimensions for device without stand (W x H x D) in cm	98.4 x 64.6 x 10.3	79.8 x 54.2 x 9.8
Dimensions for device with stand (W x H x D) in cm	98.4 x 68.9 x 26.7	79.8 x 58.4 x 26.7
Weight for device without stand (approx.) in kg	17.5	13.6
Weight for device with stand (approx.) in kg	20.4	16.5
Display technology	Full-HD LCD with Edge-LED backlight	
Screen diagonal (in cm) / Picture format	101 / 16:9	80 / 16:9
Resolution (in pixels) / Motion Response	1920 x 1080 / 100 Hz	
Contrast (static / dynamic)	5,000 : 1 / 5,000,000 : 1	
Viewing angle (horizontal / vertical)	178° / 178°	
Power consumption On-Mode max. (W) (Audio output 1/8 of the maximum value)	113	90
Power consumption On-Mode Home (W) (Ambient light sensor according to ErP considered)	79	65
Power consumption in Standby Mode (W)	0.37	0.37
Power consumption when set is switched off (W)	0	0
Ambient temperature (Celsius)	5° – 35°	
Relative humidity (non-condensing)	20 – 80%	
Air pressure	800 – 1114 hPa (0 – 2000 m above sea level)	

# Technical data

## Electrical data

Chassis designation:	SL 150	
Power supply:	220 V – 240 V/50–60 Hz	
Tuner:	terr./cable: satellite <sup>(1)</sup> :	VHF/hyperband/UHF 4 levels: 13/18V/22kHz 16 levels: DiSEqC 1.0 Single cable system: EN 50494
Range:	terr./cable: satellite <sup>(1)</sup> :	45 MHz to 860 MHz 950 MHz to 2150 MHz
Station storage locations incl. AV and radio:	5000	
TV standards:	analogue: digital:	B/G, I, L, D/K, M, N DVB-T/T2 <sup>(1)</sup> , DVB-C DVB-S <sup>(1)</sup> /S2 <sup>(1)</sup>
Colour standards:	SECAM, PAL, NTSC, NTSC-V, PAL-V (60 Hz)	
Sound standards:	analogue: BG, DK, MN: BG, I, DK: L, L1: digital:	mono, stereo, dual-channel FM-A2 FM-Nicam AM-Nicam mono, stereo, dual-channel, PCM Dolby Digital Dolby Digital Plus Dolby Virtual Speaker Dolby Digital AAC+
Audio output power (music/sine):	2 x 20W / 2 x 10W	
Teletext:	TOP/FLOF Level 2.5	
Page memory:	2000	

## Signals via PC IN / HDMI

The following table lists the compatible signals which your TV set can show via the **PC IN** connection and the HDMI connections (**HDMI1**, **HDMI2**).



























Set the output signal on your PC, HDMI or DVI device so that it matches one of the signals in the table.

Format	Horizontal	x	Vertical	Image frequency	Connection
480i60	720	x	480i	60Hz	PC IN, HDMI
576i50	720	x	576i	50Hz	PC IN, HDMI
480p60	720	x	480p	60Hz	PC IN, HDMI
576p50	720	x	576p	50Hz	PC IN, HDMI
	1440	x	480p	60Hz	HDMI
	1440	x	576p	50Hz	HDMI
720p50	1280	x	720p	50Hz	PC IN, HDMI
720p60	1280	x	720p	60Hz	PC IN, HDMI
1080i50	1920	x	1080i	50Hz	PC IN, HDMI
1080i60	1920	x	1080i	60Hz	PC IN, HDMI
1080p24	1920	x	1080p	24Hz	PC IN, HDMI
1080p25	1920	x	1080p	25Hz	PC IN, HDMI
1080p30	1920	x	1080p	30Hz	PC IN, HDMI
1080p50	1920	x	1080p	50Hz	HDMI
1080p60	1920	x	1080p	60Hz	HDMI
VGA	640	x	480	60Hz	PC IN, HDMI
SVGA	800	x	600	60Hz	PC IN, HDMI
XGA	1024	x	768	60Hz	PC IN, HDMI
WXGA	1360	x	768	60Hz	PC IN, HDMI
SXGA	1280	x	1024	60Hz	PC IN, HDMI

<sup>(1)</sup> Equipment and upgrade options, see page 115.

# Technical data

## Connections (max. equipment)

Designation	Type	Function / Signal	
	Mains socket	220-240V ~ 50/60 Hz	Supply voltage
 	HDMI type A (2x)	Digital Video/Audio IN:	Digital video <sup>12</sup> and audio
	D-SUB 15-pole	Video IN:	PC/STB video signal <sup>12</sup>
	EURO-AV	Video OUT:	Y/C (S-VHS/Hi 8) CVBS (VHS/8 mm) RGB
		Audio IN:	Y/C (S-VHS/Hi 8)
		Audio OUT:	L/R L/R
	USB type A	USB 2.0:	Multimedia files/software update
	Jack 3,5 mm	Audio IN:	L/R
 AUDIO DIGITAL	Cinch (yellow)	Digital Audio OUT (SPDIF):	Digital audio output
AUDIO OUT  / 	Cinch (white / red)	Digital Audio IN (SPDIF):	L/R
	Mini-DIN		Service/L-Link
  	IEC socket	75 Ohm / 5 V / 80 mA:	Antenna/cable/DVB-T/C
   	F socket <sup>(1)</sup>	75 Ohm 13/18 V / 450 mA:	ANT-SAT DVB-S/S2
	RJ12 <sup>(1)</sup>	Data I/O:	serial interface
	Mini-DIN <sup>(1)</sup>		Rotating stand control (Positioning accuracy 1.5°)
	Jack 3,5 mm <sup>(1)</sup>		Connection for IR station
	CI slot	Common Interface:	Slot for CA module
	Jack 3,5 mm		Headphones 32–2000 Ohm
 	Cinch (white / red)	Audio IN:	L (white) / R (red)
	Cinch (yellow)	Video IN:	CVBS (VHS/8 mm)
	Mini-DIN	Video IN:	Y/C (S-VHS/Hi 8) CVBS (VHS/8 mm)

<sup>(1)</sup> Equipment and upgrade options, see page 115.

<sup>(2)</sup> For compatible picture signals, see table on page 110.

# Technical data

## MediaHome

### File formats supported

**Pictures:** **JPG, PNG, GIF**

**Audio:** **MP3, M4A** (AAC LC), **WMA** (without lossless), **FLAC, WAV (PCM)**

**Video:** **AVI** (MPEG-1/2, DivX, XviD, AC3, MP3), **WMV** (WMV9, VC-1, WMA9, WMA Pro), **MP4** (DivX, XviD, H.264/MPEG-4 AVC, AAC LC), **MOV** (H.264/MPEG-4 AVC, AAC LC), **MKV** (H.264/MPEG-4 AVC, AC3), **FLV** (H.264/MPEG-4 AVC, H.263, MP3, AAC LC), **MPG** (MPEG-1, MPEG Audio), **TS/PS** (MPEG-2, H.264/MPEG-4 AVC, MPEG2 Audio, AC3), **VOB** (MPEG-2, MPEG2 Audio, AC3)

- ➡ **DivX** up to a resolution of 720p
- ➡ **H.264/MPEG-4 AVC** up to Profile High (Level 4.2)



# Accessories

## Accessories

The following accessories are obtainable from your Loewe dealer.

### **Installation options:**

A large range of options for floor, table or wall installation are available for your TV set.

An overview of the available options can be found on page 116.

### **Loewe DVD recorder:**

The DVD recorders from Loewe are characterised by form and colour, which match Loewe TV sets, adapted user guidance and technology. Combined these devices form a system that offers many advantages.

### **Loewe Blu-ray player:**

With the Loewe Blu-ray player **BluTech Vision Interactive** you are ideally equipped for the successor format to DVD. With the Loewe system integration you control BluTech Vision Interactive and your Loewe TV set simultaneously with the Assist remote control.

### **Loewe Audiovision:**

**Audiovision** with integral 5.1 decoder creates impressive surround sound, even for televisions without a surround sound decoder.

As well as FM radio and CD/DVD player, Audiovision offers a connection for your iPod or your iPhone. Plus, thanks to video upscaling 1080p, you can also experience DVDs in full HD resolution.

### **Loewe Vesa adapter bolts:**

You can purchase adapter bolts for wall holders in line with the VESA standard from your dealer or the Technical Customer Service (see service addresses on page 126). Four items are required.

Spacer bolts (1 item) Loewe order no. 70873.001.

## Upgrade kits / conversion kits / cables

### **Module DVB-S2 Single (Art.No. 70622.080):**

You can receive digital satellite and HDTV stations with the upgrade kit. The tuner is integrated in the TV set and is operated with the remote control/menu control.

The retrofit possibilities for your set can be found in the table on page 115.

### **Module RJ12 / Motor Unit / IR-Link (Art.No. 70493.080):**

The TV set can be connected to a home network system via the RS-232C (RJ12) interface.

The infrared function enables pieces of auxiliary equipment of other manufacturers to be operated, even if they are covered up. You operate the auxiliary equipment with its respective remote control via the Loewe TV set.

The retrofit possibilities for your set can be found in the table on page 115.

### **Module DVB-T2/C Single (Art.No. 70913.080):**

With the DVB-T2/C Single conversion kit you add the Standard DVB-T2 to the reception possibilities of your TV set.

The Standard DVB-T2 is not available in all countries at the moment

The retrofit possibilities for your set can be found in the table on page 115.

### **USB extension (Art.No. 70167.080):**

To ensure easy accessibility of the USB connection or enable USB sticks to be inserted with a large casing, the TV set can be connected to a USB extension.

This upgrade kit is available from your technical customer service (see service addresses on page 126).

# Accessories

## Equipment variants

The equipment of the individual set variants and their upgrade/conversion possibilities is listed in the table below.

Set variants	Xelos 40 LED	Xelos 32 LED
USB Recording	●	●
DVB-T/C Single	●	●
DVB-T2/C Single Art.No. 70913.080	□	□
DVB-S2 Single Art.No. 70622.080	○	○

- ex factory
- optionally available as an upgrade kit
- optionally available as a conversion kit

## TV set equipment

See the rating plate on the rear of the set for the precise product designation. The precise features are listed in the **Integrated features** item in the index of the TV set (see page 15).

# Accessories

## Setup possibilities

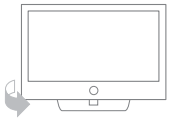

Table Stand



Wall Mount WM62



Wall Mount Flex 32 L<sup>(1)</sup>

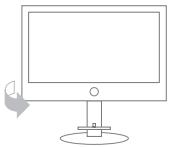

Floor Stand A 32-46

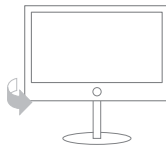

Floor Stand 8 32-40<sup>(1)</sup>

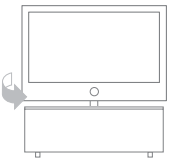

Rack 110.30<sup>(1)</sup>  
Rack 110.30 SW<sup>(1)</sup>

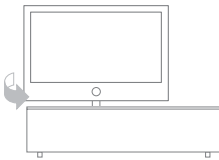

Rack 165.30<sup>(1)</sup>

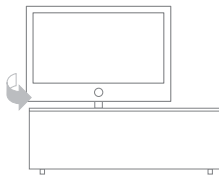

Rack 165.45 CS<sup>(1)</sup>  
Rack 165.45 SP<sup>(1)</sup>

### Xelos 40 LED

- Table Stand Xelos 40 (scope of delivery)
- Wall Mount WM62
- Wall Mount Flex 32 L<sup>(1)</sup>
- Floor Stand A 32-46 (Equipment Board optionally available)
- Floor Stand 8 32-40<sup>(1)</sup>
- Rack 110.30<sup>(1)</sup>
- Rack 110.30 SW<sup>(1)</sup>
- Rack 165.30<sup>(1)</sup>
- Rack 165.45 CS<sup>(1)</sup>
- Rack 165.45 SP<sup>(1)</sup>

### Xelos 32 LED

- Table Stand Xelos 32 (scope of delivery)
- Wall Mount WM62
- Wall Mount Flex 32 L<sup>(1)</sup>
- Floor Stand A 32-46 (Equipment Board optionally available)
- Floor Stand 8 32-40<sup>(1)</sup>
- Rack 110.30<sup>(1)</sup>
- Rack 110.30 SW<sup>(1)</sup>
- Rack 165.30<sup>(1)</sup>
- Rack 165.45 CS<sup>(1)</sup>
- Rack 165.45 SP<sup>(1)</sup>

<sup>(1)</sup> Only in connection with appropriate adapter to be ordered separately.

# Environment

## Environmental protection

### Energy consumption

Your TV set is equipped with an eco-standby power supply. In the standby mode, the power consumption drops to low power (see Technical data on page 109). If you want to save even more energy then switch the device off with the mains switch. Please also note that the EPG data (Electronic Programme Guide) is lost under certain circumstances and possibly programmed timer recordings **cannot** be carried out via the TV set.

The power consumed by the TV set during operation depends on the energy efficiency preset in the initial installation (see page 21) or the setting in the TV menu (see page 33).

If you activate the automatic dimming (see page 33), your TV picture will adapt to the ambient brightness. This reduces the power consumption of the TV set.

### Packaging and box

You have made a decision to purchase a high-quality technical product with a long service life. For disposal of the packaging, in accordance with national legislation we have paid a fee to a commissioned recycler to pick up the packaging from the dealer.

### The set



The EU directive 2002/96/EC regulates the proper way to recycle, handle and utilise used electronic devices. **Old electronic devices** consequently must be disposed of separately. Please do **not** dispose of this device in normal **household trash!**

You may return your used set free of charge at designated recycling centres or at your specialist dealer whenever you purchase a new, comparable set. Additional details about return (also for non EU countries) are available from your local municipal authorities.

### Batteries



The batteries supplied as initial equipment do not contain any pollutants such as cadmium, lead, or mercury. Used batteries should **no longer** be disposed of in the **domestic waste** according to the Battery Ordinance. Dispose of your batteries at no charge in the **collection containers** which are set up for this purpose in retail stores.

 The code number  cancels an access code and thus the parental lock. Please keep in a safe place.

## Trademarks

Manufactured under licence from Dolby Laboratories. "Dolby", "Pro Logic" and the double-D symbol are trademarks of Dolby Laboratories.

Manufactured under license under U.S. Patent #'s: 5,451,942; 5,956,674; 5,974,380; 5,978,762; 6,487,535 & other U.S. and worldwide patents issued & pending. DTS and DTS Digital Surround are registered trademarks and the DTS logos and Symbol are trademarks of DTS, Inc. © 1996-2007 DTS, Inc. All Rights Reserved.



The screen font "Loewel2700" is based on the "Tavmjong Bah Arev (tavmjong.free.fr)" font, which in turn is based on "Bitstream Vera". Bitstream Vera is a trademark of Bitstream Inc.

This set contains a software which is based partly on the work of the Independent JPEG Group.

DivX and the corresponding DivX logos are registered trademarks of DivX, Inc.

This product includes software developed by the OpenSSL Project for use in the OpenSSL Toolkit (<http://www.openssl.org/>).

This software is provided by the OpenSSL project "as is" and any expressed or implied warranties, including, but not limited to, the implied warranties of merchantability and fitness for a particular purpose are disclaimed. In no event shall the OpenSSL project or its contributors be liable for any direct, indirect, incidental, special, exemplary, or consequential damages (including, but not limited to, procurement of substitute goods or services; loss of use, data, or profits; or business interruption) however caused and on any theory of liability, whether in contract, strict liability, or tort (including negligence or otherwise) arising in any way out of the use of this software, even if advised of the possibility of such damage.

This product includes cryptographic software written by Eric Young (eay@cryptsoft.com).

This product includes software written by Tim Hudson (tjh@cryptsoft.com).

This product contains software which was developed by third parties and / or software which is subject to GNU General Public License (GPL) and/or GNU Lesser General Public License (LGPL). You can pass on and modify them in accordance with Version 2 of the GNU General Public License or optionally every later version which is published by the Free Software Foundation.

Loewe publishes this programme WITHOUT ANY GUARANTEE OR SUPPORT especially without an implicit guarantee of MARKET MATURITY or APPLICABILITY FOR A CERTAIN PURPOSE. Details can be found in the GNU General Public License. You can order the software from Loewe Customer Service.

You can download the GNU General Public License here: <http://www.gnu.org/licenses/>.

# Glossary

## 0-9

**24p movie display:** Films released on Blu-ray Disc support presentation of 24p cinema films. The Blu-ray player transfers the original film format to the television with 24 frames per second. The DMM (DigitalMovieMode) set in the factory calculates and inserts additional intermediate pictures, which suppress film jerking typical for the cinema, thereby providing for a smooth motion sequence.

## A

**Active antenna:** An antenna with its own power supply or amplification which can improve the reception in areas with a poor coverage.

**Automatic time control:** Similar to **VPS** for analogue stations the automatic time control monitors the start and end times of programmes from DVB stations. If these times deviate from the data programmed in the timer data the running time of the recording is adapted automatically. The automatic time control is not supported by all DVB stations.

**AVI:** Abbreviation for Audio Video Interleave, a video container file format developed by Microsoft. A single AVI video file can contain several audio, video and text data streams (thus the name container format).

**AV socket:** Socket for audio and video signals.

**AV sources:** Audio/video source.

**AVS:** Audio/video sockets on the side of the TV set (cinch and mini-DIN).

## B

**Band:** Name for a transmission range.

**Blu-ray Disc:** The follow-up format of **DVD**. The contents of about five DVDs fit onto one Blu-ray Disc (abbreviated BD). Therefore, the Blu-ray disc provides enough space for high-resolution images and multi-channel sound formats.

**BMP:** Abbreviation for Bitmap, a grid graphics format designed for Microsoft Windows and OS/2 that is wide spread and therefore supported by almost every popular graphics software package without any problems.

## C

**CA module:** The **Conditional Access module** contains the coding system and compares the transmitted code with the one on the **Smart Card**. If they match, the appropriate stations or programmes are decoded.

**CEC:** Abbreviation for Consumer Electronics Control. CEC provides universal component control functions for entertainment electronics devices (e.g. System standby, One Touch Play). CEC is also known as **Digital Link HD** at Loewe.

**Cinch cable:** Cable for transmitting audio or video.

**CI slot:** See **Common Interface**.

**Common Interface:** The Common Interface (CI slot) is a standardised interface. By inserting suitable decoding modules (**CA modules**) and a **Smart Card** coded digital programmes can be used.

**Common Interface Plus:** CI Plus is an advanced development of the **Common Interface** standard. CI Plus slots are in principle downward compatible to the previous CI standard, i.e. CA modules and Smart Cards according to the past CI standard can continue to be used in CI Plus slots, as far as the programme provider permits this. Additionally, extended regulations apply however to CI Plus.

**Component IN:** Connection in which the video signal is transmitted via three separate cinch connections. It is made up of the brightness signal "Y" and the colour difference signals "Pb" and "Pr". **YPbPr** is the original analogue version of the digital **YCbCr** in which video data saved on the DVD as well as transmitted via satellite, cable or antenna in DVB are colour coded.

**Conditional Access module:** See **CA module**.

## D

**Decoder:** Analogue, coded TV signals are passed through a decoder and made visible again.

**Digital Link:** System for controlling recorders (for video and DVD recorders from Loewe) via the Euro AV sockets of the Loewe TV set with concealed setup. Controlling the recorder for timer recordings.

**Digital Link HD:** System for controlling devices via the HDMI connection of the Loewe TV set in the case of concealed installation.

**Digital Link Plus:** System for controlling recorders according to protocol 50. For analogue stations the station and timer data are transmitted via the EURO-AV socket to the recorder. The timer recording is executed exclusively by the recorder. There is a different designation with different manufacturers.

**DivX:** Video Codec which allows even large files to be relatively highly compressed in their file size without having to tolerate important quality losses.

**Dolby Digital:** Digital multi-channel audio. The digital standard for high quality home movie systems. The individual channels are broadcast separately in this standard. The three front channels right, left and centre, the two surround channels right and left and the external subwoofer channels are called a 5:1 signal.

**Dolby Pro Logic:** Analogue multi-channel audio. Converts a Dolby-coded stereo signal into a surround sound. This usually contains four channels (front left, centre, front right, surround channel). A special subwoofer channel is not generated in this method.

**Dolby Pro Logic II:** Analogue multi-channel audio. Dolby Pro Logic II is a further development of **Dolby Pro Logic**. This method generates a 6-channel spatial sound from a stereo or Pro-Logic signal (front left, centre, front right, surround left, surround right, subwoofer).

**Dolby Surround:** Analogue multi-channel audio system that brings four audio channels down to two audio tracks with the aid of a matrix coding.

# Glossary

## D (continue)

**Dolby Virtual Speaker:** The Dolby Virtual Speaker technology simulates the surround playback of a real 5.1-channel playback with only two speakers.

**DRM:** Digital Rights Management. Processes to control copyright protected data. To be used correctly, DRM protected contents require not only a DRM capable device but also the possession of a license issued by the provider (to be paid for).

**DTS:** Digital Theater Systems; Digital multi-channel audio.

**DVB-C/-S/-T:** Digital Video Broadcasting stands for digital television. Technical DVB is the standardised process for transmitting digital content (television, radio, multi-channel audio, room sound, **EPG**, Teletext, and other supplemental services) through digital technology. **C** stands for transmission via cable, **S** for distribution via satellite and **T** for terrestrial or antenna distribution.

**DVD:** Abbreviation of Digital Video Disk and later Digital Versatile Disk.

**DVD preceiver:** Combi-device of DVD player and radio without integrated amplifier.

**DVI:** Digital Visual Interface, is an interface for transmitting digital video and graphic data (without audio).

**Dynamic contrast ratio:** Here the light intensity of the display is adapted in case of a high black portion in the picture. The so-called backlights are dimmed automatically and the contrast ratio increases temporarily, i.e. dynamically.

## E

**Electronic Programme Guide:** See **EPG**.

**EPG:** Electronic Programme Guide is the electronic variant of a printed TV guide. Using the EPG you can watch the TV programme of the TV station, transfer the appropriate data. The list of programmes contains the title, beginning and end and duration of the programme. In addition brief descriptions of the content of the programmes is also displayed.

**Euro AV socket:** Interface for connecting video devices to a TV set. This socket is also referred to as Scart socket.

## F

**FLOF:** Full Level One Facilities. Teletext system in which names and numbers of the jump destinations are transmitted in the bottom line on every page. This guides the reader to related topics for example. An information about which pages exist and which pages have sub-pages is not available in FLOF.

## H

**HD-CP:** High-bandwidth Digital Content Protection. Coding system provided for the **DVI** and **HDMI** interfaces for secure transmission of audio and video data.

**HDMI:** High Definition Multimedia Interface is a newly developed interface for full digital transmission of audio and video data.

**HDTV:** High Definition Television is an umbrella term that covers a number of high resolution television standards.

**HD-Ready:** A quality seal that is awarded to products that are capable of displaying high-definition television (**HDTV**).

**High band and Low band:** Transmission ranges for satellites.

## I

**ID3 tags:** Additional information for MP3 and WMA audio files. Information about the singer, title, album and album cover can be saved here among other things. These data are edited on the PC by an ID3 tag editor.

**IR-Link:** The IR-Link function allows the operation of accessory devices with concealed installation made by other manufacturers via the Loewe TV set. The infrared sensor required for this is available as an accessory and can be connected to the IR-Link connection of the TV set.

## J

**JPEG/JPG:** Joint Photographic Experts Group is a committee which has developed a standard method for the compression of digital photos. This method JPEG (**JPG** for short), named after the committee, is a commonly used graphic format for photos.

## L

**LCD:** Liquid Crystal Display.

**LCN:** Logical Channel Numbers. In stations with LCN, the channel location number belonging to the station is also transmitted by the provider. The stations are sorted according to these channel location numbers.

**L-Link:** Intelligent system connection between Loewe devices for the automatic exchange of information. Makes the operation of TV and Loewe system components even more convenient.

**LNB/LNC:** The crucial electronic component of a satellite antenna is referred to as an LNB (Low Noise Block Converter). It is mounted in the focal point of a parabolic antenna. The designation **LNC** (Low Noise Converter) indicates that conversion to lower intermediate frequency takes place. The supplemental block in the LNB refers to the fact that a whole frequency range (a block) is converted in each case.



# Glossary

## M

**MHEG-5:** Digital teletext standard of the Multimedia and Hypermedia Expert Group. At the moment only available in United Kingdom and Ireland.

**Modulator:** Transmitter in the video or DVD recorder so that the devices can receive signals via the tuner of the TV device.

**Mono:** Single-channel audio.

**MPEG:** Digital compression process for video.

**MP3:** Data format for compressed audio files.

**Multimedia contents:** Videos, music files and photos are grouped together under this term.

## N

**Network ID:** NID refers to the so-called programme ID number, also known as network ID – a number between 0 and 8191. This specification is necessary in specific cable networks of some countries. Then only DVB signals of this station network are searched for.

**NICAM:** Audio standard. Is used in Denmark, England, France, Sweden, and Spain.

**NTSC:** American colour standard.

## P

**Page Catching:** For teletext, refers to going to and calling a page number.

**PAL:** European standard.

**PCM:** Pulse Code Modulation for digital sound.

**Picture in Picture:** See **PIP**.

**PIP:** Picture in Picture; a function which displays two pictures on the screen.

**Pixel:** Denotes both the smallest unit of a digital graphic grid and its display on a screen with grid control.

**Pixel error:** A pixel error is a defective pixel, usually on an LCD. Pixel errors may be caused by production errors. They are expressed for example by a constantly lit pixel or a constantly black pixel. Single defective pixels however are excluded from a guarantee.

**PNG:** Abbreviation for Portable Network Graphics, a freely available grid graphics format for loss-free compression.

**Progressive JPEG:** Progressive **JPEGs** are built up gradually. The quality of the picture increases progressively during the loading process.

**ProScan/Progressive Scan:** Progressive Scan (abbr. PS) or full picture method is a technique in the picture build-up of monitors, TV sets, beamers, and other display devices in which the output device is not sent line interlaced half pictures – unlike in the interlace technique – but real full pictures.

## R

**RGB:** Colour signals red, green and blue.

## S

**Satellite tuner:** Receiver for satellite programmes.

**SDTV:** Standard Definition TeleVision.

**SECAM:** French colour standard.

**Set-Top-Box:** Set-Top-Box (STB for short) refers to a device in entertainment electronics which is connected to another device, usually a TV set, and offers the user additional functional options.

**Signal input groups:** Depending on the applied signal, the signal sources are divided into different groups. All signal input groups with their corresponding signal types and the possible inputs are listed below.

### TV analogue:

Signal type: FBAS, YC, RGB-SD (480i/576i), Component-SD (480i/576i)  
Input: Tuner analogue, AV, AVS

### TV digital:

Signal type: DVB-SD, HDMI-SD (480i/576i)  
Input: Tuner digital, HDMI1, HDMI2

### HD analogue:

Signal type: RGB-HD (video mode: e.g. 1920x1080, 1280x720),  
Component-HD (video modes: e.g. 1920x1080, 1280x720)  
Input: PC IN

### HD digital:

Signal type: DVB-HD, HDMI-HD  
Input: Tuner digital, HDMI1, HDMI2

### PC:

Signal type: RGB  
(PC modes: e.g. 800x600, 1024x768, 1280x1024, 1360x768)  
Input: PC IN

### PhotoViewer:

Input: USB

**Signal strength:** Strength of the received antenna signal.

**Signal quality:** Quality of the incoming antenna signal.

# Glossary

## S (continue)

**Smart Card:** The Smart Card is an electronic chip card issued by the respective programme provider or by the certification-free Pay-TV operators. It contains the code which is decoded by the **CA module**.

**Static contrast ratio:** Describes the difference between the brightest and darkest picture display.

**Stereo:** Dual-channel audio.

**Switch voltage:** Video devices specify this voltage to switch the TV device to playback.

**Symbol rate:** Describes the transmission speed for data transmission.

## T

**Terrestrial:** In data transmission a wireless transmission that does not use satellites as intermediate station is referred to as terrestrial.

**TFT:** Thin Film Transistor. One widely distributed application is control of liquid crystal flat screens, for which a signal transistor is used for each pixel. This design of display is also referred to as active matrix, however it is frequently also referred to as TFT display.

**TOP:** Table of Pages. Teletext system in which the individual pages are divided into topics. The blocks stand for a higher hierarchy level (e.g. News, Sport, Programmes) and the groups for the level below (e.g. Home/Abroad, Football/Tennis). Abbreviations can be assigned to the pages which are displayed in colour on the bottom line and can be selected with the four coloured buttons on the remote control. Information is also transmitted about which pages exist and which of them have sub-pages.

**Tuner:** Another term for receiver.

## U

**USB:** Universal Serial Bus. Serial bus system for connecting external devices (USB card reader, USB stick).

## V

**VGA:** PC interface for connecting a monitor.

**VPS:** The Video Programming System (VPS) is a signal which some (but not all) analogue TV stations transmit in the blanking gap. The signal is used by video and DVD recorders when recording programmes to react to delays in start time, programme changes and excesses of the planned programme time.

## W

**WMA:** Abbreviation for Windows Media Audio, Microsoft's own audio data format. The contents are compressed as in MP3 files.

**WMV:** Abbreviation for Windows Media Video, Microsoft own video data format.

## Y

**Ycc/Ypp:** Colour standards for **Set-Top-Boxes**.

**YCbCr:** Digital colour model, see **COMPONENT IN**.

**YPbPr:** Analogue colour model, see **COMPONENT IN**.

# Index

- 0-9**
- 24p format .....93
- A**
- Access code .....52
- Active loudspeakers .....97
- Adjusting the picture.....33
- Adjusting the sound.....31
- Alarm .....53
- Allow switching voltage.....89
- Antenna DVB .....89
- Archive playback.....78
- Audio adjustment .....31
- Audio amplifiers.....98
- AUDIO button..... 20, 102
- Audio commentary ..... 22, 31, 32
- Audio commentary volume.....31
- Auto dimming - Room .....33
- Auto dimming - Video (VBD+) .....33
- Auto format.....33
- Automatic speech detection.....32
- Automatic time control.....86
- AV audio signal.....32
- AV standard.....89
- B**
- Balance.....32
- Batteries .....19
- Blu-ray player.....93
- Bookmarks
  - Delete all..... 80, 83
  - Delete individual.....78
  - Jumping to.....78
  - Set ..... 77, 78
- Brightness.....33
- Bundling the Cables.....19
- Button combinations.....105
- Button functions.....35
- C**
- Call Digital Recorder menu.....68
- Camcorder.....91
- CA module .....55
- Change favourites lists .....42
  - Add station .....42
  - Delete station.....42
  - Move station.....42
  - Rename list .....42
- Change station .....41
  - Delete station.....41
  - Move station.....41
  - Rename station.....41
  - Restore station.....41
- Changing the title of a recording.....83
- Character Table.....106
- CI slot.....55
- Cleaning and care.....9
- Code number.....52
- Coloured buttons..... 35, 38, 47
- Colour intensity.....33
- Colour temperature.....33
- Common Interface Plus..... 87, 88
- Connecting antennas.....18
- Connecting the TV Set.....18
- Connections .....11
- Contrast.....33
- Control unit .....10
- Copy protection.....101
- Copy recordings
  - onto an external hard disc.....81
  - to a connected recorder .....81
- D**
- Data capture.....46
- Decoder.....90
- Decoder stations.....90
- Delete Manager.....75
  - Set delete protection in the Timer data menu.....74
  - Setting/cancelling delete protection.....85
- Delete programmed descrambling.....81
- Deleting.....80
  - All bookmarks ..... 80, 83
  - Individual bookmarks.....78
  - Parts of the recording .....80
  - Recording.....82
- Deleting timer entries.....75
- Descramble scrambled recording.....82
- Device at connection AV .....89
- Digital camera.....91
- Digital Link HD (HDMI CEC).....94
- Digital Link Plus..... 90, 101
- Digital Noise Control.....33
- Digital teletext .....49
- Direct recording .....70
  - One Touch Recording.....70
- Display.....20
- DVB character set .....38
- DVB subtitles .....35
- DVD button .....102
- DVD player .....93
- DVD recorder.....93
- DVI/HDMI .....93
- E**
- Encrypted stations..... 22, 23, 26, 39, 55
- Energy efficiency ..... 15, 21
- Environmental protection.....117
- EPG .....45
- F**
- Factory settings picture/sound.....34
- Fast forward and rewind ..... 77, 79
- Favourites .....30
- Film quality impr. (DMM).....33
- First installation wizard.....21
- FLOF .....47
- Formatting the hard disc.....86
- G**
- Game console..... 90, 93
- Gaming mode.....90
- H**
- HDMI.....93
- HDMI CEC .....94
- Headphone volume.....31
- Help.....15
- HiFi/AV amplifier .....98
- Home networking system .....101
- I**
- Index in the TV set .....15
- Info display .....15
- Inform about hidden sections.....68
- Installing the TV set.....18
- Interactive data services .....49
- J**
- Jump distance.....68
- Jumping..... 76, 79
- Jumping to bookmarks.....78
- Jump to automatically set bookmarks.....76

# Index

## L

Language.....	21, 53, 107
Language/sound.....	38
Last station.....	35
LNC/LNB.....	24, 25, 26
Locking/unlocking a movie.....	84
Logical Channel Number.....	22
Loudness.....	31

## M

Mains switch.....	10, 20
Manual station search.....	40
Maximum volume.....	32
Max. switch on volume.....	32
Media	
Quit.....	56
MediaHome.....	58
Media menu.....	57
MediaMusic.....	61
MediaPhoto.....	62
Full-screen mode.....	62
Rotate picture.....	62
Slide show.....	62
MediaPortal.....	14
MediaVideo.....	63
Jumping.....	64
Playback.....	63
Select language/sound.....	64
Wind.....	64
Memorise.....	45
Menu language.....	15
Menu operation.....	12
Mobile phone keypad.....	12
Move picture vertically.....	34
Muting.....	31

## N

Numeric buttons.....	12, 15, 29
----------------------	------------

## O

On/Off button.....	10
On-screen displays.....	54
OPC.....	33
Overview diagram.....	16

## P

Page selection.....	47
Parental lock.....	52, 84
PC IN.....	95
Personal text pages.....	35, 48
Picture.....	33
Picture adjustment.....	33, 34
Picture format.....	33, 34
PALplus.....	34
Panorama.....	34
Zoom.....	34
Picture in Picture.....	43
PIN.....	52
PIP.....	43
Programme info.....	35

## R

Radio menu.....	17, 50
Radio mode.....	20, 49
REC button.....	102
Record conflict.....	75
Recording.....	99
Recording wizard.....	73, 99
Remote control.....	3, 19, 102
Remote TV switch on via Digital Link.....	90
Repeat initial installation.....	21
Reset picture/sound.....	34
RS-232C interface.....	101

## S

Safety.....	8, 9
Scope of delivery.....	7
Search wizard.....	39
Selecting audio/video source.....	30
Select satellite installation.....	23
Select station.....	29
via favourites lists.....	30
with P+/P-.....	29
with the numeric buttons.....	29
with the station list.....	29
Serial interface.....	101
Serial recording tolerance.....	68
Set bookmark.....	77, 78
Set covers.....	18
Setting pre-record time and post-record time.....	69
Set-Top-Box.....	93
Sharpness.....	33

Signal type.....	89
Slow motion.....	77, 79
Smart Card.....	55
Smart Jump.....	68, 76, 79
Software download.....	103
Software update.....	103
Sound.....	31
Sound adjustment.....	31
Sound components wizard.....	96
Sound effects.....	31
Sound off.....	31
Sound-picture synchronisation.....	31
SOUND via.....	31
Speaker system.....	97
Standby mode.....	20
Station list.....	29
Station search/update.....	39
Status display.....	37, 71
Stop recording early.....	71
Subtitles.....	35, 38
Subwoofer.....	97
Switching off.....	20
Switching off the TV set during recording.....	71
Switching on.....	20
Switch on TV when marked.....	46
Switch to live picture.....	76

## T

Teletext.....	47
Teletext functions.....	35
Teletext subtitles.....	35
Time.....	36
Time and date.....	54
Timer data.....	74, 99
Automatic time control.....	99
Auto time control.....	74
Date.....	74, 99
Decoding overnight.....	74, 99
Descrambled recording.....	74, 99
Lock movie.....	74
Programme provider PIN.....	74, 99
Recorder.....	74, 99
Recording time.....	74, 99
Recording type.....	74, 99
Record subtitles.....	74, 99
Set delete protection.....	74
Station.....	74
VPS.....	99

# Index

Timer functions .....	53
Timer overview .....	72, 73, 75, 100
Timer recording.....	72
manually .....	73
via EPG.....	72
via teletext .....	73
Timer recordings.....	99
TOP .....	47
TOP table .....	47
TV button .....	19, 102
TV menu .....	16
TV set equipment.....	115
TV viewing with time shift.....	70, 76

## U

USB keyboard .....	105
USB stick.....	103

## V

Videotext subtitles .....	48
Viewing a locked movie .....	84
Viewing another movie from the archive during archive recording .....	71
Volume.....	31
Volume adjustment.....	32
VPS.....	86
VPS times.....	48

# Service

**A** Loewe Austria GmbH  
Parkring 12  
1010 Wien, Österreich  
Tel +43 - 810 0810 24  
Fax +43 - 1 22 88 633 - 90  
E-mail: loewe@loewe.co.at

**AUS NZ**  
Audio Products Group Pty Ltd  
67 O'Riordan St  
Alexandria NSW 2015, Australia  
Tel +61 - 2 9669 3477  
Fax +61 - 2 9578 0140  
E-mail: help@audioproducts.com.au

**B NL L**  
Loewe Opta Benelux NV/SA  
Lilienbaan 84  
2160 Wommelgem, België  
Tel +32 - 3 - 2 70 99 30  
Fax +32 - 3 - 2 71 01 08  
E-mail: ccc@loewe.be

**BG** SOFIA AUDIO CENTRE  
138 Rakovski St.  
1000 Sofia, Bulgaria  
Tel +359 - 29 877 335  
Fax +359 - 29 817 758  
E-mail: sac@audio-bg.com

**CH** Telion AG  
Rütistrasse 26  
8952 Schlieren, Schweiz  
Tel +41 - 44 732 15 11  
Fax +41 - 44 732 15 02  
E-mail: lgelpke@telion.ch

**CY** Hadjikyriakos & Sons Ltd.  
121 Prodomos Str., P.O Box 21587  
1511 Nicosia, Cyprus  
Tel +357 - 22 87 21 11  
Fax +357 - 22 66 33 91  
E-mail: sawas@hadjikyriakos.com.cy

**CZ** BaSys CS s.r.o.  
Sodomkova 1478/8  
10200 Praha 10 - Hostivar, Česko  
Tel +420 2 34 70 67 00  
Fax +420 2 34 70 67 01  
E-mail: office@basys.cz

**D** Loewe Opta GmbH,  
Customer Care Center  
Industriestraße 11  
96317 Kronach, Deutschland  
Tel +49 180122256393  
Fax +49 926199500  
E-mail: ccc@loewe.de

**DK** Kjaerulff1 Development A/S  
C.F. Tietgens Boulevard 19  
5220 Odense SØ, Denmark  
Tel +45 - 66 13 54 80  
Fax +45 - 66 13 54 10  
E-mail: info@loewe.dk

**E** Gaplasa S.A.  
Conde de Torroja, 25  
28022 Madrid, España  
Tel +34 - 917 48 29 60  
Fax +34 - 913 29 16 75  
E-mail: loewe@maygap.com

**EST** Tedra Trading Oy  
Kuusemetsa 3  
Saeue 76506, Estonia  
Tel +372 - 50 14 817  
Fax +372 - 67 09 611  
E-mail: info@futurehifi.com

**F** Loewe France SAS  
Rue du Dépôt,  
13 Parc de l'Europe, BP 10010  
67014 Strasbourg Cédex, France  
Tel +33 - 3 - 88 79 72 50  
Fax +33 - 3 - 88 79 72 59  
E-mail: loewe.france@loewe-fr.com

**FIN** Karevox Oy  
Museokatu 36  
00100 Helsinki, Finland  
Tel +358 - 9 44 56 33  
E-mail: kare@haloradio.fi

**GB IRL** Loewe UK Limited  
Century Court, Riverside Way  
Riverside Business Park, Irvine, Ayrshire  
KA11 5DJ, UK  
Tel +44 - 1294 315 000  
Fax +44 - 1294 315 001  
E-mail: enquiries@loewe-uk.com

**GR** Issagogiki Emboriki Ellados S.A.  
321 Mesogion Av.  
152 31 Chalandri-Athens, Hellas  
Tel +30 - 210 672 12 00  
Fax +30 - 210 674 02 04  
E-mail: christina\_argyropoulou@isembel.gr

**H** Basys Magyarorszag KFT  
Tó park u.9.  
2045 Törökbálint, Magyar  
Tel +36 - 2341 56 37 (121)  
Fax +36 - 23 41 51 82  
E-mail: ertekesites@basys.hu

**HK CN** Galerien und PartnerPlus  
Kings Tower 28D, 111 King Lam Street  
Kowloon, Hong Kong  
Tel +852 -92 60 89 88  
Fax +852-23 10 08 08  
E-mail: info@loewe-cn.com

**HR** Plug&Play Ltd.  
Bednjanska 8, 10000 Zagreb  
Hrvatska (Kroatia)  
Tel +385 1 4929 683  
Fax +385 1 4929 682  
E-mail: info@loewe.hr

**I** Loewe Italiana S.r.l.  
Largo del Perlar, 12  
37135 Verona (VR), Italia  
Tel +39 - 045 5281690  
Fax +39 - 045 82 51 622  
E-mail: info@loewe.it

**IL** Clear electronic entertainment Ltd  
13 Noah Mozes St.  
Agish Ravad Building  
Tel Aviv 67442, Israel  
Tel +972 - 3 - 6091100  
Fax +972 - 3 - 6092200  
E-mail: info@loewe.co.il

**KSA** Salem Agencies & Services Co.  
Hamad Al Haqueel Street, Rawdah,  
Jeddah 21413  
Kingdom of Saudi Arabia  
Tel +966 (2) 665 4616  
Fax +966 (2) 660 7864  
E-mail: hkurkjan@aol.com

**LT** A Cappella Ltd.  
Ausros Vartu 5, Pasazoo skg.  
01129 Vilnius, Lithuania  
Tel +370 - 52 12 22 96  
Fax +370 - 52 66 66 81  
E-mail: info@loewe.lt

**LV** Loewe. service center  
Brivibas gatve 332,  
Riga, Latvia, LV-1006  
Tel +371 673 105 68  
E-mail: dom332@dom332.lv

**M** Doneo Co. Ltd  
34/36 Danny Cremona Street  
Hamrun, HMR1514, Malta  
Tel +356 - 21 - 22 53 81  
Fax +356 - 21 - 23 07 35  
E-mail: service@doneo.com.mt

**MA** Somara S.A.  
377, Rue Mustapha El Maani  
20000 Casablanca, Morocco  
Tel +212 - 22 22 03 08  
Fax +212 - 22 26 00 06  
E-mail: somara@somara.ma

**N** Pce. Premium Consumer  
Electronics as  
Ostre Kullerød 5  
3241 Sandefjord, Norge  
Tel +47 - 33 29 30 46  
Fax +47 - 33 44 60 44  
E-mail: service@pce.no

**P** Mayro Magnetics Portugal, Lda.  
Rua Professor Henrique de Barros  
Edifício Sagres, 2º. C  
2685-338 Prior Velho, Portugal  
Tel +351 - 21 942 78 30  
Fax +351 - 21 940 00 78  
E-mail: geral.loewe@mayro.pt

**PL** Tele Radio Video  
Ul. Boh. Getta Warszawskiego 18  
81-609 Gdynia  
Tel. 58 624-50-09  
E-Mail: loewe@trv.com.pl

**RO** Avitech Co. SRL  
1/II Pipera Tunari St.  
007190 Voluntari, Ilfov, Romania  
Tel +40 - 21 200 64 64  
Fax +40 - 21 200 64 65  
E-mail: gina.surghila@avitech.ro

**RUS** Service Center Loewe  
per. Aptekarsky, dom 4 str. 2  
105005 Moscow, Russia  
Tel +7 - 495 730 78 00  
Fax +7 - 495 730 78 01  
E-mail: service@loewe-cis.ru

**S** Kjaerulff 1 AB  
Ridbanegatan 4, Box 9076  
200 39 Malmö, Sverige  
Tel +46 - 4 06 79 74 00  
Fax +46 - 4 06 79 74 01  
E-mail: loewe@loewe.se

**SG** Atlas Sound & Vision Pte Ltd  
10 Winstedt Road #01-18  
Singapore 227977  
Tel +65 - 6334 9320  
Fax +65 - 6339 1615  
E-mail: michael.tien@atlas-sv.com

**SLO** JADRAN d.d., Sežana  
Partizanska cesta 69  
6210 Sežana, Slovenija  
Tel +386 57391200  
Fax +386 57391460  
E-mail: info@jadrans.si

**SK** BaSys SK, s.r.o.  
Stará Vajnorská 37/C  
83104 Bratislava, Slovakia  
Tel +421 2 49 10 66 18  
Fax +421 2 49 10 66 33  
E-mail: loewe@basys.sk

**TR** SERVISPLUS GENEL MERKEZ  
ÖRNEK MAH. ATES SOK. NO:1  
34704 ATASEHIR, ISTANBUL, TÜRKIYE  
Tel +90 - 216 315 39 00  
Fax +90 - 216 315 49 50  
E-mail: info@servisplus.com.tr

**UAE** Dubai Audio Center  
P.O. Box 32836, Sheikh Zayed Road  
Dubai, UAE  
Tel +971 - 4 343 14 41  
Fax +971 - 4 343 77 48  
E-mail: service@dubaiaudio.com

**ZA** The Soundlab (Pty) Ltd  
P.O. Box 31952, Kyalami 1684  
Gauteng, Republic of South Africa  
Tel +27 - 1 14 66 47 00  
Fax +27 - 1 14 66 42 85  
E-mail: loewe@mad.co.za



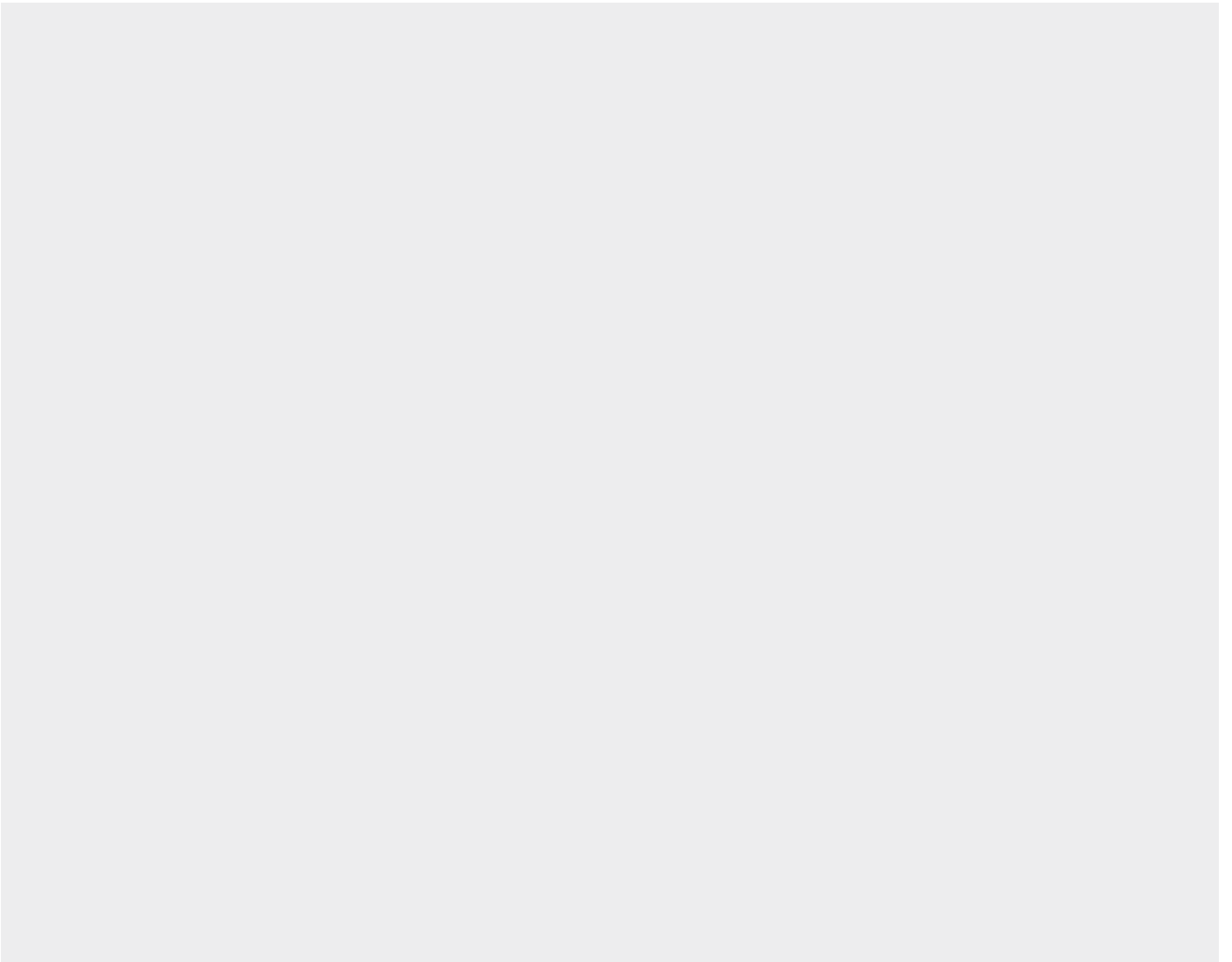

**LOEWE.**