One

TV

One 55



LOEWE

36598021



User manual

LOEWE.

Imprint

Loewe Technologies GmbH
Industriestraße 11
D-96317 Kronach
www.loewe.tv

Editorial date 11/16-3.0 TB/PS
© Loewe Technologies GmbH, Kronach
ID: 3.0.30.0

All rights including translation, technical modifications and errors reserved.



| | | | |
|---|-----------|---|-----------|
| Imprint..... | 2 | Video..... | 55 |
| Welcome..... | 5 | Video playback..... | 56 |
| Scope of delivery | 5 | Additional functions for DR+ archive playback | 59 |
| About this user manual | 5 | Audio/Radio | 62 |
| For your safety..... | 6 | Audio playback | 63 |
| Remote control button mapping..... | 8 | Radio mode (DVB radio) | 65 |
| Operating controls on the TV set..... | 9 | Radio mode (Internet radio) | 66 |
| Connections rear side of the device | 10 | Photo | 67 |
| Mounting on the table stand | 11 | Photo display..... | 68 |
| Mounting on the table stand | 11 | Web | 69 |
| Cable fixing | 11 | MediaNet..... | 69 |
| Preparing the TV set..... | 12 | Browser..... | 71 |
| Installing the TV set..... | 12 | System settings | 72 |
| Connecting the TV set..... | 12 | Picture | 73 |
| Preparing the remote control unit..... | 13 | Sound..... | 75 |
| Switching the TV set ON/OFF | 14 | Stations..... | 76 |
| General information on menu operation..... | 15 | Automatic scan TV+Radio | 77 |
| On-screen displays..... | 18 | Manual Scan TV / Radio..... | 78 |
| Explanation of keys..... | 18 | Station lists TV / Radio | 80 |
| Explanation of symbols | 18 | Compose / edit Personal list..... | 81 |
| Automatic menu info | 18 | Update station list automatically | 82 |
| Permanent clock display | 18 | Transfer all station lists | 82 |
| Operation without remote control | 18 | Control | 83 |
| Initial installation..... | 19 | Language | 84 |
| Initial installation wizard | 19 | EPG..... | 84 |
| TV set as a monitor | 30 | Parental lock | 85 |
| Home view..... | 31 | Energy efficiency..... | 86 |
| Home view - Favourites | 31 | Quick start mode..... | 86 |
| Home view - Sources | 31 | Software update..... | 87 |
| TV..... | 32 | On-screen displays..... | 92 |
| Setting the volume | 32 | Time and date | 92 |
| Select station | 32 | DVB settings..... | 93 |
| Status display..... | 34 | PIP..... | 93 |
| Function list (TV mode) | 35 | DR+ | 94 |
| AV list (AV Source)..... | 35 | Standard Teletext..... | 95 |
| Electronic Programme Guide – EPG..... | 36 | HbbTV | 96 |
| Teletext..... | 39 | Hard disks | 96 |
| HbbTV / MediaText..... | 41 | Export log file | 97 |
| Picture in Picture (PIP)..... | 42 | WEB key function..... | 97 |
| Digital Recorder | 43 | Multimedia / Network..... | 98 |
| TV viewing with time shift..... | 43 | Network settings..... | 98 |
| Archive recording..... | 44 | Multimedia settings..... | 101 |
| DR+ archive | 46 | Renderer | 101 |
| DR+ Streaming | 50 | Connections..... | 102 |
| Follow-Me function | 50 | Sound components | 103 |
| Timer | 51 | Antenna DVB | 106 |
| | | AV connection settings | 106 |
| | | Digital Link..... | 107 |
| | | Gaming mode | 107 |
| | | Extras | 108 |
| | | Integrated features | 109 |
| | | Reset to factory settings..... | 109 |
| | | Conditional Access module (CA module)..... | 110 |

| | |
|--|------------|
| External devices | 112 |
| Devices to the HDMI connections..... | 112 |
| Digital Link HD..... | 113 |
| Devices on AV..... | 114 |
| Connecting the speaker system (AUDIO OUT)..... | 116 |
| Connecting the HiFi/AV amplifier..... | 116 |
| Audio playback from external devices..... | 117 |
| Setting the remote control | 118 |
| Teaching the remote control | 119 |
| Troubleshooting | 121 |
| Technical Data | 123 |
| Signals via AV (PC IN) / HDMI..... | 124 |
| Signal input groups | 124 |
| Accessories..... | 125 |
| Upgrade kits / conversion kits / cables | 125 |
| Mounting options | 126 |
| VESA standard..... | 127 |
| Environment | 128 |
| Legal information..... | 128 |
| Miscellaneous..... | 129 |
| CA module error codes | 129 |
| Glossary | 130 |
| EC Declaration of Conformity..... | 133 |
| Index | 134 |
| Service..... | 138 |
| Code page | 139 |
| Notes | 141 |

Thank you,

for choosing a Loewe product and having placed your trust in us.

With Loewe you have not simply decided on a modern and technically innovative TV set, but for timeless design, sharp picture quality, brilliant sound for movies and music as well as intuitive operation with the Loewe remote control unit, smart phone or tablet. In short, Loewe is perfect for home entertainment – Made in Germany.

We look forward to welcome you as our customer and hope that you enjoy your Premium Home Entertainment made by Loewe.

Many features, one result: perfect Home Entertainment.



Just more entertainment.

The Loewe Assist Media user interface is intuitive and graphically optimised. This is how you quickly find your desired content – from TV set to online.
In the user guide refer to Home view.



Perfectly networked.

Thanks to its numerous connections, your Loewe TV becomes your entertainment centre. Connect it to the Internet, DVD/Blu-ray player, external speakers, etc.
In the user guide refer to Media+



Hard disk for your TV archive.

Record the TV programme on an externally connected hard disk or pause it and continue watching it at a later date. With DR+ (Digital Recording), all this is no problem for your Loewe TV set.
In the user guide refer to Digital Recorder.



Your contact person.

We are happy to help you with any questions regarding your TV set and other Loewe products.
In the user guide refer to Service.

Scope of delivery

- LCD TV set
- Antenna cable
- Remote control Assist with two batteries
- Attache-câble à velcro
- Installation instructions
- Table Stand
- Tool kit for mounting the set-up solution

About this user manual

For best results regarding safety and the longevity of the set, we recommend you read the chapter **For your safety** before switching the TV set on for the first time.

The chapter **glossary** gives explanations of certain terms used in the TV set and the user manual.

Paragraphs which begin with the symbol **I** indicate important instructions, tips or conditions for the following settings.

Terms which you will find in the menus or printed on the remote control or TV set are written in **bold** type.

The necessary control elements are shown in the descriptions to the left of the text containing the instructions for action.

Depending on the connected accessory equipment the menus in the TV set can differ from those described here.

All the station names, programme contents, the illustrated photos, titles, albums and album covers in this user manual are examples.

In addition to the remote control, a PC keyboard can be connected to one of the USB ports on your TV and then used to control your TV set.



In the user manual, this symbol indicates places in which the use of a keyboard is particularly advantageous.

The user manual for your TV set are updated at irregular intervals. We recommend an occasional examination on the Support Portal of the Loewe homepage.

General information on the operation of the TV set

For further information on the user interface and the general operation of your TV set see chapter **General information on the operation**.

Interactive data services

In some countries the stations also broadcast interactive data services with their programmes, leading to the functions of individual keys not being available or only so to a limited extent. You can find out more about this in chapter **TV**, section **HbbTV / MediaText**.

Important information

Loewe does not accept any liability for the nature and content of receivable Internet services. This also applies to the Loewe MediaNet portal. With its devices, Loewe provides the technical platform that fundamentally enables such material to be received. Loewe cannot make any guarantees regarding changes in scope and content, particularly with regard to the future and after going to press. The receivable online services are not included in the delivery and can vary depending on the product and country.

For your safety, and to avoid unnecessary damage to your unit, please read and follow the safety instructions below:

Intended use and ambient conditions

This TV set is intended exclusively for receiving and playing visual and audio signals. The TV set is designed for dry rooms (living rooms and offices). It must not be operated in rooms with high humidity (for example bathroom, sauna).

Please note that our TV sets are sensitive to dust and sooty particles in the ambient air. Excessive environmental pollutions of this kind can lead to damage of the device up to a malfunction. Pay attention to a clean ambient air, so that your device is not damaged.

Behind the panel plate of the LCD TV set, soot and dust deposits may appear without a soot generating source being visibly present. Such soot and dust deposits are also referred to as „fogging“ or „magic dust“. This phenomenon occurs sporadically, but in particular during the heating period and after renovations and in new buildings. As a cause for this, various factors are mentioned, see also reports on the Internet.

The cleaning or replacement of the panel is excluded from the warranty claims in such cases, because it is not a defect of the device, but an external influence.

If the unit is used outdoors, make sure that it is protected from moisture (rain, dripping water and splashing water or dew). High humidity and dust concentrations lead to leakage currents in the device. This can result in a shock hazard when touching it or even fire.

If you have moved the unit out of the cold into a warm environment, leave it switched off for about an hour to avoid the formation of condensation.



Do not place objects containing liquids on top of the unit. Protect the appliance against dripping and splashing water.

Candles or naked flames must be kept away from the TV set at all times to prevent it from catching fire.

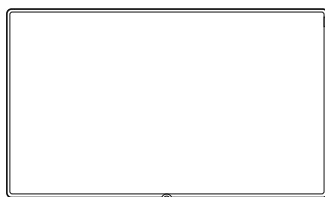

Never place the TV set in a location where it is exposed to vibrations. This may lead to damage.

Transporting

Move the device in vertical position only. Get hold of the device on the upper and lower edges of the housing.

Do not stand it up on the bottom edge, so as to reduce the risk of damage and soiling. If the set has to be put down during packing/unpacking, place the TV set with its entire front surface lying flat on soft material. Use a blanket or the fleece from the packing material as an underlay.

The LCD screen is made of glass or plastic and can break if not handled properly.

Always wear rubber gloves to carry the TV set if the LCD screen is damaged and liquid crystal might be leaking out. In the case of skin contact immediately rinse thoroughly with water.

Power supply

Incorrect voltages can damage the unit. This device may only be connected to a power supply with the voltage and frequency indicated on the type plate and using the supplied mains cable. The mains plug of the TV set must be easily accessible so that the device can be disconnected from the mains at any time. When unplugging the unit from the mains, pull at the connector body and not at the cable. The cables in the mains plug could otherwise be damaged and could cause a short-circuit when plugged in again.

Lay the mains cable so that it cannot be damaged. Do not step on the mains cable. The mains cable may not be kinked or laid over sharp edges nor be exposed to chemicals; the latter also applies to the unit as a whole. A mains cable with damaged insulation can cause electric shocks and poses a fire risk.

Air circulation and high temperatures

The vent slots on the rear panel of the set must always be kept unobstructed. Please do not place newspapers or cloths on/over the TV set.

Make sure that there is at least 10 cm free space on the sides and above the set for air circulation, if the set is placed in a cabinet or on a shelf.

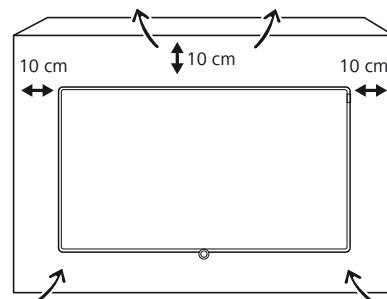

Like any electronic device, your TV set requires air for cooling. Obstruction of the air circulation can cause fires.

Prevent metal items, needles, paper clips, liquids, wax, or similar items, from getting into the interior of the device through the vent slots in the rear panel. Such objects can cause short circuits in the set, which could possibly cause a fire.

If something should get into the interior of the set then immediately unplug the mains plug of the device and contact the field service for more information.

About the LCD screen

The TV set with LCD screen you have purchased satisfies the most rigorous quality requirements and has been inspected with respect to pixel errors. Despite of thorough care when manufacturing the display, it cannot be 100% guaranteed that no subpixel defects will occur due to technical reasons. Please understand that these types of effects, as long as they are within the limits specified in the standard, cannot be considered as a device defect in terms of the guarantee.

Avoid displaying still images for long periods of time. It is possible that a copy of the image may remain visible.

Set-up

Loewe flatscreen TV sets are specified for Loewe accessories. The TV set is suitable for mounting in many different ways. Note the assembly instructions regarding the different possible mounting options.

When using accessories from other manufacturers take care that the TV set can be easily inclined or rotated on the respective mounting option.

For mounting options from other manufacturers with motor drive, make sure that the TV set cannot be rotated manually. The use of mounting options from other manufacturers with locks in certain positions is generally discouraged.

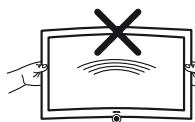

When rotating the TV set it is essential to ensure that the pressure exerted on the device frame is not too large. Especially in case of large-format displays there is a risk to damage the screen.

Before setting up the device, please check that the final location is suitable to bear the load of the device in terms of surface (sensitivity to pressure) and stability (statics).

This is particularly the case for the high-gloss painted surfaces and surfaces that are made from real wood / real wood veneer or plastic surfaces.

Place the TV set with the table or floor stand only on a level, sturdy, horizontal base. Particularly ensure that the set does not protrude to the front when placed in or on pieces of furniture.

Place the TV set in a normal position for use. TV set may only be used in an upright horizontal position. It may not be tilted by more than 10 degrees. The TV set must never be operated in portrait position, lying flat or hanging overhead from the ceiling.

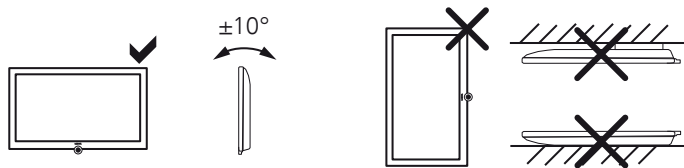

Set up the device where it is not exposed to direct insolation and where it is not exposed to additional heating by radiators.

When using the VESA mounting points, please refer to the information in chapter **Accessories**, section **VESA standard**.

Supervision

Do not let children operate the TV set unsupervised and do not let them loiter and play close to the set. The set could tip over, be pushed off or pulled down from the stand surface and injure someone.

Do not allow the switched-on TV set to run unattended.

Volume

Loud music can lead to ear damage. Avoid extreme volume especially over long periods and when using headphones.

Thunder storms

Pull out the mains plug and all connected antenna cables from the TV set in a thunderstorm. Overvoltage caused by lightning strokes can damage the set via the antenna system, as well as via the mains. The mains plug and all connected antenna cables should also be pulled out during long periods of absence.

Automatic shutdown

If the TV is not operated for 4 hours (adjustment of volume, programme change, etc.) the TV will automatically switch to stand-by mode to save energy. A prompt to terminate this shutdown process appears one minute before expiry of the 4 hours.

The automatic shutdown is active in the energy efficiency mode **Home Mode**.

Automatic shutdown does not occur when using the radio without screen display (screen off).

Cleaning and care

i Switch off the TV set with the main switch prior to cleaning.

Clean the TV set, the screen, and the remote control unit with a soft, moist, clean and colour-neutral cloth only, without any aggressive or scouring cleaning agents.

Repairs and accessories

Never remove the back of the TV set yourself. Have your TV set repaired or serviced by authorised television technicians only.

Only use original accessories such as Loewe stands, if possible.

Remote control button mapping

Depending on the selected operating mode (TV/Video/Audio/Photo/Web) and function (e.g. DR+, EPG, PIP, Teletext, HbbTV, etc.), the key assignment may differ from the assignment described here (see the corresponding chapter in this user manual).

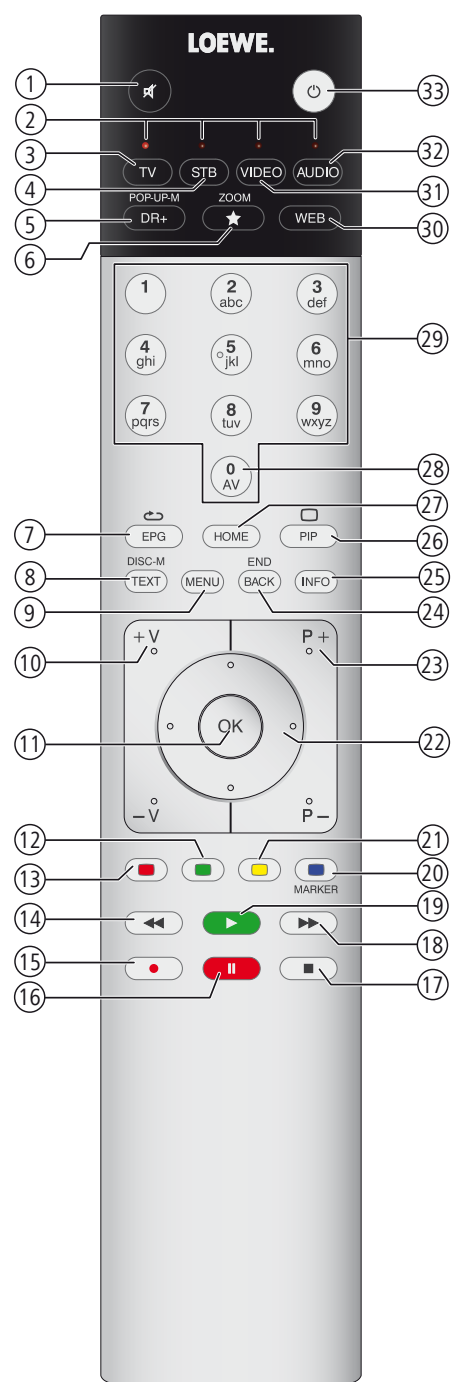

- ① Sound mute/on.
- ② LED display for currently operated device.
- ③ Call the TV mode.
- ④ Reassign remote control to SetTop-Box⁽¹⁾ (presetting: Apple TV).
- ⑤ Pressing briefly: Open the DR+ archive.
Pressing longer: Call timer list.
- ⑥ Add current object to Home favourites.
- ⑦ EPG (Electronic Programme Guide) on/off.
- ⑧ Teletext/MediaText⁽³⁾ on/off.
- ⑨ Pressing briefly: Call function list for the active operating mode.
Pressing longer: Call System settings.
- ⑩ **V+ / V-** increase/reduce volume.
- ⑪ Pressing briefly: Call station list.
Pressing longer: Call expanded station list.
In the menu: confirm/call up.
- ⑫ Green coloured key: screen on/off in Audio/Radio mode.
- ⑬ Red coloured key: call preferred value-added network service, if available⁽³⁾.
- ⑭ Pressing briefly: skip backwards.
Pressing longer: winding backwards.
- ⑮ Pressing briefly: direct recording (with determination of recording duration)⁽⁴⁾.
Pressing longer: One Touch Recording⁽⁴⁾.
- ⑯ Pause / Start/pause the timeshift television⁽⁴⁾.
- ⑰ Stop / End timeshift (return to live image)⁽⁴⁾.
- ⑱ Pressing briefly: skip forwards.
Pressing longer: winding forwards.
- ⑲ Play / Start/continue timeshift television⁽⁴⁾.
- ⑳ Blue coloured key: call station function list (selection of language/sound, subtitles or channel/video track).
- ㉑ Pressing briefly: Yellow coloured key: call history.
Pressing longer: Yellow coloured key: call last station.
- ㉒ Navigation on the user interface, select objects.
In the menu / lists: select/set.
- ㉓ **P+ / P-** next/previous station.
- ㉔ Pressing briefly: step / level back.
Pressing long: close all displays.
- ㉕ Press briefly during an on-screen display: info display. Info text appropriate to the content that can assist you further, should you have any questions about your TV set.
Press briefly, without on-screen display: access status display. With status display open and repeatedly pressing the key call the detailed information on the broadcast.
Press longer: show Explanation of keys.
- ㉖ PIP (picture in picture) on/off.
- ㉗ Call up the Home view.
- ㉘ Call up the AV list.
- ㉙ Select stations with numeric buttons directly.
In the menu: enter numbers or letters.
- ㉚ Call MediaNet (standard assignment)⁽²⁾.
- ㉛ Reassign remote control to video device⁽¹⁾ (presetting: BluTech Vision 3D).
- ㉜ Call radio mode (standard assignment)⁽¹⁾.
- ㉝ Switches the TV set on (mains switch must be turned on) or switches to standby mode.
Press briefly while TV set is switched on: TV set and all CEC-enabled devices connected to the HDMI ports will be switched off to standby (System Standby).

⁽¹⁾ The assignment of these keys can be changed (see chapter **External devices**, section **Setting the remote control**).

⁽²⁾ The assignment of these keys can be changed (see chapter **System settings**, section **Control – Web key function**).

⁽³⁾ Depending on the corresponding settings (see chapter **System settings**, section **Control – HbbTV**).

⁽⁴⁾ Only with externally connected USB hard disk.

Functions of the operating elements

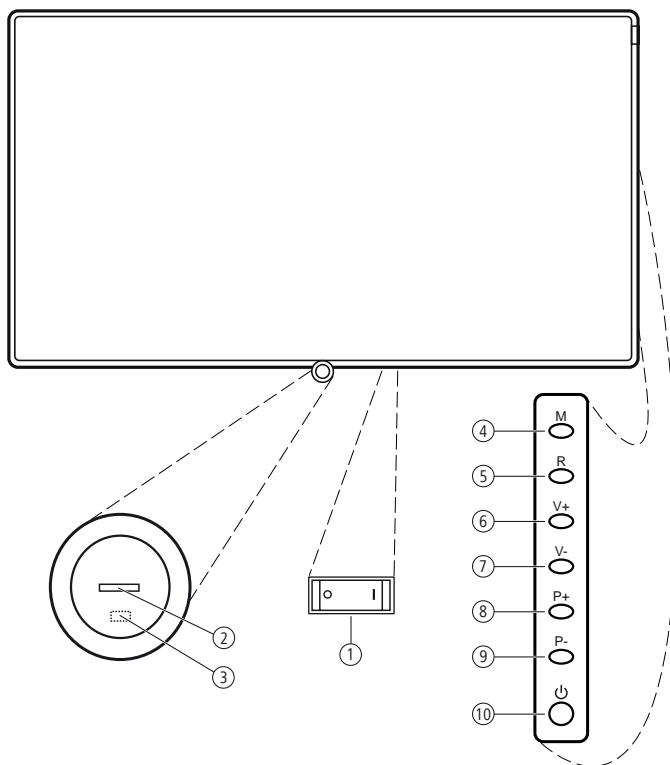





① Mains switch:

The mains switch is located on the bottom of the set.

Always return the TV set to Standby mode before switching it off with the main switch.

② Display:

| | | |
|---|----------------------|---|
|  | white: | TV set in standby. |
|  | white, intermittent: | TV set starts. |
|  | green: | TV set switched on. |
|  | red: | timer recording active. |
|  | blue: | TV set in standby and background operation active (EPG data updating, software update). |

③ IR receiver:

Infrared receiver for receiving the remote control commands.

④ Key M:

TV set in standby mode: switch TV set on in TV mode.
 TV set switched on: call direct control on TV set.
 Direct control on TV set: up ▲.

⑤ Key R:

TV set in standby mode: switch TV set on in radio mode.
 TV set switched on: toggle TV mode and radio mode.
 Direct control on TV set: down ▼.

⑥ V +:

TV set in standby mode: switch TV set on in TV mode.
 Increase volume.
 Direct control on TV set: to the right ►.

⑦ V -:

TV set in standby mode: switch TV set on in TV mode.
 Reduce volume.
 Direct control on TV set: to the left ◀.

⑧ P +:

Programme + (next station).

⑨ P -:

Programme - (previous station).

⑩ On/Off key:

Switching on from standby mode
 Switching off to the standby mode

Position and function of the connections

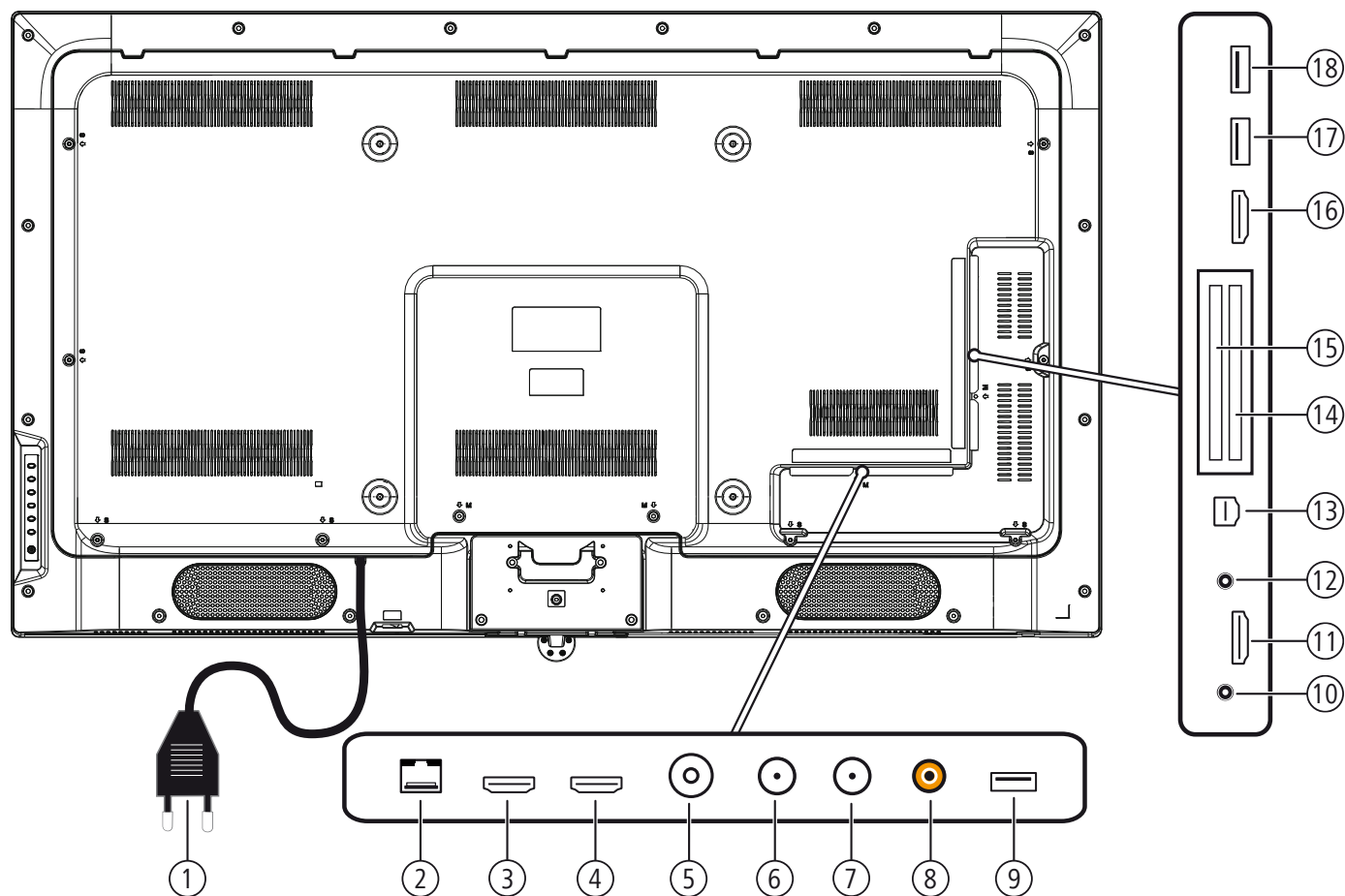

① **Mains connection**
 Power plug – 220-240 V - 50 / 60 Hz

② **LAN** - Network connection
 RJ-45 – Ethernet / Fast Ethernet

③ **HDMI 1 (ARC)** - HDMI input 1 (with **A**udio **R**eturn **C**hannel)
 HDMI – Digital Video IN (4K@60Hz)/Audio IN/OUT

④ **HDMI 2** - HDMI input 2
 HDMI – Digital Video IN (4K@60Hz)/Audio IN

⑤ **ANT TV** - Antenna/cable analogue / DVB-T/T2 / DVB-C
 IEC socket – 75 Ohm / 5 V / 80mA

⑥ **ANT SAT 1** - Satellite antenna (Sat tuner 1) DVB-S/S2
 F socket – 75 Ohm / 13/18 V / 500mA

⑦ **ANT SAT 2** - Satellite antenna (Sat tuner 2) DVB-S/S2
 F socket – 75 Ohm / 13/18 V / 500mA

⑧ **SPDIF OUT** - Audio output (digital)
 Cinch socket (orange)

⑨ **USB 3.0** - USB connection
 USB type A – USB 3.0 (max. 1000mA)

⑩ **HEADPHONE** - Headphone connection
 Jack 3,5 mm – Headphones 32–200 Ohm

⑪ **HDMI 3** - HDMI input 3
 HDMI – Digital Video IN (4K@60Hz)/Audio IN

⑫ **AUDIO OUT** - Audio output (analogue) L/R – (Jack 3,5 mm)

⑬ **AV INPUT** - Micro AV socket [†]
 Audio/Video IN with Scart adapter: Y/C (S-VHS/Hi 8)
 CVBS (VHS/8 mm)
 RGB
 L/R
 Audio/Video IN with VGA adapter: PC/STB video signal
 Component (YPbPr)
 L/R

⑭ **COMMON INTERFACE** - CI slot 1 (standard V1.3)

⑮ **COMMON INTERFACE** - CI slot 2 (standard V1.3)

⑯ **HDMI 4 (UHD)** - HDMI input 4
 HDMI – Digital Video IN (4K@60Hz)/Audio IN

⑰ **USB** - USB connection
 USB type A – USB 2.0 (max. 500mA)

⑱ **USB** - USB connection
 USB type A – USB 2.0 (max. 500mA)

[†] The adaptor is available as an accessory from your dealer.

Mounting on the table stand

For mounting the TV set on the table stand use the tool supplied (Torx T20, Allen key SW3).

Make sure during the mounting that the TV set and table stand are not scratched or damaged.

Follow the safety instructions when mounting in chapter **For your safety**.

Delivery specification of the table stand:

- (A) Table stand rotation unit with mounted cover (X)
- (B) Table stand plate
- (C) M5x16 screws (4 items)
- (D) M4x12 screws (4 items)

Step 1: Checking the rotation unit cover

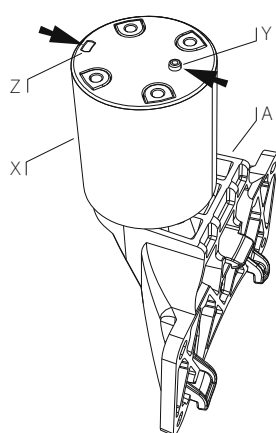

Please check whether the cylindrical cover (X) of rotation unit (A) is placed in the correct position.

The pin (Y) and the centre hole (Z) must be positioned as shown in the adjacent figure. In this case, you can proceed with the assembly.

Should this not be the case, please pull off the cover (X) from the rotation unit (A), and plug it into the correct position again.

Step 2: Assembly of the rotation unit

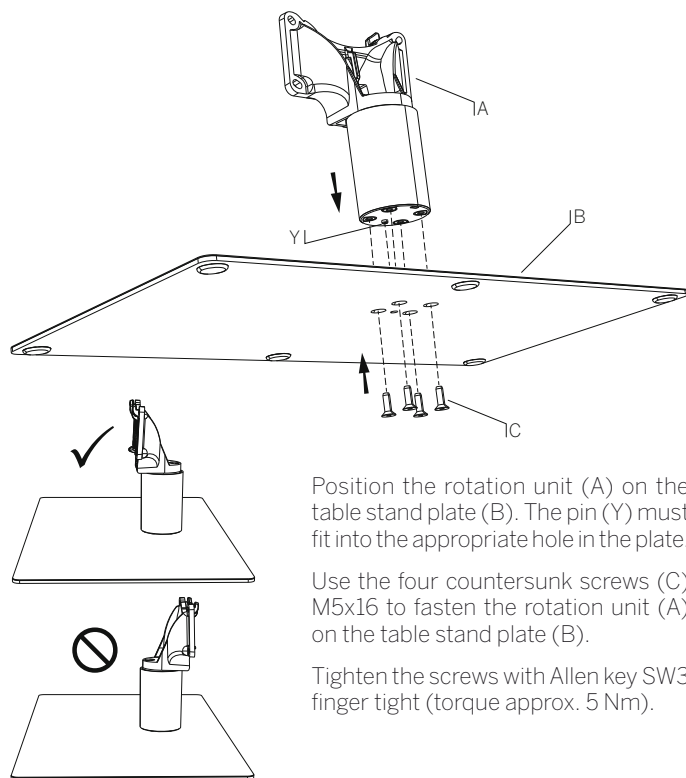

Position the rotation unit (A) on the table stand plate (B). The pin (Y) must fit into the appropriate hole in the plate.

Use the four countersunk screws (C) M5x16 to fasten the rotation unit (A) on the table stand plate (B).

Tighten the screws with Allen key SW3 finger tight (torque approx. 5 Nm).

Step 3: Positioning of the TV set

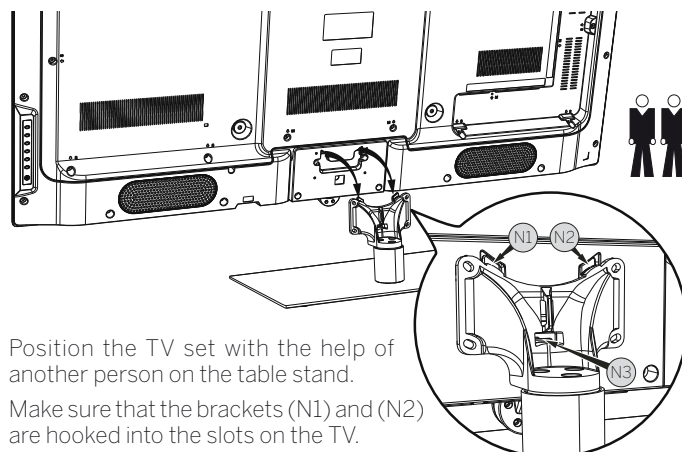

Position the TV set with the help of another person on the table stand.

Make sure that the brackets (N1) and (N2) are hooked into the slots on the TV.

Then apply slight pressure to click bracket (N3) into place.

Step 4: Aligning and mounting the TV set

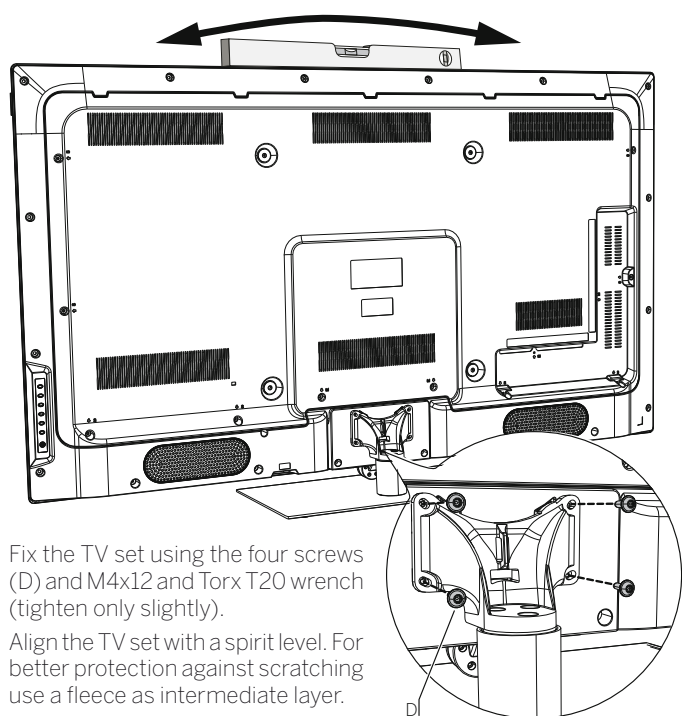

Fix the TV set using the four screws (D) and M4x12 and Torx T20 wrench (tighten only slightly).

Align the TV set with a spirit level. For better protection against scratching use a fleece as intermediate layer.

Then tighten the four screws (D). Torque approx. 2 Nm (tighten hand-tight).

Cable fixing

Using the Velcro cable tie supplied, you can fix the rear cables.

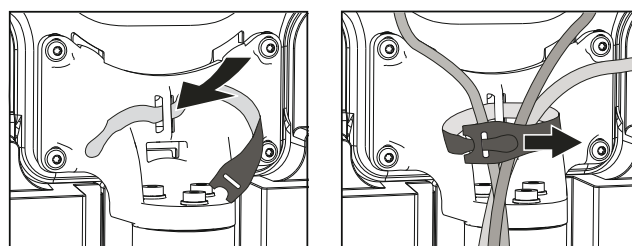

Installing the TV set

Choose a place for installing your TV set where no bright light or sunlight shines directly onto the screen. This could cause reflections which impair the picture.

3 times the screen diagonal can be taken as a guide value for the viewing distance (e.g., for a 55-inch set approx. 4,2 m for SD signal). The viewing distance can be reduced with an HD/UHD signal.

Connecting the TV set

Connecting to the mains supply

Connect the TV set to a 220-240V mains socket:

Connect the plug of the power cord fixed to the TV set with a mains socket.

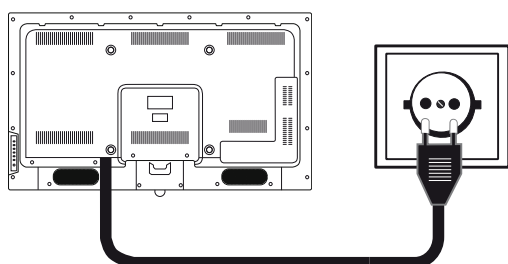

Connecting antennas

Cable (analogue) / DVB-C / DVB-T antenna:

Plug the cable of antenna, cable TV system or room antenna into the **ANT TV** socket.

If you want to use analogue cables / DVB-C connection and a DVB-T antenna together, use an external antenna switch (available from your dealer).

Satellite antenna DVB-S:

Depending on the used satellite system, connect a connecting cable from the multi-switch or directly from the LNC to the **ANT-SAT** and **ANT-SAT2** sockets of the TV set respectively.

When connecting the TV set to a single cable community antenna, connect the **ANT-SAT** and **ANT-SAT2** sockets directly to the appropriate SAT antenna socket.

When connecting the TV set to a **DiSEqC single cable community antenna** (in accordance with EN 50494), connect the **ANT-SAT** socket directly to the appropriate SAT antenna socket.

I In case of a DiSEqC one cable communal system you require only **one** antenna cable. Further distribution of the signal to the two reception routes is accomplished by the TV set's satellite tuner.

It is possible, however, to continue using an existing SAT cabling with two antenna cables in a DiSEqC one cable communal system. If two transmission channels of the DiSEqC single cable community exist, one system channel is used per satellite antenna cable (see also chapter **Initial installation**, section **DiSEqC single cable community antenna**).

Ask your dealer in this regard.

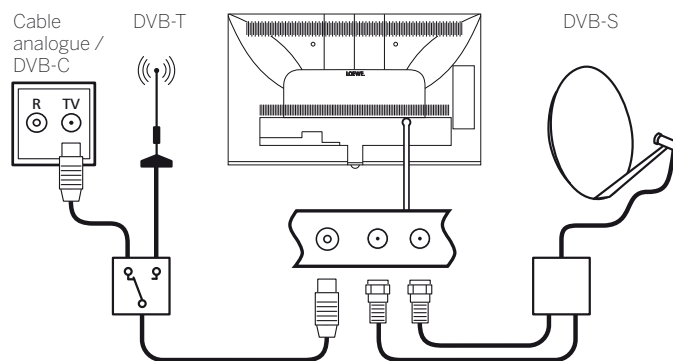

Connecting the TV set to the Home network

You may link your TV set to the home network by a **wired connection** (Ethernet, Powerline adapters separately available) or by a **wireless radio connection** (WLAN). For wireless connections, the TV set has an internal WLAN antenna.

In order to play back data from your home network your Loewe TV supports the UPnP AV standard.

For the network adaptor configuration, see chapter **System settings**, section **Multimedia / Network – Network settings**.

I Under no circumstances may the TV set be **wired** and at the same time connected by a **wireless connection** to the same network, e.g. router. This may cause severe operational faults!

Example for a wired connection

Connect the LAN socket of your TV set to the LAN switch/router of your home network with a network cable (available from your dealer).

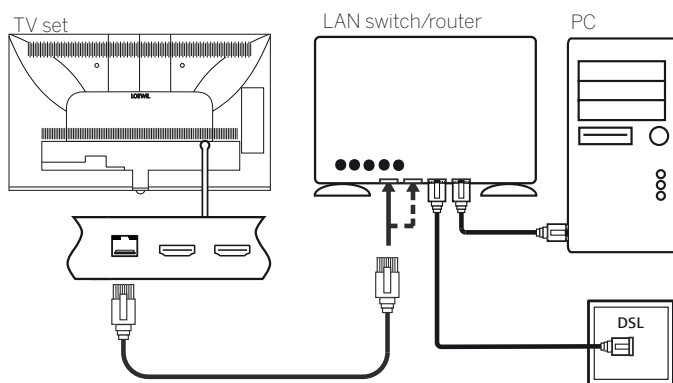

Example for a wireless connection

You can connect the TV set to your home network by a wireless radio connection via the WLAN antenna inside the set.

Shadow effects of various materials, such as reinforced concrete, metal surfaces, etc., attenuate the WIFI signal sometimes significantly or completely.

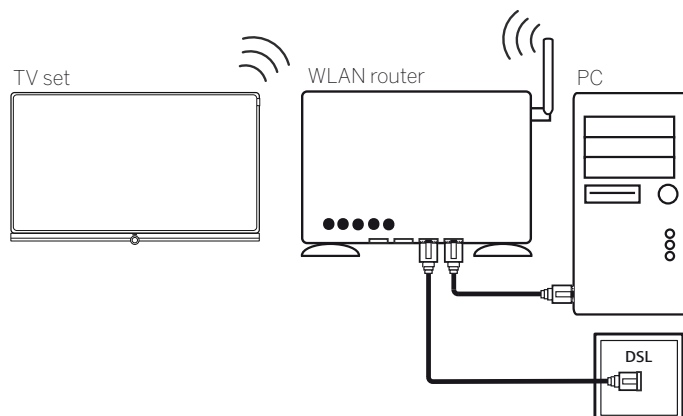

Help for configuration problems

Loewe cannot provide any support for PC hardware and software or network components owing to the diverse configuration options with home networks.

Please contact the administrator of your home network and/or specialist dealer for support when setting up and for maintenance of network connections, storage media, media server software and network devices such as routers.

Preparing the remote control unit

Inserting or replacing batteries

Press on the embossed arrow whilst pushing the battery cover down. Only use leak-proof micro-cells of the LR 03 (AAA) Alkali-Manganese type. Do not use different types of batteries and old and new batteries together.

The batteries used must not be exposed to excessive heat such as sunlight, fire or similar!

The position of the batteries is indicated in the battery compartment (in opposite directions). Pay attention to the correct polarity of + and - when inserting the batteries.



If the batteries are too weak after longer use, the TV set prompts you to change the batteries. Dispose of used batteries in an environmentally friendly way (see chapter **Environment / Legal information**).

Push the cover back on from below after having inserted the batteries.

Adjusting the remote control for operating the TV set



Press the **TV key**.

See in chapter **External devices**, section **Setting the remote control** how to operate other Loewe appliances and how to re-programme the remote control keys.

Switching the TV set ON/OFF

Switching TV set to the standby mode

Switch the mains switch on the bottom side of the device to position **I**.
 The indicator on the front side lights up white. The set is now in standby mode..

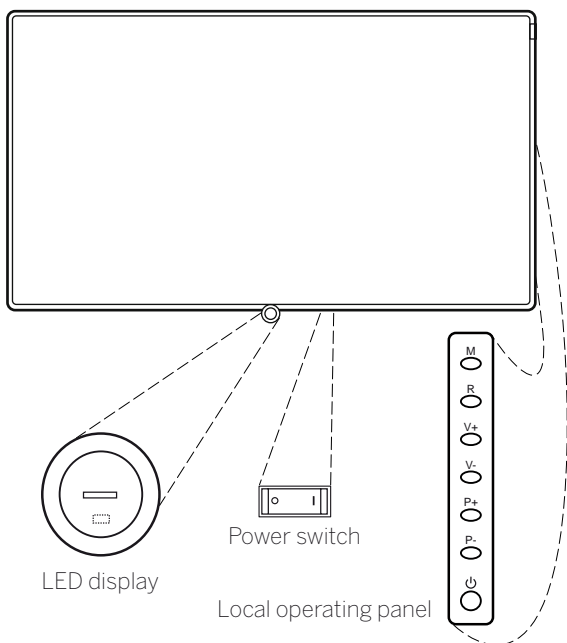





Switching the TV set on/off via the local operating panel



To switch the TV set into Operating mode or switch it off into Standby mode, press the button  on the local operating panel.

When pressing the buttons **M/V+/V-**, the device switches on in the previously used mode (TV/Radio), when pressing the button **R**, in the radio mode.

Meaning of the LED colours:

| | | |
|---|----------------------|---|
|  | white: | TV set in standby. |
|  | white, intermittent: | TV set starts. |
|  | green: | TV set switched on. |
|  | red: | timer recording active. |
|  | blue: | TV set in standby and background operation active (EPG data updating, software update). |

i After switching on the TV set, it takes a few seconds for further operating commands to be processed (Exception: Quick start mode, see chapter **System settings**, section **Control – Quick start mode**). Your TV set is ready for operation once the LED display lights green.

Switching the TV set on by means of the Remote control



Press the **on/off key**.

Or:



Press the **TV key**.

The previously watched station will be called.

Or:



Press **numerical keys 1-9**.

The corresponding station will be called.

i After switching on the TV set, it takes a few seconds for further operating commands to be processed (Exception: Quick Start Mode, see below). Your TV set is ready for operation once the LED display lights green.

Switching the set off with the remote control (Standby)



Press the **on/off key**.

i Before switching off the set with the mains switch, we recommend you to switch it to standby mode.

Switching off the TV set and connected additional devices (System standby)



Press **on/off key** long:

Switch TV set and all CEC-capable devices connected to the **HDMI** interfaces OFF to Standby mode (System Standby).

Technical information

Switching off the TV set with the mains switch during operation or an inadvertent disruption to the power supply (e.g. power failure) can cause damage to the hard disk file system of an externally connected hard disk and hence loss of the recorded broadcasts.

Before switching off the set with the mains switch, we recommend you to switch it to standby mode.

However, if unexpected problems occur when operating the hard disk, formatting the external hard disk may rectify this. Refer to the instructions in chapter **System settings**, section **Control – Hard disks**.

Loewe are not liable for the loss of data on the hard disk externally connected to your TV set. To avoid data loss, we recommend copying important recordings to an additional external storage medium.

General information on menu operation

The most important keys for navigation will be explained in general. The numbers in the text refer to the figure showing the remote control in chapter **Remote control**.

The **arrow keys** (22) help you to navigate in the menus and lists of the TV set and for selecting menu items. They are arranged in the middle of the remote control in a circle around the **OK** key (11). Later in this user manual they will be represented as follows:



The **OK** key (11) is used to confirm a selection, for calling the highlighted menu item and for opening the station list. In this user manual, an instruction for this key looks like the following:

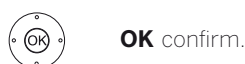

Using the **numerical keys** of your remote control (29) you enter programme channels and teletext pages directly. With key **0** you open the AV list. In this user guide, entering numbers with numerical keys is shown as follows:

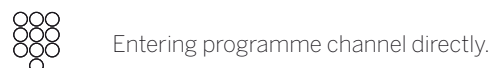

The numerical keys are also used to enter text (see chapter **General information on menu operation**, section **Entry of characters by remote control**).

The **Home** view is the central overview page for all of your TV set's operating modes. You reach **Home** view with the **HOME** key (27).



Pressing the **BACK** key (24) briefly brings you one level up in the wizard. Pressing the **BACK** key longer closes all opened fade-ins. An example for the **BACK** key in this user manual:



Pressing longer on the **INFO** key (25) displays an explanation of the most important key functions of the current operating mode (e.g. TV mode, teletext, PIP, etc.).

If the function for a key is not available, this will be indicated by an inserted symbol (no) on the right above.

Structure of the Menu screen

Basically, the structure of the different menu screens is similar, depending on the fact if a wizard, rendering media content or a setup menu are concerned. The structure is explained by means of three different illustrations.

Screen structure: Wizard

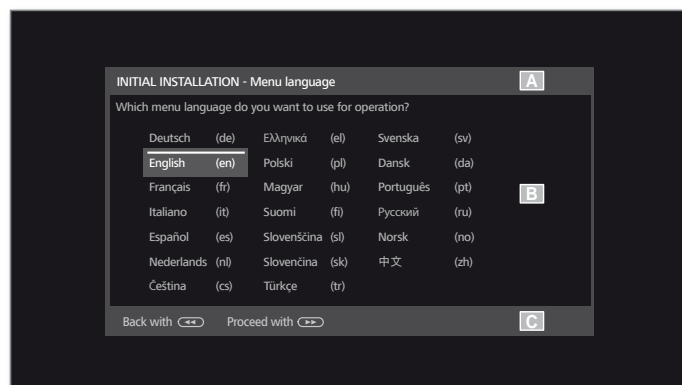

- (A) Title bar with name of the wizard and the current operating step.
- (B) Selected items, whose number can be different according to the operating step.
- (C) Bottom line showing the available operating controls. If required, instructions and information are inserted.

Screen structure: Rendering of media content (example: Audio player)

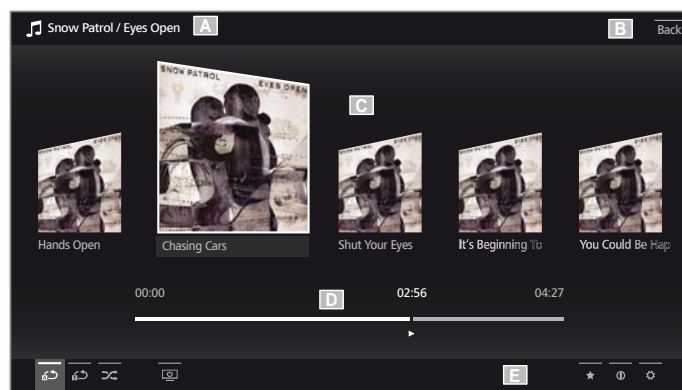

- (A) Title bar with selected album / subdirectory.
- (B) Menu item **Back** to exit the menu or to go back to the previous menu item.
- (C) Selection of album or title
- (D) Time bar
- (E) Bottom line with the different symbols for controlling the playback function.

Screen structure: Setup (example: picture)

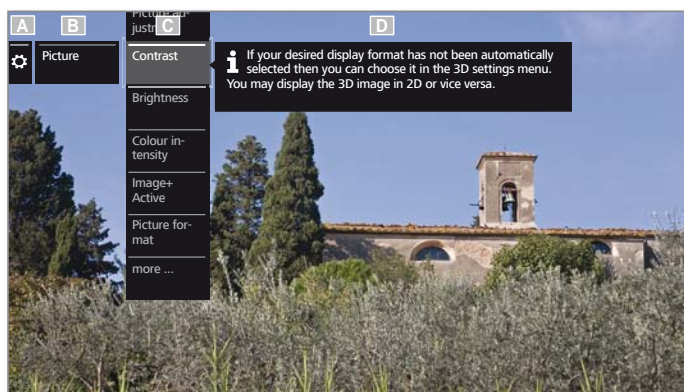

- (A) Selected function in the Home overview (here: system settings)
- (B) Home Menu **System settings**, with selected menu item **Picture**.
- (C) Menu items **Picture** focusing on **Contrast**.
- (D) Help text for the selected menu item **Picture > Contrast**.

Navigation: Selection of elements (example: On-screen displays)

Highlighting and thus selecting the symbols/elements or menu items on the screen can be effected by the arrow keys on the remote control. So you can see all the time where you are. As soon as there is a bar above a symbol or text, this is a selected element.

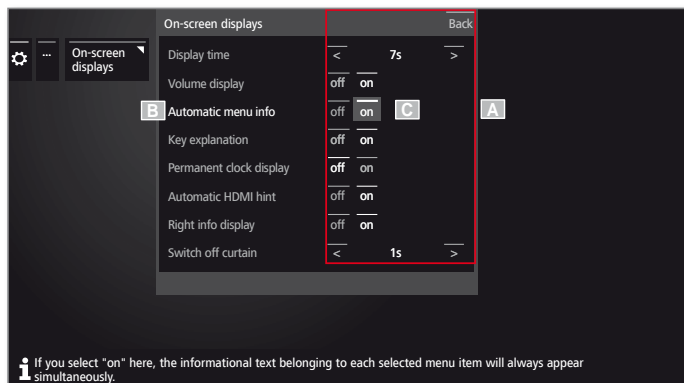

- (A) Selectable elements / menu items.
- (B) The text in the line where the marker is currently located is white.
- (C) Move the selection marking by means of the arrow keys ◀ ▶ ▲ ▼ to the menu item to be set. The position of the marking is to see by a grey rectangle.

In most cases, the marked menu item will be automatically adopted. The font colour of the previously active item will change to grey, that of the newly selected item to white.

i In a few menus, to confirm a selected menu item is required by pressing **OK**.

Navigation: Wizards

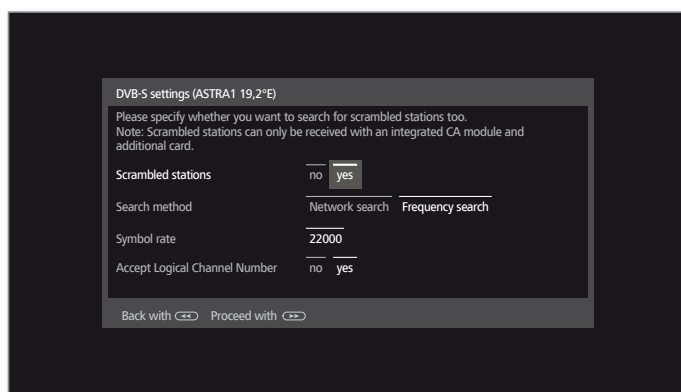

If the menu item(s) (marked white) is/are already correctly preset:



Go to next step.



Otherwise:

◀ ▶ ▲ ▼ Mark the menu item that you want to change. The update will be adopted automatically. The fount colour of the previously active item will change to grey. If not,

OK confirm the selection.



Go to next step.

Navigation: Element selection in lists using initials

Using the numerical keys of the remote control you can jump into list, e.g., Internet radio station lists.

If the list is sorted in **alphabetical** order, you jump to the entered letter. For example, when pressing the key **7** three times you jump to the first list element starting with letter **R**.

In case of **numerical** sorting, you can directly select the stations with the numerical keys.

Entering characters with on-screen keyboard

For certain functions, entering letters or characters is required, e.g., for Web addresses (URLs) in the browser or for renaming archive entries. An on-screen keyboard appears for entering text.

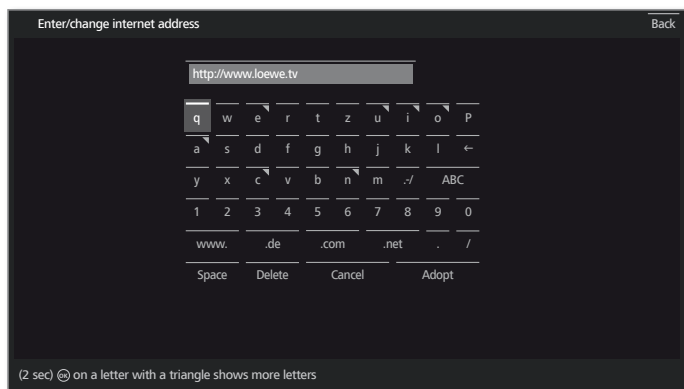

Table of characters for entering text by means of the remote control

| Key | Characters (uppercase - lowercase) |
|-----|---|
| 1 | [space] 1 |
| 2 | ABC2ÄÆÅÃÄÁČĀĀ - abc2äæãääááćč |
| 3 | DEF3ĔĚĒĒĔĔĔĔ - def3ėėēēēē |
| 4 | GHI4İİĲĲİİİ - ghi4ııĳııı |
| 5 | JKL5 - jkl5 |
| 6 | MNO6ÖOEÖÖÖÖÓØ - mno6ńñňöoeöóóóø |
| 7 | PQRS7ß - pqrß7ß |
| 8 | TUV8ÛŪŪŪŪŪ - tuv8üüüüü |
| 9 | WXYZ9 - wxyz9 |
| 0 | . 0 - / _ : + , ; ? ! = & # % ~ @ \$ * ' () " \$ \ { } [] < > ' ` ^ |



◀ ▶ ▲ ▼ Select character / on-screen button,
OK Adopt character.

In the event of letters with a triangular, additional letters are displayed when pressing the **OK** button longer (2 sec).
 For the selection of special characters use the **.-/** field.

To conclude the entry:

◀ ▶ ▲ ▼ Select **Adopt**,
OK confirm the selection.

Entry of characters by remote control

Alternatively to the on-screen keyboard you can also enter the desired characters by means of the remote control (as with the keypad of a mobile phone).



◀ ▶ ▲ ▼ Select text entry field.

Under the 1st letter of the name you will see a line indicating the current input position.

- ▶ Input position one character to the right (also for blanks).
- ◀ Input position one character to the left.



Input the letters one after another. When using the remote control, press the **numerical keys** just as on a mobile phone keypad (0-9) until the desired symbol is displayed. The available letters are printed on the individual numeric buttons.

You find the exact key assignment in the character table in the right column.

To conclude the entry:



◀ ▶ ▲ ▼ Select **Adopt**,
OK confirm the selection.

Explanation of keys

An explanation of the main operating keys that can be used at the moment, can be displayed.

The availability of the key explanation is dependent on the currently active operating situation.

INFO press longer: show Explanation of keys.



INFO **BACK** **INFO** or **BACK**: hide Explanation of keys.

Explanation of symbols

On screen pages with operating symbols in the bottom line, an explanation of the function appears as soon as the symbol is selected.

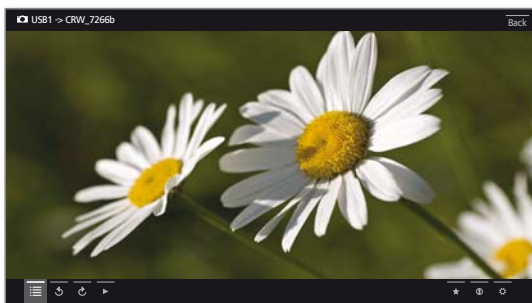

Automatic menu info

The automatic menu info provides an info text for the selected menu item appropriate to the on-screen display that can assist you further with the operation of your TV set.

i An on-screen display is displayed.

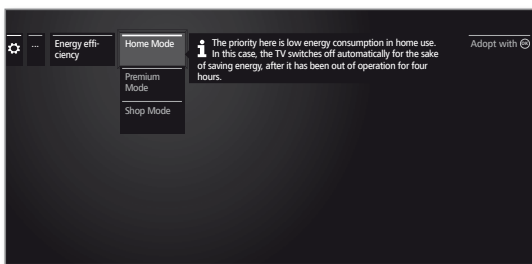

INFO The factory setting is that the info display is shown automatically for each menu item. In this case you can temporarily hide the info texts with the **INFO** key.

Permanent clock display

The clock display can be permanently shown. It is always visible as long as no other display is made.

You can switch the permanent clock display on or off in **Home view** under **System Settings** → **Control** → **more ...** → **On-screen displays**.

Operation without remote control

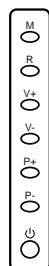

Changing Volume

+ / - Increase/reduce volume.

Select station

P+ / P- Next/previous station.

Switching radio on or off or switching to radio

R Radio on or switch between TV and Radio.

Calling direct control on TV set



M Call direct control on TV set.



R Scroll down.

M Scroll up.

V- Scroll left.

V+ Scroll right, adopt settings, confirm.

Close all displays

Press **M** longer.

Explanations of the settings:

- Operating mode Switch between TV and radio operation.
- Stations selection Call Station selection.
- AV selection Select AV interface.
- Contrast Set contrast.
The power consumption of the TV set depends directly on the value set here.
- Picture format Selecting the picture format.
- Service **i** The Service menu item is provided for service purposes by dealers only.

Initial installation wizard

Initial installation after switching on for the first time

The Initial installation wizard starts automatically with an initial installation. It may be called repeatedly again (see chapter **System settings**, section **Extras – Repeat initial installation**).

i If a parental lock is activated, the access code must be entered before repeating initial installation (see chapter **System settings**, section **Control – Parental lock**).

i For information on navigation within the wizard refer to chapter **General information on menu operation**.

First installation wizard routine

The selected settings affect the routine of the Initial installation wizard.

Menu language

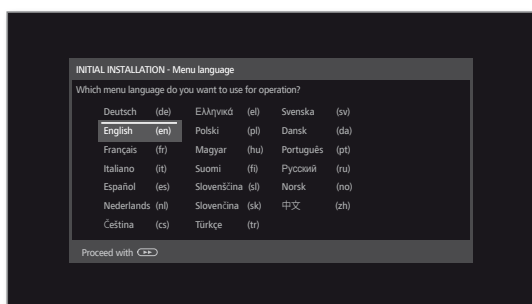

▲ ▼ ◀ ▶ Select desired **Menu language**.

Selecting the language of the user guidance is the wizard's first step. Then you simply follow the instructions on your TV screen.



▶▶ Proceed to next step.



A licence agreement will be displayed.

▲ ▼ Scroll through the licence agreement.

OK Confirm the licence agreement and proceed to the next step.

Energy efficiency

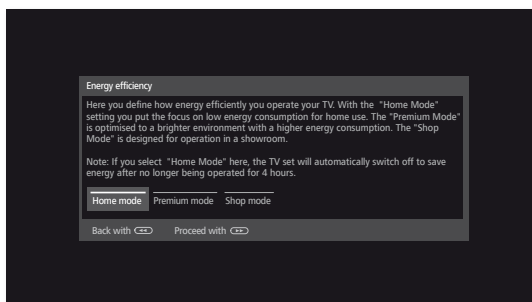

◀ ▶ Select **Energy efficiency**.

Determine how energy efficient your TV set shall be. The value for the contrast (and thus the brightness of the background lighting) is adapted and the automatic dimmer activated or deactivated depending on the presetting.

The automatic shutdown is active in the mode **Home Mode**.

Energy efficiency (continued)

Home mode:

The emphasis for home use is on low energy consumption. The automatic dimmer is activated.

Premium mode:

This mode optimises the settings to a brighter environment at a higher energy consumption. The automatic dimmer is activated.

The use of this energy efficiency setting must be confirmed afterwards once again.

Shop mode:

The picture settings are aligned to operation in the presentation room. The automatic dimmer is deactivated. If the ambient brightness diminishes, the energy consumption is not reduced.

The use of this energy efficiency setting must be confirmed afterwards once again.

i The presetting can be changed later in the **System settings** under **Control → Energy efficiency**.



▶▶ Proceed to next step.

Location of TV set

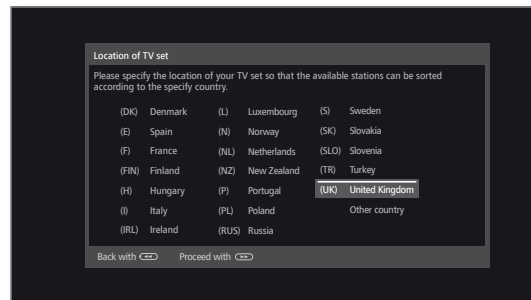

▲ ▼ ◀ ▶ Select **Location of TV set** (national defaults are adopted).

For certain locations (e.g., Australia), there is finally a selection screen where you can indicate in which state/territory the device is being operated.



▶▶ Proceed to next step.

Operating mode

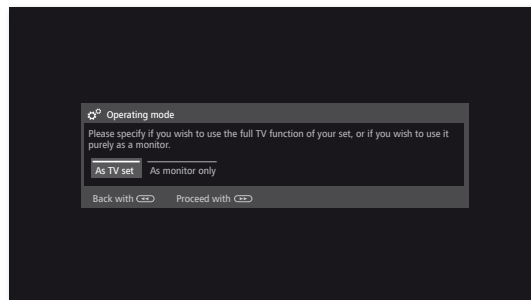

◀ ▶ Select the **Operating mode**.

Use the TV set as a **TV set**: Continued with **Connect antennas cable(s)** (see next page).

Use the TV set **just as a monitor**: see chapter **Initial installation**, section **TV set as a monitor**

Connect antennas cable(s)

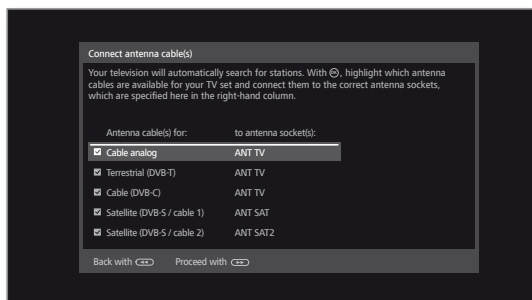

▲ ▼ Select antenna cable.
OK Connect/disconnect antenna cable.
 Select the antenna cables that are connected to your TV.
 Ahead of each selected antenna, the symbol appears.

- Cable analog:** analogue stations via cable
- Terrestrial (DVB-T):** digital stations via antenna
- Cable (DVB-C):** digital stations via cable
- Satellite (DVB-S/cable 1):** digital stations via satellite
- Satellite (DVB-S/cable 2):** digital stations via satellite



▶▶ Proceed to next step.

The rest of the initial installation wizard routine depends on the selected antennas (Cable analogue, DVB-T, DVB-C, DVB-S) in step **Connect antennas cable(s)**.

The different antennas/types of reception are described in the following sections of initial installation.

Setting options for reception via Cable analog:

If you have not selected **Cable analog** in step **Connect antenna cable(s)** in the initial installation, proceed to the next section **Setting options for DVB-T reception**.

TV/col. standard

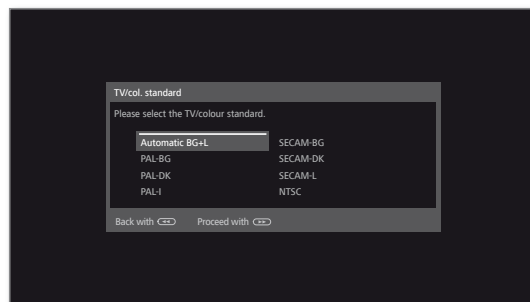

i The selection of a Colour standard is only required when the Location of TV set **Other country** was selected. Otherwise, the country-specific default settings will be preset when selecting the Location of TV set. This step will be skipped then



▲ ▼ ◀ ▶ Select appropriate colour standard.



▶▶ Proceed to next step.

Setting options for DVB-T reception:

If you have not selected **Terrestrial (DVB-T)** in step **Connect antenna cable(s)** in the initial installation, proceed to the next section **Setting options for DVB-C reception**.

Network selection

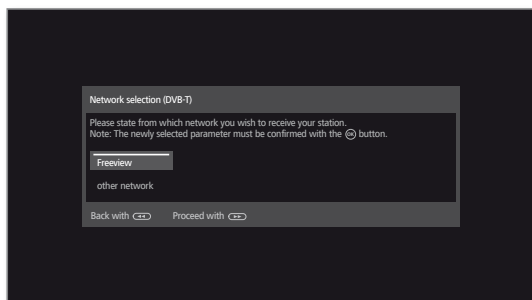

If several networks are available via DVB-T, you can decide which network you want to receive your channels from.



▲ ▼ Select network,
OK Confirm selection.



▶▶ Proceed to next step.

Settings

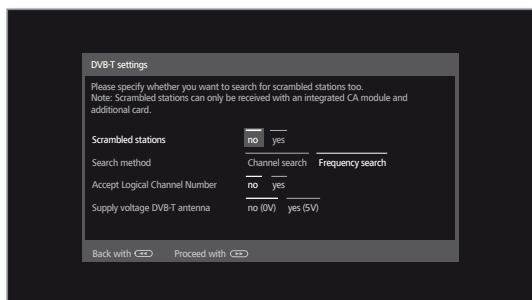

▲ ▼ ◀ ▶ Select and adapt settings for DVB-T reception.

Supply voltage DVB-T antenna Select supply voltage **no (0V) / yes (5V)**.

If you use a DVB-T antenna that requires a supply voltage (active antenna) and which is not already supplied via a power adaptor, then select **yes (5V)** for the antenna's power supply.

How to align your DVB-T antenna is described in chapter **System settings**, section **Connections – Antenna DVB**.



▶▶ Proceed to next step.

Scrambled stations You can state whether coded stations are to be searched for in the search/update. Select **yes** to save all found scrambled stations. However, these stations can only be received in connection with a CA module and the appropriate Smart Card.

The handling of the CA module is described in the chapter **System settings**, section **Extras – CA module**.

Search method If you want to run the station search independently of the channel grid, select **Frequency search** for the search method.

Accept Logical Channel Number In various countries, digital stations (DVB-T) are transmitted with a preset channel number per station, known as Logical Channel Numbers (LCN). If you select **yes** here, these default channel slots will be used and the channels of the preferred signal source will be sorted as per LCN. The stations in the station list can no longer be shifted.

Setting options for DVB-C reception:

If you have not selected **Cable (DVB-C)** in step **Connect antenna cable(s)** in the initial installation, proceed to the next section **Setting options for DVB-S reception**.

Network selection

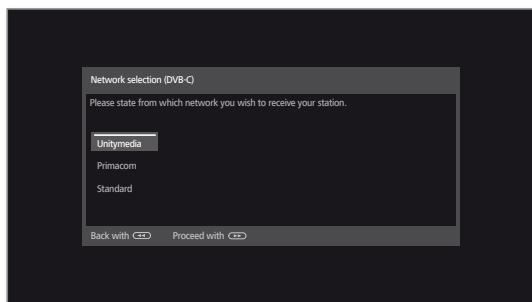

If several networks are available via DVB-C, you can decide which network you want to receive your channels from.

The normal DVB-C settings are derived from the selection of the location or network and do not need to be changed.

Exactly which of the following settings are present is dependent on which network is selected.



▲ ▼ Select network.
OK Confirm selection.



▶▶ Proceed to next step.

Settings

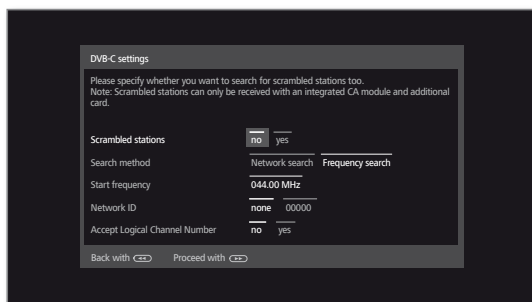

▲ ▼ ◀ ▶ Select and adapt settings for DVB-C reception.

Scrambled stations

You can state whether coded stations are to be searched for in the search/update.

Select **yes** to save all found scrambled stations. However, these stations can only be received in connection with a CA module and the appropriate Smart Card.

The handling of the CA module is described in the chapter **System settings**, section **Extras – CA module**.

Search method

If you select **Frequency search** here, a search is performed for all receivable stations.

With **Network search**, only the stations which the networks supply are searched - either for all receivable networks or only for the particular network specified under **Network ID**.

Start frequency

The DVB stations are only searched for in the frequency range above the start frequency.

Network ID If you select **none** here, DVB signals of all current transmitter networks are searched automatically (recommended for most cable networks).

If, on the other hand, you specify a certain network ID (necessary in the cable networks of some countries), only DVB signals of this broadcasting network are searched for automatically.

Your cable provider has the information you need.

Accept Logical Channel Number

In various countries, digital stations (DVB-C) are transmitted with a preset channel number per station, known as Logical Channel Numbers (LCN).

If you select **yes** here, these default channel slots will be used and the channels of the preferred signal source will be sorted as per LCN. The stations in the station list can no longer be shifted.



▶▶ Proceed to next step.

Setting options for DVB-S reception:

If you have not selected **Satellite (DVB-S/cable x)** in step **Connect antenna cable(s)** in the initial installation, proceed to the next section **Setting options for all types of reception.**

Network selection

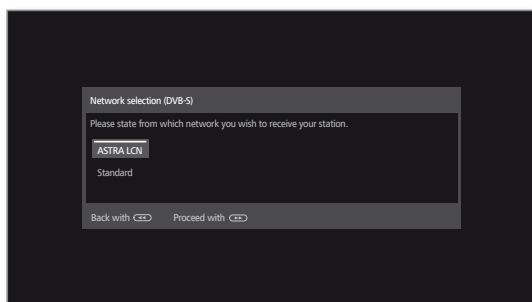

▲ ▼ Select network.
 If several networks are available via DVB-S, you can decide which network you want to receive your channels from.



▶▶ Proceed to next step.

Select satellite installation

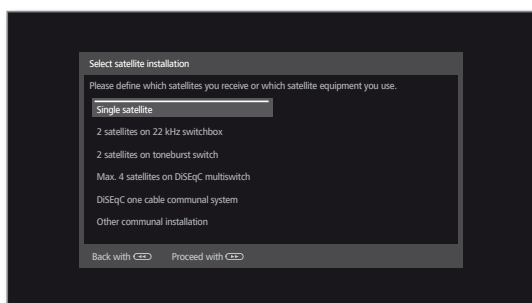

▲ ▼ Selecting the satellite system.
 Specify how you receive which satellite(s) (single satellite or type of satellite system). Ask your dealer in this regard.

The normal DVB-S settings are derived from the selection of the location and do not need to be changed in most cases.

other communal installation Select setting if the TV set is connected to a single-cable system (without DiSEqC). Several Sat receivers can be connected to one Sat cable. Contrary to a DiSEqC one cable communal system there are restrictions in the range of certain reception frequencies in "common" single-cable community systems.



▶▶ Proceed to next step.

The rest of the initial installation wizard routine depends on the selected satellite system in step **Select satellite installation.**

The different satellite systems are described in the following sections of initial installation.

Single satellite Reception of a single satellite via a connected LNC (LNB).

2 satellites on 22 kHz switchbox Reception of two different satellites with two LNCs (LNBs) which are connected to the TV set by a 22 kHz switchbox.

2 satellites on toneburst switch Reception of two different satellites with two LNCs (LNBs) which are connected to the TV set by a toneburst switch.

Max. 4 satellites on DiSEqC multiswitch The TV set controls a DiSEqC multiswitch to which up to four LNCs (LNBs) for different satellites are connected.

DiSEqC one cable communal system Select setting if the TV set is connected to a DiSEqC single-cable system (according to EN 50494). Several Sat receivers can be connected to one Sat cable.

Setting options for the satellite system (single satellite):

Select single satellite

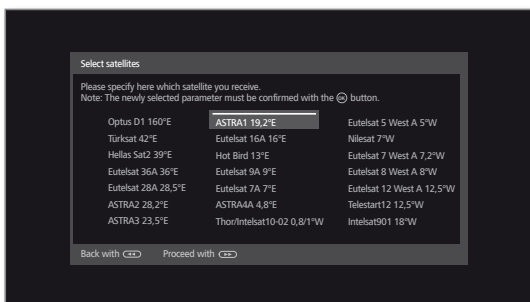

▲ ▼ ◀ ▶ Select satellite,
OK Confirm selection.



▶▶ Proceed to next step.

Dual/Single band

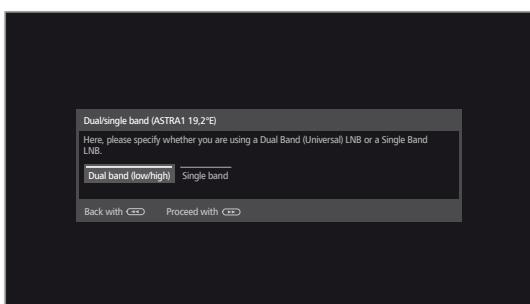

◀ ▶ Select **Dual band (low/high)** or **Single band**.
Here you specify if you use a Dual Band (Universal) LNB or a Single LNB.



▶▶ Proceed to next step.

LNC frequencies

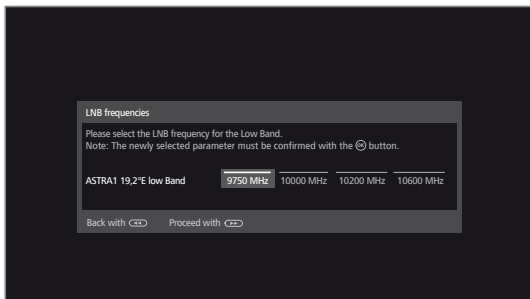

▲ ▼ ◀ ▶ Set LNB frequencies.
OK Adopt settings.

i The setting of the LNB frequency is only called when you have used the setting **Single band** in step **Dual / single band**.

Normally, you do not need to change the values for high and low band, unless the LNC (LNB) of your satellite system uses a different oscillator frequency (important for the frequency display).



▶▶ Proceed to next step.

Proceed to section **Setting options for DVB-S reception (continued)**.

Setting options for the satellite system (2 satellites on 22 kHz switchbox / 2 satellites on toneburst switch):

Satellite selection

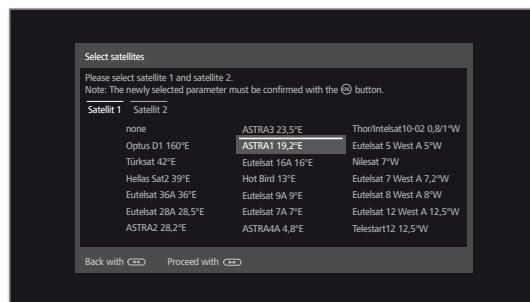

▲ ▼ ◀ ▶ Mark **Satellite 1 / Satellite 2**,
▶▶ select satellite.
OK Adopt settings.



▶▶ Proceed to next step.

LNC frequency (22 kHz Switch box)

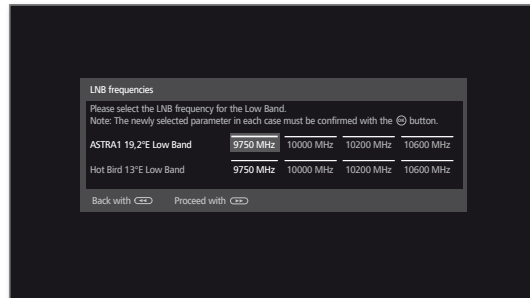

LNC frequencies (Toneburst switch)

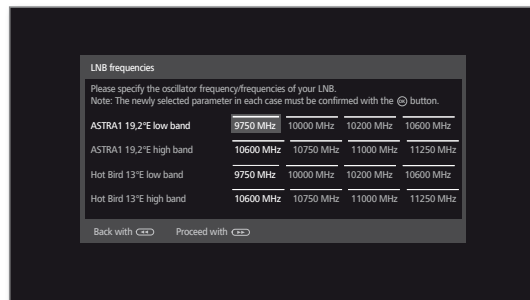

▲ ▼ ◀ ▶ Set LNB frequencies.
OK Adopt settings.

Normally, you do not need to change the values unless the LNC (LNB) of your satellite system uses a different oscillator frequency (important for the frequency display).



▶▶ Proceed to next step.

Proceed to section **Setting options for DVB-S reception (continued)**.

Setting options for the satellite system (max. 4 satellites on DiSEqC multiswitch):

DiSEqC
 multiple
 switch

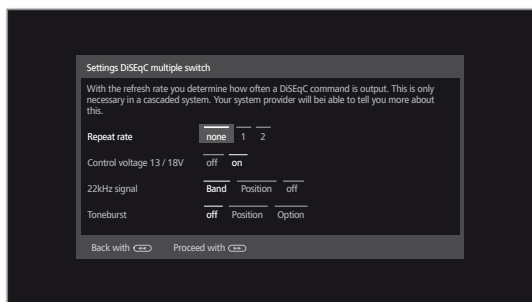

▲ ▼ ◀ ▶ Select and adapt settings for the DiSEqC multiswitch.
OK Adopt settings.

Repeat rate The refresh rate determines how often a DiSEqC command is output. A refresh is only necessary with cascaded systems.

Control voltage The control voltage controls the switching of the polarisation level (horizontal/vertical) in non-DiSEqC capable components (e.g., control of single LNBS via DiSEqC multiswitch).

22kHz signal The 22 kHz signal controls the switching between high and low band in the **Band** setting. The **Position** setting controls the selection of the satellites in non-DiSEqC capable components.

Toneburst The Toneburst controls the selection of the satellites in non-DiSEqC but Toneburst capable components with the **Position** and **Option** settings.



▶▶ Proceed to next step.

Satellite
 selection

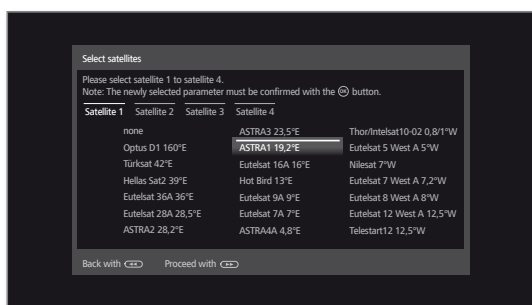

▲ ▼ ◀ ▶ Mark **Satellite 1 ... Satellite 4**,
 ▲ ▼ ◀ ▶ Select satellite.
OK Adopt settings.



▶▶ Proceed to next step.

LNC
 frequencies

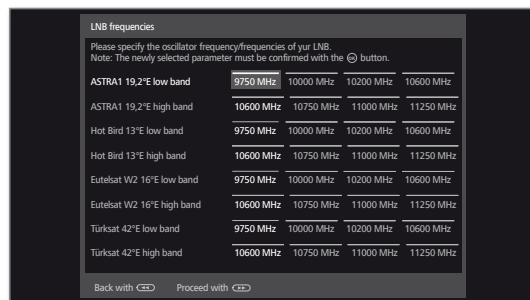

▲ ▼ ◀ ▶ Set LNB frequencies.
 Normally, you do not need to change the values.
OK Adopt settings.



▶▶ Proceed to next step.

Proceed to section **Setting options for DVB-S reception (continued)**.

Setting options for the satellite system (DiSEqC one cable communal system):

Number of system channel used

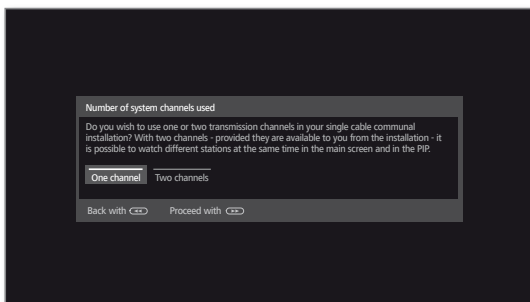

◀ ▶ Select **One channel** or **Two channels**.

i The number of system channels can be selected only when just one DVB-S antenna cable is used when selecting antennas.

Here you specify if you use one or two transmission channels in your one cable communal system. In case of two channels - as far as they are available in your system - different stations can be simultaneously viewed on the main picture and on PIP.

You get more information on your system from your dealer.



▶▶ Proceed to next step.

DiSEqC one cable communal installation

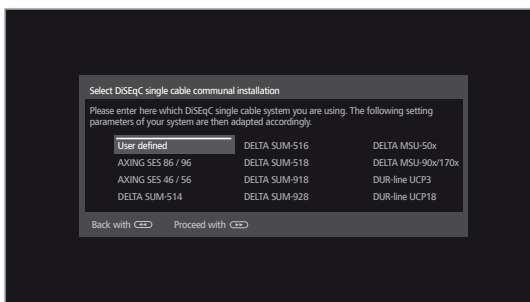

◀ ▶ ◀ ▶ Select DiSEqC single cable communal installation.



▶▶ Proceed to next step.

Satellite selection

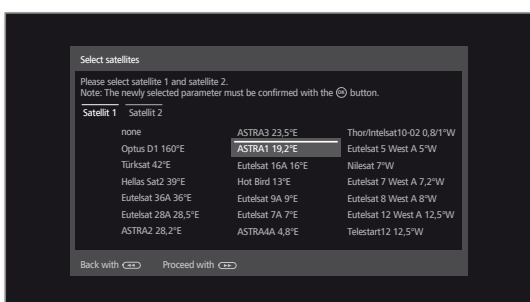

◀ ▶ ◀ ▶ Select satellites from list.
OK Confirm selection.



▶▶ Proceed to next step.

LNB frequencies

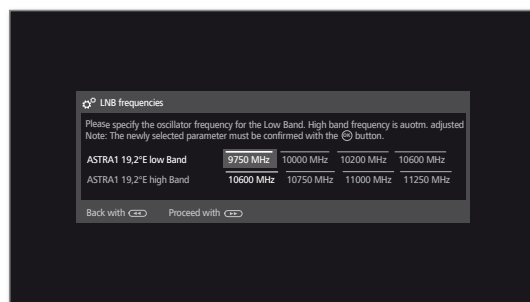

◀ ▶ ◀ ▶ Set LNB frequencies.
 Normally, you do not need to change the values unless the LNC (LNB) of your satellite system uses a different oscillator frequency (important for the frequency display).

OK Adopt settings.



▶▶ Proceed to next step.

Manual registration (for socket ANT SAT)

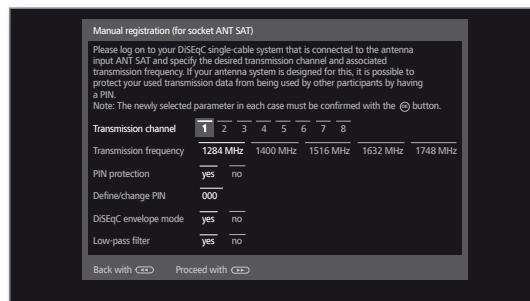

◀ ▶ ◀ ▶ Select and adjust settings for the DiSEqC single cable communal installation.

OK Adopt settings.

i The manual registration must be made for both ANT SAT jacks when either two DVB-S antenna cables or two system channels are used.

Transmission channel Select the desired transmission channel.

Transmission frequency Select the corresponding transmission frequency.

PIN protection If your system is designed for it, it is possible to protect your used transmission data from use by other subscribers with a PIN.

Define/change PIN Here you can determine and change the PIN for PIN protection. Only possible, when **yes** has been selected for PIN protection.



▶▶ Proceed to next step.

Proceed to section **Setting options for DVB-S reception (continued)**.

Setting options for the satellite system (other communal installation):

Select single satellite

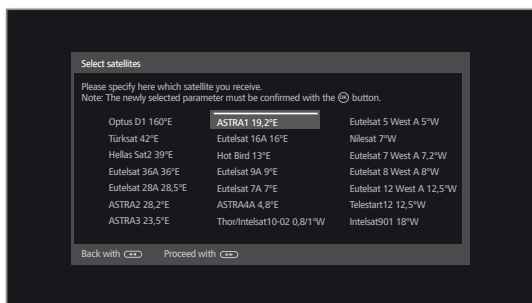

▲ ▼ ◀ ▶ Select satellite.
OK Confirm selection.



▶▶ Proceed to next step.

LNB frequencies, Supply voltage

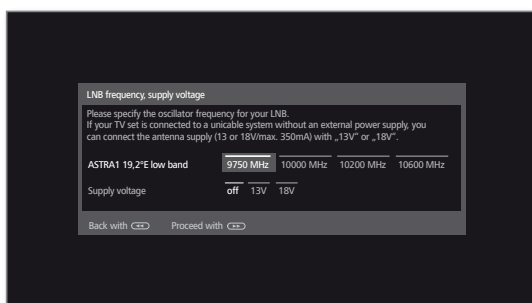

▲ ▼ ◀ ▶ Select and adapt settings.

LNC frequency Normally, you do not need to change the values for high and low band, unless the LNC (LNB) of your satellite system uses a different oscillator frequency (important for the frequency display).

Supply voltage If your set is connected to a single-cable system without external voltage supply, you can connect the antenna supply (13V or 18V / max. 500mA).



▶▶ Proceed to next step.

Proceed to section **Setting options for all types of reception.**

Setting options for DVB-S reception (continued):

Test reception

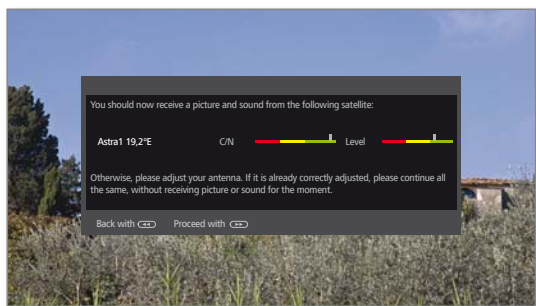

After you have made the previous settings, you should receive picture and sound of the selected satellites (only possible for Astra1 and HOTBIRD).



» Proceed to next step.

Settings

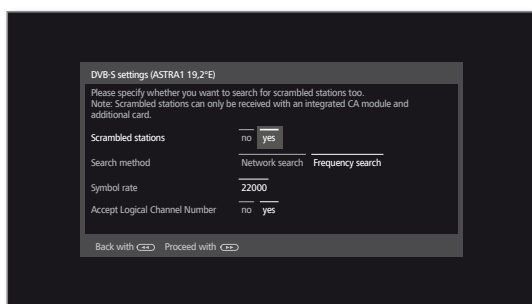

▲ ▼ ◀ ▶ Select and adapt settings.

If several satellites are received, the following settings must be made for every satellite. The type of settings available may differ depending on the selected satellite or network.

Scrambled stations You can state whether coded stations are to be searched for in the search/update.

Select **yes** to save all found scrambled stations. However, these stations can only be received in connection with a CA module and the appropriate Smart Card.

Handling of the CA module is described in chapter **System settings**, section **Extras – CA module**.

Search method If you select **Frequency search** here, a search is performed for all receivable stations. With **Network search**, from all receivable networks all the stations are searched which are supplied by these networks.

Depending on the selected network, this step might possibly be skipped.

Symbol rate The symbol rate is specified by the satellite provider and normally does not need to be changed.

Accept Logical Channel Number In various countries, digital stations (DVB-S) are transmitted with a preset channel number per station, known as Logical Channel Numbers (LCN).

If you select **yes** here, these default channel slots will be used and the channels of the preferred signal source will be sorted as per LCN. The stations in the station list can no longer be shifted.



» Proceed to next step.

Proceed to section **Setting options for all types of reception**.

Setting options for all types of reception:

Subtitle and audio languages (DVB only)

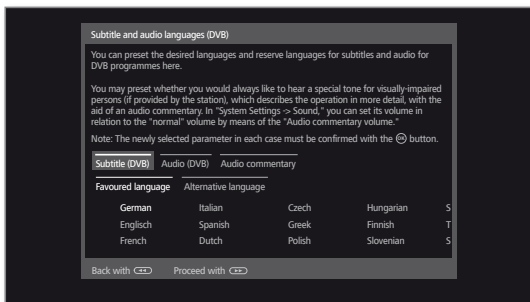

Select desired languages and alternative languages for subtitles and audio for DVB programmes.
 Set up audio commentary for the visually impaired.

OK Confirm selection.



Proceed to next step.

Check search settings

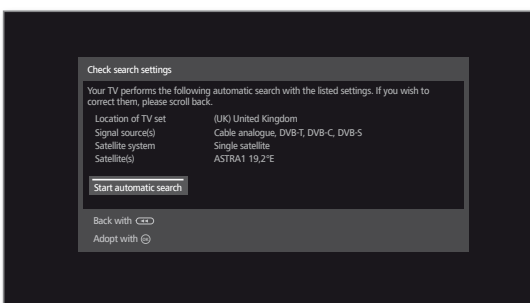

You will see a list of the selected settings. You can go back step by step with the key ◀ to make any changes to the settings.



OK Start automatic search.

Now, the TV set searches for TV and radio stations. It searches successively for stations from the selected signal sources. The progress of search is shown by a progress bar.

i In case of a repeated initial installation routine (via **Home** view under **System settings** → **Extras**) all stored stations will be first deleted here.

Info station search

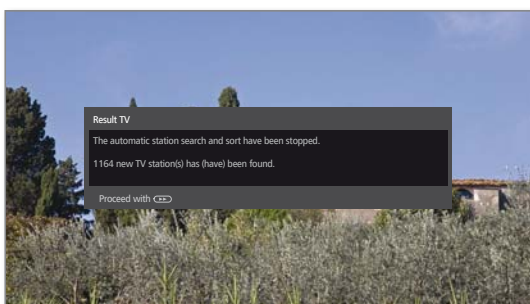

The number of found TV stations is displayed.

Proceed to next step.



The number of found radio stations is displayed.

Proceed to next step.

Age-related lock

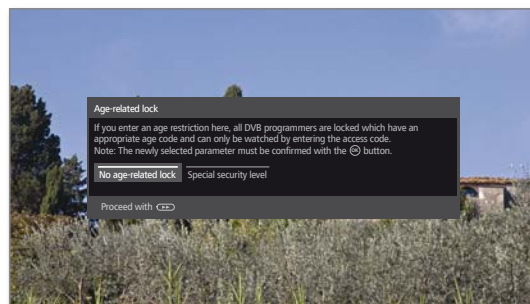

Select **Age-related lock**.
OK Confirm selection.

You can specify an age limit for your TV set here. DVB broadcasts which have an appropriate age identification are locked and can only be watched after entering the access code.

In some countries, the **yes/no** option does not exist for some channels, and a compulsory age check must be entered.



Proceed to next step.

Time and date

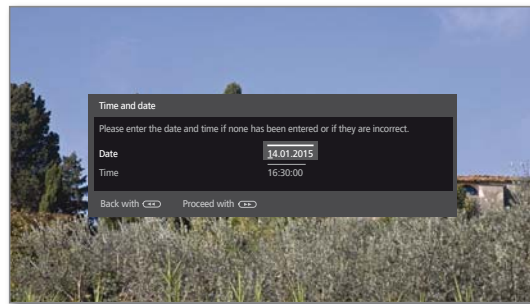

Proceed to next step.

The data capture for time and date is set to automatic ex factory.

If time and date are automatically obtained via the receive path, no entry is necessary.

For more information, see the chapter **System settings**, section **Control – Time and Date**.

Sound playback via ...

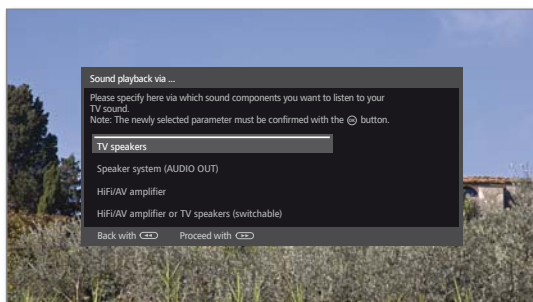

- ▲ ▼ Select sound components.
- OK** Confirm selection.

This selection indicates which sound components you want to use to hear your TV sound. Depending on the selection, the sound component wizard starts with which you can make further settings.

The sound component wizard is described in chapter **System settings**, section **Connections – Sound components** and can also be started at any time beyond the initial installation.



- ▶▶ Proceed to next step.

Network configuration

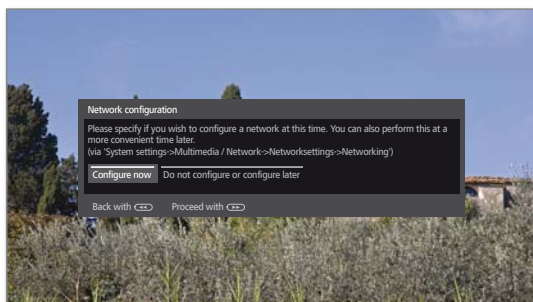

- ◀ ▶ Select option.

With the selection, specify whether you want to configure the available network adaptor now.

Configure now: Make settings for network adaptor and proxy server (see chapter **System settings**, section **Multimedia / Network – Network settings**).

Do not configure or configure later: Skip network adaptor configuration.



- ▶▶ Proceed to next step.

Inform about new software

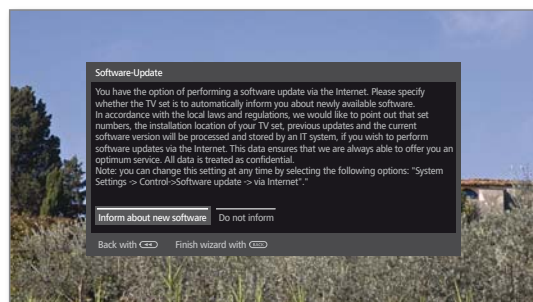

- ◀ ▶ Select option.

When selecting **Information on new software updates**, your TV set checks at definite intervals whether a newer software than the one installed in the TV set is available in the Internet. A screen message appears when a new software update is found.



Back: Exit wizard.

The initial installation wizard is complete.

TV set as a monitor

You can also use your TV set just as a monitor, i.e. if you only use it with a PC. The tuner in the TV set cannot be used in this mode.

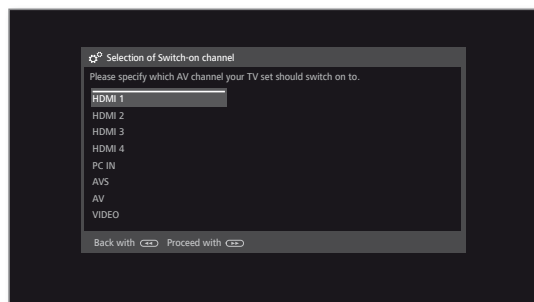

- ▲ ▼ Select AV connection.

The selected AV connection is shown when switching the TV on.



- ▶▶ Proceed to next step.

Initial setup continues with the **Time and date** setup.

Home view

The **Home** view is the central overview page for all of your TV set's operating modes.

The list of options on the left gives you access to the operating modes **TV, Video, Audio/Radio, Photo** and **Web**. By means of **System settings** you have access to more functions and you can configure your TV set.

The right part of the screen displays the favourites depending on the selected operating mode (see also right column) and the available sources.

i The number of selectable items varies depending on the TV equipment, network connection, available media/media servers and connected gadgets.

Call Home view



HOME: Calling the **Home** view.

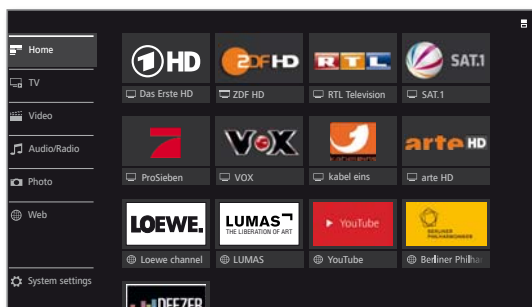

▼ ▲ ◀ ▶ Select menu item / Favourite / Source, **OK** call.

Description of the individual sections/functions:



Home: Under the item **Home** all favourites of the different sections are summarized.



TV: You can access the TV favourites and a variety of sources such as Station lists, EPG, Timer) via the item **TV**. See chapter **TV** for further information.



Video: The item **Video** gives you access to videos from local (USB, home network) and online sources. See chapter **Video** for further information.



Audio/Radio: With item **Audio/Radio** you find music files from your local server(s) and USB storage media as well as from DVB and Internet radio. See chapter **Audio/Radio** for further information.



Photo: Via menu item **Photo** you can view photos from your local media on your TV screen. See chapter **Photo** for further information.



Web: Here you have access to multimedia content in the Internet (MediaNet) as well as a high-quality web browser. See chapter **Web** for further information.



System settings: In menu item **System settings** you find the configuration menu of the TV set e.g., with settings for picture, sound, connections or sound components. See chapter **System settings** for further information.

Home view - Favourites

You will find your favourites on the right of the individual operating modes.

By selecting the operating mode, the favourites are filtered accordingly. When selecting **Home**, the favourites of all operating modes are displayed together.

i After an initial installation, some favourites will already be automatically created depending on the installation site of the TV set and of existing Internet links (e.g. TV stations, online links).

Creating favourites

In the operating modes of the TV set you can define the current object (e.g. station, music title, teletext page, website, photo, etc.) as favourite. In the selected operating mode, the active object will be added as favourite and placed at the end.



Create favourite.

If there are more favourites than can be shown on one page, this will be indicated by rectangular symbols in the upper line of **Home** view. Example:



Three pages with favourites exist. The first page of them is indicated. Equivalent is the display with the symbols for the source selection.



P+ / P- Scrolling through the individual pages.

Editing favourites

You can edit the existing favourites in **Home** view. Change the sequence of your favourites as you wish or delete favourites you do not need any more.



HOME: Calling the **Home** view.



◀ ▶ ▲ ▼ Select the favourite to be changed.



MENU: Change favourite. Move favourite or delete it (see below).

Moving favourites



◀ ▶ ▲ ▼ Move favourite to new position.



BACK: Finish procedure.

Deleting favourites



TEXT: Delete selected favourite.



BACK: Finish procedure.

Home view - Sources

To the right of your favourites, if any, you will find the selection of sources in the individual operating modes.

Depending on the operating mode, this can be, for example, different station lists (analogue, DVB-T, DVB-C, DVB-S, AV-list, extended station list), DVB radio, Internet radio, timer list, MediaNet, external USB storage devices, media servers on the network or the DR+ archive.

| |
|------------------|
| ■ One 55 |
| User manual |
| TV |
| Volume / Station |

TV

In TV mode that can be selected via the Home overview, you can use the basic TV functions of your TV set. In TV mode you will have numerous functionalities at your disposal as, for instance, PIP, EPG and, if offered by the station, HbbTV (hybrid broadcast broadband television). By means of the function list you may call additional options and settings all around TV operation.

Setting the volume

Switching sound off/on



Sound off.
Sound on: Press key again or increase the volume using **V+**.

Setting the volume

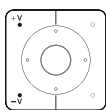

V+ / V- Volume up/down.
The volume control bar will be displayed in the upper right corner.

i The volume control bar can be deactivated in the menu **System settings** → **Control** → **more ...** → **On-screen displays**.

Select station

Select station with P+ / P-

When using Instant Channel Zapping, you can very quickly switch to other stations. The instant channel zapping technology uses the second tuner in the background in order to pre-select the next stations. Due to this pre-selection, you can now switch to this channel within a very short time.

i While using the digital recorder DR+ with externally attached USB hard drives (time-shift operation, archive recording) or in the PIP mode, Instant Channel Zapping is not available. Switching takes place at „normal“ speed.

i For encrypted stations Instant Channel Zapping is only possible to a limited extent.

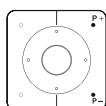

P+ / P- Station up/down.
The number and the name of the station along with the title of the programme and that of the next programme will be briefly shown. Also, the status display with time/date and programme-dependent symbols appears.

i The symbols of the status display are described in chapter **TV**, section **Status display**.

Select station using the numerical keys

i If you select an unoccupied station position, the next available station is selected.



1-digit stations
Press the **numerical key** a little bit longer: The channel will change immediately or press the **numerical key** briefly, the station changes after 2 seconds (changes immediately if up to 9 stations are stored).

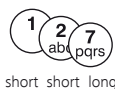

2-digit and 3-digit stations
Press first (and second) **numerical key** briefly. Keep the last **numerical key** depressed a little bit longer: The channel will change immediately or: press all the **numerical keys** briefly, the channel changes two seconds after the last number has been entered (with up to 99 or 999 saved channels it will change immediately).



4-digit stations
Press all four **numerical keys** briefly, the station changes immediately.

Selecting a station out of the station list



i In normal TV mode, without other displays:
OK Call station list.

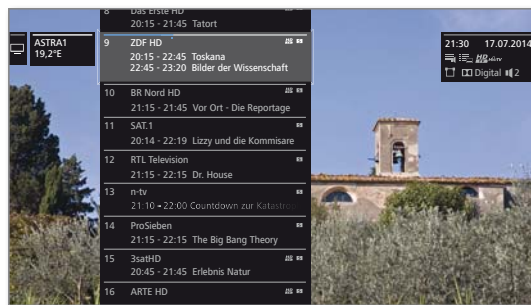

▲ ▼ Mark stations,
OK the marked station will be called.

Changing the station list



i In normal TV mode, without other displays:
OK Call station list,
◀ call overview of station lists.

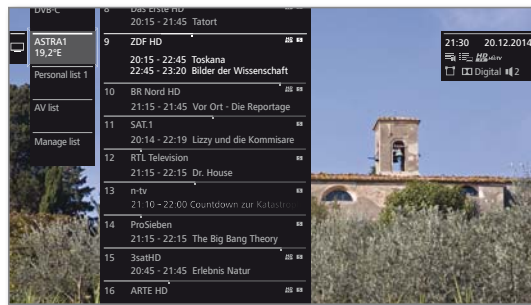

▲ ▼ Mark the desired list.
The station list will be changed according to the selection. The list will be adopted automatically.
▶ Move to the newly selected list.

Explanations of the station lists:

i The number and the names of the possible station lists depend on the available signal sources (antennas, TV reception networks, etc.).

- ASTRA LCN Analogue DVB-C DVB-T Only stations from the selected source / reception network are indicated in the station list.
- Personal list Only stations of the selected personal list are indicated in the station list. The name of the list may be changed.
- AV list Exclusively AV inputs are shown in the station list.
- Manage list Call up the station list editing menu (**System settings** → **Stations** → **Station lists TV**).

continued on the next page →

Selecting stations by means of the expanded station list

i In normal TV mode, without other displays:



OK Call station list,
▶ call function list.

▲ ▼ Mark **expanded station list**,
▶ call expanded station list.

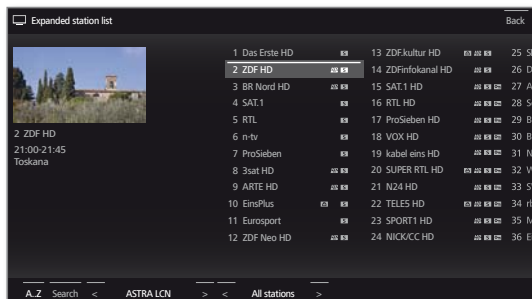

P+/P- Scrolling in the station list page by page.



▲ ▼ ◀ ▶ Mark stations.
OK The marked station will be called.

Or:



For numerical sorting: Enter the channel number. The marker will jump to the selected station.



OK The marked station will be called.



For alphabetical sorting: Enter the first letter. The first station for the specified letters is marked.



▲ ▼ ◀ ▶ Mark the station.
OK The marked station will be called.

Filter and sort options of the expanded station list

Using the on-screen buttons on the bottom line of the expanded station list you can filter and sort the station list by various options.



MENU: Switching between list and bottom line.

0..9 Numerical sorting of the station list.

A..Z Alphabetical sorting of the station list.

Searching This allows you to do targeted searches for stations. The station name is to be entered via the on-screen keyboard. The entry is described in chapter **General information on the operation**.

Signal source Select the signal source, the stations of which are to be displayed in the extended station list (e.g., Analogue, DVB-C, DVB-T, ASTRA LCN, Personal station list, AV list).

All stations Here you can filter the content of the station list according to various criteria. Shall **All Stations**, only **HD** stations, stations that are **Locked** or **Scrambled** or **Unscrambled**, **CI+ Protected** stations be indicated.

Selecting stations by personal lists

You can save your preferred stations in personal lists (e.g., for several users). Each personal list can contain up to 99 stations.

i Personal list available (creating a new personal list via **Manage list** → **New personal list**).

i In normal TV mode, without other displays:



OK Call station list.
◀ Open overview of station lists.

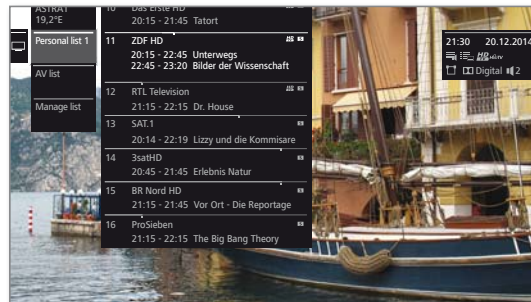

▼ ▲ Mark the desired personal list.
The station list will be changed according to the selection. The list will be adopted automatically.
▶ Move to the newly selected list.

▲ ▼ Mark the station.
OK The marked station will be called. Or:



Select station directly with **numerical keys**.

Explanation of the icons following the station names:



Locked station.



HDTV station.



DVB-T station (digital terrestrial via antenna).



DVB-C station (digital via cable).



DVB-S station (digital via satellite).



Scrambled station.

History

Recently selected stations are saved in History.

i In normal TV mode, without other displays:



Yellow button: call History.



▲ ▼ Select entry.
OK call.

The last station can also be selected directly:



Yellow button pressing longer: last station¹⁾.

¹⁾ Software version 2.1.x and higher.

Status display

i In normal TV mode, without other displays.



INFO: Show status display.

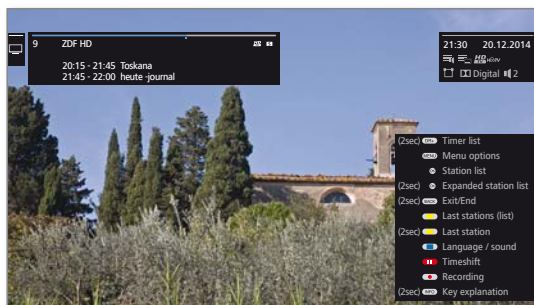

In the left upper corner you will see in the marked field the number and name of the station, the transmission time and (if available) the title of the current programme. The bar (if available) indicates the progress of the current programme. If information about the current programme is available, this can be called by pressing the **INFO key** again.

In another adjacent field to the right, the programme info of the following programme is displayed additionally for DVB stations.

The field in the upper right corner contains the time, the date and, depending on the DVB station and according to availability, various additional information, which is represented by symbols (see column on the right).

A window with button descriptions is displayed in the bottom right corner. The automatic display of the Explanation of keys with status display can be switched off via **System settings** → **Control** → **more ...** → **On-screen displays** → **Key explanation**.

By pressing the **INFO key** longer the Explanation of keys can be displayed regardless of the status display (see also chapter **On-screen displays**, section **Explanation of keys**).

The status display is shown automatically every time you change channels.

The status display is hidden automatically at the end of the display time.

If you want to hide the status display manually before the display time ends, you can do this with the **BACK key**.

Explanations of the symbols in the status display:

General symbols:



Language/sound selection available.



Subtitles available.



Channel selection for multi-channel providers.



HDTV programme.



HbbTV mode available from this station.

Transmitted audio signal:

Mono

Mono audio transmission analogue.

Dual channel

Dual channel sound transmission (Sound1/Sound2) analogue.

1+1

Dual channel sound transmission (Sound1/Sound2) digital.

Stereo

Stereo sound transmission analogue.

Stereo (AAC+)

Stereo sound transmission (HEAAC).



Stereo sound transmission digital (PCM).

DD Digital

Dolby digital sound transmission (DD).

DD Digital+

Dolby digital sound transmission (DD+).

DD Digital (AAC+)

Dolby digital AAC+ sound transmission (HEAAC).

MPEG

MPEG sound transmission.

Transmitted audio channels:



DD 1.0 / Mono



DD 2.0 / MPEG 2.0



DD 3.0



DD 4.0



DD 5.0



DD 2.1



DD 3.1



DD 4.1



DD 5.1

Function list (TV mode)

The function list contains settings and additional options. The individual List items will be briefly explained as follows:

i The function list can be opened for the current station or the selected station list. Depending on this, some list items may possibly not be available.



Function list for the current station:

MENU: Call function list.



Function list for the selected station list:

OK Call station list,
 ▶ call function list.

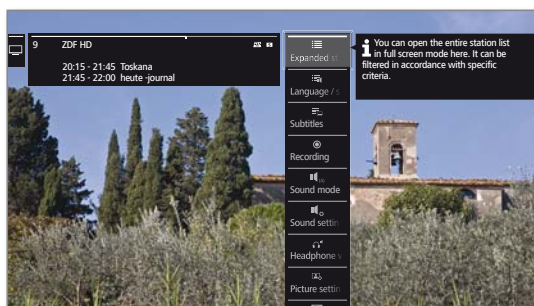

▲ ▼ Select function,
OK call.

Explanations of the symbols in the function list:

- Open **Expanded station list**.
- Call up **Language / sound**. The available sound formats and their designations depend on the programme being broadcast.
i Menu item will only be indicated when several languages/ sound tracks are available.
- Call up **Subtitles** selection.
i Menu item will only be indicated when subtitles are available.
- Open recording dialogue to programme a **Recording**.
- Set **Sound mode** (number of speakers).
- Call up **Sound settings**.
- Call up and adjust **Headphone volume**.
- Call up **Picture settings**.
- Activate **PIP**.
- Move picture vertically up/down.
- Switch screen off.
 Switching the screen ON again: **OK**, **BACK** or **green coloured key**.
i The menu item is only shown when DVB radio, Internet-radio or an AV source is active.
- Add current station as **Favourite** to **Home** view.
- A-Z** Changes the **Sorting** between numerically and alphabetically.
i Menu item is displayed only when the function list for the station list is opened (see above).

Explanations of the symbols in the function list (continued):

- Call **Edit station list**.
 Delete stations, shift stations, restore deleted stations.
i Menu item is displayed only when the function list for the station list is opened (see left column).
- Call **Rename**.
 The name of analogue stations and the designations of the connections in the AV list can be changed.
- Call **Store stations**.
 Add current station to a favourites list.
i The menu item is only shown, when at least one favourites list is available.

AV list (AV Source)

Selecting the AV source via the AV list

i In normal TV mode, without other displays.



Open station list **AV list**.

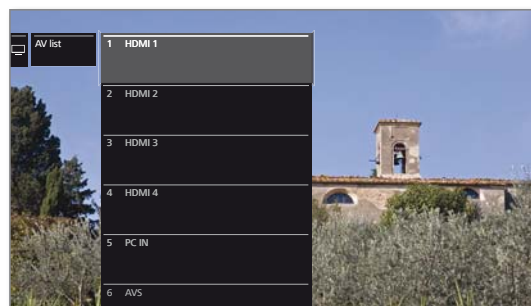

▼ ▲ Select desired connection,
OK switch over.

If the selected AV source provides a signal (picture), it should be visible now.

When selecting **VIDEO**, you switch to the signal source **Cable analogue**, channel **E36**. The TV set can display the signal from an external source via the antenna input **TV ANT**.

Only playback of the audio signal from the AV source (screen is off)

To play only the sound of a connected media player (e.g. MP3 player), the AV sources can be selected so that the screen goes blank.

i Switching off the screen reduces the power consumption of the TV set.



Open station list **AV list**.



▼ ▲ Select desired connection,
OK press at least for two seconds.

Selecting the AV source via the station list

i In normal TV mode, without other displays.



OK Call station list.
 ◀ Call overview of station lists.

▼ ▲ Select **AV list**.
 The AV list will be displayed.

▶ Move to the AV list.

▼ ▲ Select desired AV source,
OK switch to AV source.



Electronic Programme Guide – EPG

EPG stands for Electronic Programme Guide and provides you with on-screen broadcast details. With the system, as with a printed programme guide, you can learn about the current broadcast. In addition broadcasts can be sorted according to certain topics, memorised, and also recordings can be programmed.

Starting and ending EPG

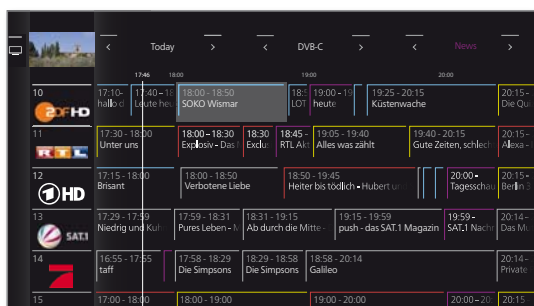
 **EPG:** Switch EPG on / off.



-  EPG is only available for DVB stations.
-  The first time you start EPG, a wizard will start that guides you through the necessary presettings.
-  Depending on the number of stations selected for EPG, it may take some time until the broadcast information is displayed.

EPG wizard

In this dialogue you decide, for which station EPG data should be collected and displayed. With the number of stations the time for nocturnal data acquisition will increase. We recommend, also for reasons of distinctness to select only those stations, which you receive regularly.

When the EPG is started for the first time:

 **▶▶** Continue in the wizard and call up the EPG Station selection.

 **MENU:** Switch between the station list and the on-screen buttons in the bottom line.

Changing the station list:

 **◀ ▶ ▲ ▼** Mark station list in the bottom line, **OK** select desired station list.

Select station for EPG:

 **◀ ▶ ▲ ▼** Mark the the single station, **OK** Select / deselect station for EPG.

For display in the EPG, the selected stations are marked with a check mark .

Or:











 **◀ ▶ ▲ ▼** Select **Mark all**. **OK** All stations of the station list will be activated for EPG.

Or:

 **◀ ▶ ▲ ▼** Select **Unmark all**. **OK** No station is activated for EPG.

Meaning of the colours in the EPG

The coloured labels indicate the genre of the respective broadcast. When filtering with genre selection in the header, the broadcasts of the selected genre will be highlighted.

-  Movies
-  News
-  Show
-  Sports
-  Child
-  Music
-  Arts
-  Social
-  Education
-  Hobby

EPG Operation

In the left column there is a list of stations of the selected source/station list (e.g. DVB-C, personal list). With the on-screen buttons in the header of the EPG you can select the day of the broadcast preview, change the source and filter the broadcasts as to their genre.



P+ / P- Scrolling in the station list page by page.



- ◀ ▶** Scrolling in the station list.
- ◀ ▶** Scrolling through the broadcasts.

OK short: (highlighted TV broadcast is running): EPG will be closed and the broadcast is selected.

short: (highlighted broadcast not yet started): Detailed information on the selected broadcast will be called.

long: Change preview image to the station of the highlighted broadcast.



INFO: short: Call detailed information on the selected broadcast (see next page).
 long: show Explanation of keys.



REC: Schedule the recording of the highlighted broadcast.

Control in header:



MENU: Go to header.



- ◀ ▶** Mark selection of date, source, genre.
- OK** Accept changes.



MENU: Move from date to genre or from genre to station list.

Switching to the current broadcast



- ▲ ▼ Mark current broadcast.
 - OK** press briefly: switch to current broadcast.
- The electronic programme guide will be closed.

Broadcast preview



- ▲ ▼ Mark desired station in the station list.
 - OK** press long: show preview.
- In the top left window, the current broadcast of the selected station is displayed now.

Jumping to time or station

i The marking must be in the station list.



Press the **numerical key** (0 through 9). The window **Select Time/Station** is shown.

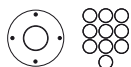
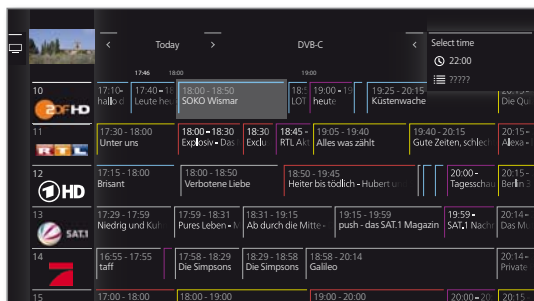

- ▲ ▼ Select time or station, Enter numbers.
- i** When entering a time, you always jump to the next occurrence of the entered time (24-hour window). If the time is already passed today, the time entered will appear on the following day.
- i** Always enter five digits for station presets, e.g. **00001** for preset 1 or **00134** for preset 134.



OK Activate jump.

Calling additional information about the broadcasts



INFO: Call up detailed information.

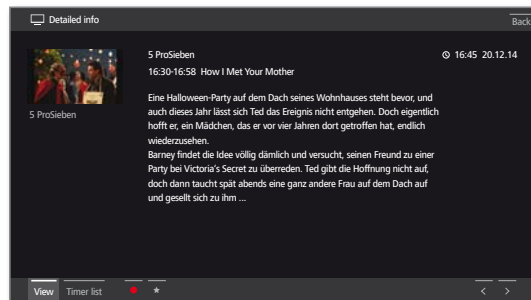

If there is more information on the selected broadcast, it will be indicated here. You find further information on the indicated broadcast in the bottom line:

- View** Watch selected TV broadcast.
 - i** The menu item is only available when the selected broadcast is on the air.
- Memorise** Memorise the broadcast for later watching / listening. For further information see next page.
 - i** This menu item is only available when the selected broadcast has not started yet.
 - i** Depending on the presetting the TV set will switch on by itself when it is in standby.
- Delete memo** For broadcasts being memorised you can also delete the memo.
- Timer list** Call up timer list.
 - Schedule the recording of the selected broadcast for a time.
 - ★** Schedule the recording of the selected broadcast for a time. Additionally, an entry to the **Home** favourites will be added as soon as the recording starts.

Recording a broadcast via EPG

You can programme timer recordings of TV broadcasts conveniently using the EPG.



▲ ▼ ◀ ▶ Select the desired broadcast.

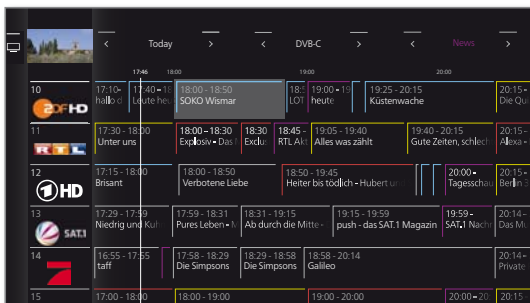

RECORD key: Programme timer recording for the TV broadcast.

Timer data dialogue is opened.

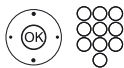
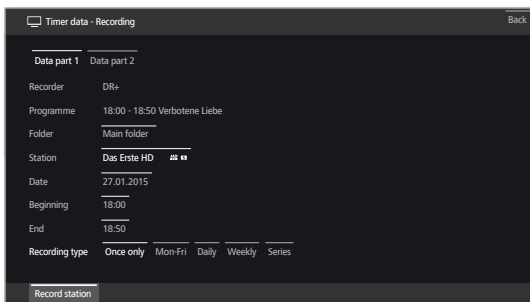

Check the timer data and update it if necessary (e.g. directory, start, end, recording type).

See chapter **TV**, section **Timer** for explanations of the setting options in the **Timer data** menu.



◀ ▶ ▲ ▼ Select **Record station**.
OK adopt.

In the EPG a recording symbol ● is placed behind the title of the broadcast.

Memorising a broadcast via the EPG

A broadcast that has not started yet can be memorised. For memorised broadcasts, the TV set will ask at the beginning of a programme if it should change the channel accordingly or switch on from the stand-by mode if this is activated in the menu **System settings** → **Control** → **EPG** → **TV on when memorised**.



◀ ▶ ▲ ▼ Mark the desired broadcast.
OK Call up detailed information.

◀ ▶ ▲ ▼ Mark **Memorise**.
OK Memorise broadcast.

In the EPG, a memorise symbol is placed behind the title of the broadcast.

After a software update, it is likely that Memos of broadcasts are deleted. After a software update, please check your timer list (see chapter **TV**, section **Timer**).

Adapting the EPG Overview

The options to be selected are in the header, if not, press **MENU key**.



◀ ▶ Select day or genre.
OK Confirm selection.

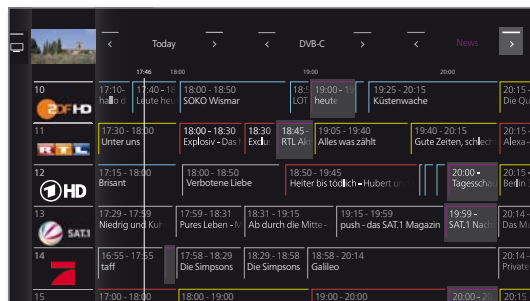

Example If you look for the next newscast select and **news** under genre. Newscasts will be highlighted.

Adapting the EPG view



PIP: Switch in EPG view between standard and compact view.

Standard view:

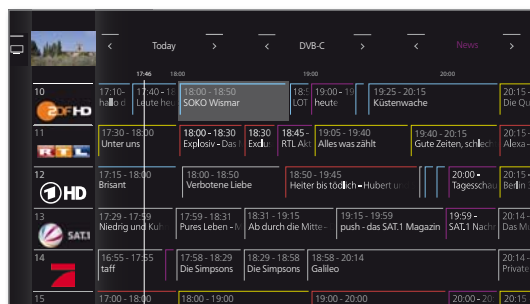

Compact view:

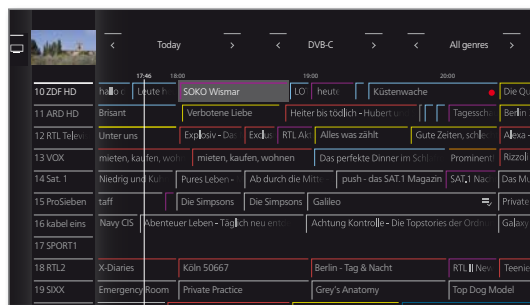

Configuring EPG

You can find the EPG settings in the chapter **System settings**, section **Control – EPG**.

| |
|-------------|
| One 55 |
| User manual |
| TV |
| Teletext |

Teletext

Your TV set supports the two operating systems TOP text and FLOF. Up to 2000 pages are stored in order to get quick access.

Starting and ending Teletext



TEXT: Call teletext.

The function of the **TEXT** key can be set under **System settings** → **Control** → **more ...** → **HbbTV** → **Function of the TEXT key**.

The factory default is **Standard teletext first** (see also chapter **System settings**, section **Control** – **HbbTV**).

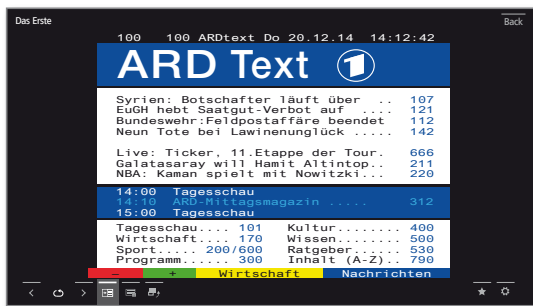

TEXT: Switching between Standard Teletext and MediaText.



Pressing the **BACK** key ends Teletext.

Key functions for Standard Teletext operation



INFO press longer: Show Explanation of keys.



IINFO or **BACK:** Hide Explanation of keys.



0-9: Directly enter the page number.



0 AV: Stop self changing pages.



9: Zoom in the page (press several times).

Page selection with the coloured keys



Red key: One page back or back to previous page (depending on Teletext provider).

Green key: Advance one page.

Yellow key: To next topic.

Blue key: To next range of topics.

The coloured bars (with TOP text) or the coloured writing (with FLOF text) in the last to bottom line show you which colour button you need to use to select which topic areas and topics.

Page selection with P+ / P-



P+ call next Teletext page.

P- call previous Teletext page.

Additional page selection possibilities



First possibility:

INFO: Call **overview page 100**.



Second possibility:

Directly enter the page number.

Third possibility:

I The page includes 3-digit page numbers.

▼ ▲ Mark desired page number.



OK Call page.

Fourth possibility:

I The page consists of several sub-pages, indicated by the symbol and the arrows in the bottom line.

▼ ▲ Go to bottom line.

◀ ▶ Mark < or >.

OK select previous / next sub-page.

I The number of the current sub-page is shown between the arrows.



Explanation of the symbols in the Teletext bottom line

| Symbol (icon) | Remote control key | Description |
|---------------|--------------------|--|
| < | - | For Teletext pages with sub-pages: Show previous sub-page. |
| > | - | For Teletext pages with sub-pages: Show next sub-page. |
| | PIP | Hide TV picture (Teletext as full screen). |
| | PIP | Insert TV picture (Split screen Teletext/ TV Picture). |
| | - | Activate Newsflash mode. |
| | - | Show hidden information on the Teletext page. |
| | - | Hide information on the Teletext page again. |
| ★ | | Add current Teletext page to the favourites in Home view. |
| ⚙ | MENU | Call function list with Teletext settings. |

Newsflash

Some text pages, e.g., live tickers, will be permanently updated. In order to keep track of changes and also to be able to watch the TV programme at the same time you may hide the Teletext temporarily and can still remain informed on updates of the page.



◀ ▶ ▲ ▼ Mark  **Newsflash**,
OK confirm.

The future behaviour of the News function depends on the type of the Teletext page:

In case of Full screen Teletext pages the Teletext will be hidden. In the bottom right corner, there will be a symbol for the activated news function.



A screen message appears when the contents of the page has changed.



Show updated page.



◀ ▶ Select **yes** or **no**.
OK Confirm selection.

In case of Teletext pages which cover only a part of the Teletext page, e.g., News tickers, the respective part will be faded in and permanently updated.

End News function



OK show Teletext again.

Or:



BACK: exit Teletext.

HbbTV / MediaText

HbbTV¹ (Hybrid broadcast broadband television) offers the user comprehensive multimedia contents, e.g., media centres or additional information on the current programme as far as they are provided by the station (Value-added service).

MediaText helps you to use the next generation of teletext/videotext for HbbTV.

MediaText/HbbTV text can either be started directly or through an HbbTV application.

i The TV must be connected to the Internet to use HbbTV/MediaText. A connection speed of at least 6,000 kbit/s (DSL 6000 or equivalent) is recommended for smooth playback of videos.

Opening an HbbTV application

If an HbbTV application is available for the chosen channel after changing channels, this will be loaded during the automatic start process and a red key symbol will appear. When starting manually, the application will be loaded not until you press the red key.

The start behaviour can be set under **System settings** → **Control** → **more ...** → **HbbTV** → **Function of the TEXT key** (see also chapter **System settings**, section **Control – HbbTV**).

- i** HbbTV is offered by the selected channel.
- i** Connection to the Internet established.
- i** HbbTV mode is set to **on**.

    **Red key:** Load / display HbbTV application.



The appearance, key assignment and available functions of the HbbTV applications are dependent on the provider.

Under certain circumstances, the recording and bookmarking functions of the applications may not be supported.

Loewe do not guarantee the accessibility, functionality or content of HbbTV applications.

Hide / Close HbbTV application

 **BACK:** Hide / Close HbbTV application.

Depending on the set start behaviour, the HbbTV application will be hidden (automatically) or closed (manually). In the start behaviour **Automatic**, you need to press the **BACK key** a second time for closure. You will see a screen message after closing.

Opening HbbTV text directly

i Depending on the programme provider, the direct Call of MediaText may not be possible. MediaText must then be opened by means of the HbbTV application.

i MediaText/HbbTV text is offered by the selected channel.

i Connection to the Internet established.



TEXT: Call up "standard" Teletext (see chapter **TV**, section **Teletext**).

By pressing the **TEXT key** a second time the MediaText/HbbTV Text will be called up.

i The function of the **TEXT key** can be set.



Navigation within the HbbTV Text and how the coloured keys are assigned can vary depending on the provider.

Terminating the HbbTV Text



Pressing the **BACK key** ends HbbTV text.

HbbTV services for DVB radio

Various DVB radio stations also offer HbbTV text/media text. The functionality is the same as in TV mode.

¹ Depending on the settings selected.

Picture in Picture (PIP)

The concurrent display of two different images is referred to as Picture in Picture.

Starting and ending PIP mode



PIP: Show/hide PIP display.

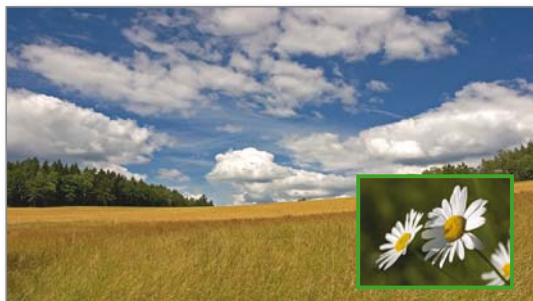

Selecting the station of the PIP picture

If the frame colour of the PIP picture is not green, press the **green key**.

Select the station as usual. (see also chapter **TV**, section **Select station** or section **AV list**).



Select the station for the main picture

If the frame colour of the PIP picture is not white, press the **green key**.

Select the station as usual. (see also chapter **TV**, section **Select station** or section **AV list**).

| Simultaneous display of... | ● (yes) / – (no) |
|---|------------------|
| a digitally broadcast channel (DVB-T/C/S) and picture from a digital AV source (e.g. HDMI1) | ● |
| a channel via digital satellite (DVB-S) and a channel via analogue cable television | – |
| a digitally broadcast channel DVB-T/C and a channel over analogue cable television | – |
| a digitally broadcast channel over DVB-T/C and a satellite broadcaster (DVB-S) | ● |
| two channels over analogue cable television | – |
| two digitally broadcast channels (DVB-T/C/S) | ● |
| a free-to-air and an encrypted digitally broadcast channel (DVB-T/C/S) | ● |
| two encrypted channels | ● |
| an SDTV channel and an HDTV channel (DVB-C/S) | ● |
| two HDTV channels (DVB-C/S) | ● |

Coloured key functions

If the frame colour of the PIP picture is not green, press the **green key**.

Yellow key: Swaps contents of TV picture and PIP picture.

Blue key: Start/stop PIP scan in the PIP picture.

Change PIP position



In normal TV mode, without other displays.

◀ ▶ ▲ ▼ Move PIP to one of the screen corners.

PIP Settings

The size of the PIP display can be set in the **System settings** under **Control → more ... → PIP** (see also chapter **System settings**, section **Control – PIP**).

The functions and settings can be executed and done via the PIP menu as well.

If the frame colour of the PIP picture is not green, press the **green key**.



MENU: Call menu.



▲ ▼ Select function, **OK** call.

If Picture change and station selection are restricted during recording.

In PIP mode, it is generally not possible to use analogue stations and analogue sources (AV, PC IN etc.) for main/PIP picture.

TV viewing with time shift

You can use the Digital Recorder of your Loewe TV set to record programmes on an externally connected USB hard disk.

After you have started the timeshift television, the programme will be recorded in the background. You can stop the TV programme at any time and continue watching it later with a time shift. The maximum time shift is three hours.

During timeshift operation, the programme is **not** stored permanently. If you would like to save programmes for a longer time, use the archive recording (see next page).

- i** Recording of analogue stations is not possible.
- i** Time-shifted operation is perhaps not possible or only to a limited extent for programmes of stations working with CI Plus encryption.

Interrupt watching (start timeshift television)

 Press **PAUSE key**.

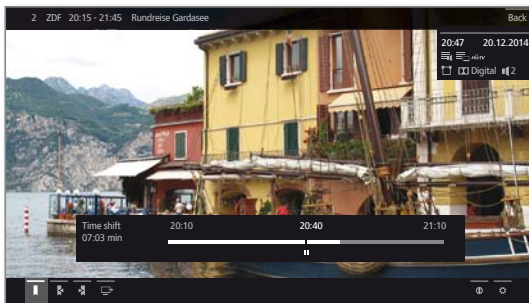

The TV image becomes a freeze frame and the DR+ status display appears.

At the top you will see the number and name of the station, start, end and the title of the current programme.

In the lower part of the screen at the beginning of the time bar you find the starting time of the background recording. On the right hand side of the bar you can see the time at which the time shift recorder will be full (automatically extends by 30 minutes, up to a max. 3 hours).



The time above the bar at the PAUSE key shows the current time.

Continue (time shift viewing)

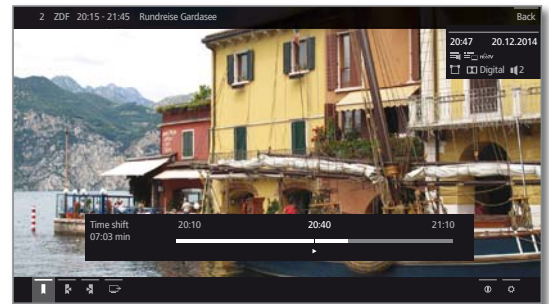
 Press **PLAY key**.



You can now continue watching the TV programme at the time when you had pressed the **PAUSE key**.

The Playback symbol  appears instead of the Pause symbol .

For further options of time-shift watching see chapter **Video**, section **Video playback**.

Returning to live picture (end timeshift television)

 Press **STOP key**.
You see the station's live picture again.

Switch to a different station

If you switch the channel, the time-delayed recording (time shift) is restarted. The current time-delayed recording is discarded (time shift buffer is emptied).

When switching between encrypted and unencrypted contents of the same station the timeshift buffer is also cleared.

When doing this, the timeshift television is interrupted and you see the live picture of the broadcast.

As a precaution, start archive recording of interesting broadcasts when watching stations with changing coding.

Setting bookmarks

You can manually set bookmarks during time-shift TV watching. For this, the time shift recording is converted into an archive recording.

Archive recording

Programmes that you wish to watch at a later date can be recorded in the Digital Recorder Archive (DR+ archive) of an externally connected USB hard disk.

A recording can be made manually (instant recording / direct recording) or as timer recording. The timer data can again be entered manually or more comfortably, for example, via EPG.

If EPG or teletext data is available, the Digital Recorder stores the title and additional information on each programme in the archive.

If additional languages are being transmitted for a DVB broadcast, these will also be recorded. DVB subtitles can also be recorded.

You can watch another programme or playback a recorded TV programme from the archive while recording a TV programme into the archive. But you can also play back the programme that you are just recording with time-shift.

With multi recording two programmes can be recorded simultaneously (see chapter **TV**, section **Digital Recorder – Multi recording**).

During the archive recording, the bar showing the recording progress is red.

- i** Recording of analogue stations is not possible.
- i** Recordings of CI Plus encrypted programmes (e.g. RTL HD, Sat 1 HD, Pro 7 HD, etc.) are perhaps not possible or only to a limited extent.

Instant recording (One touch recording) / Direct recording

With One Touch Recording, the recording starts immediately at the press of a button. For direct recording, the recording will start only after entering the recording duration.

- i** The programme will be recorded starting from the point at which recording was started. If the programme (or a part of it) is in the timeshift buffer (see left column, timeshift television), this part is also saved.

 One Touch Recording
 Press **REC key** longer: The current programme is recorded immediately.

 Direct recording:
 Press **REC key** briefly.

 ◀ ▶ Select recording duration,
OK confirm.
 If desired, adjust timer data (e.g. directory, start, end, recording type).

 ◀ ▶ ◂ ▸ Select **Record station**,
OK adopt.

Watching other stations during archive recording

After you have started the recording, you can switch to another station.

- i** The second channel can be watched in time-shift TV whilst a recording is taking place (Time shift during archive recording).

Viewing another programme from the archive during archive recording

After you have started the recording, you can also watch a programme you have already recorded.

 Open the **DR+ archive**.

 ▼ ▲ Mark the recorded programme,
OK view programme.

The recording process is continued in the background.

Time shift viewing during archive recording

Whilst an archive recording is taking place you can play back the programme that is being recorded or watch a programme on another channel using time delay.

 **PAUSE key:** Switch to freeze picture.
 The recording is continued in the background.

Display during time-shift viewing and archive recording:

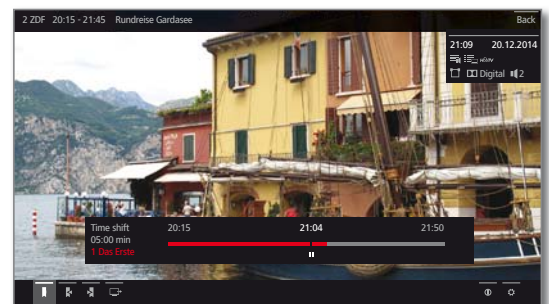

 **PLAY key:** Continue playback.
 You will now see the time-shift archive recording.

For further options of time-shift watching see chapter **Video**, section **Video playback**.

 **STOP key:** End time shift and return to the live picture of the current archive recording.

Subsequent archive recording

You can also save an already viewed and finished broadcast in the archive provided there has been no change of station in between.

Skip or wind back to the desired broadcast and start the recording.

Setting bookmarks during archive recording

During a running archive recording you can create bookmarks (by pressing the **PLAY key** a little longer). You will see a message on the screen.

Bookmarks also serve as starting and end points of intervals.



Subtitles

Subtitles of a broadcast can also be stored during recording.

i The recording of subtitles in DR+ continuous mode must be activated in the settings.

Calling up the subtitles during a later playback is similar to calling subtitles in TV mode.

Timer-controlled recording

Comfortably select your favourite programme for recording from the EPG. The timer overview has room for 50 entries.

You will find further information on timer-recording in chapter **Extras**, section **Timer**.

Switching off the TV set during recording

You can switch off the TV to standby whilst recording. The recording is continued in the standby mode.

i **Never** switch the TV set off at the mains and do **not** pull the plug of the TV set out of the socket. Otherwise the recording will be lost!

Stop recording early

You can end a current archive recording prematurely.



Press **STOP key**.

A message appears in the right upper corner of the screen.



OK Stop recording.

The recording process is ended. The portion of the TV broadcast recorded up to this point is saved on the hard disk and can be played back via the DR+ archive.

i You can also end a running recording by deleting the corresponding Timer entry in the Timer overview (see chapter **TV**, section **Timer**).

DR+ archive

With the DR+ archive you have access to all the recorded programmes and you can start their playback. In the DR+ archive you can create your own directories and sort your records accordingly.

Open the DR+ archive



Open the **DR+ archive**.



- ▼ ▲ Select the desired DR+ archive if several available.
 - OK** Display archive entries
- The bar above the selected DR+ archive shows used space on the storage medium or the still available residual capacity. Below you will find the page number (e.g. 1/4) of the entries in the DR+ archive.

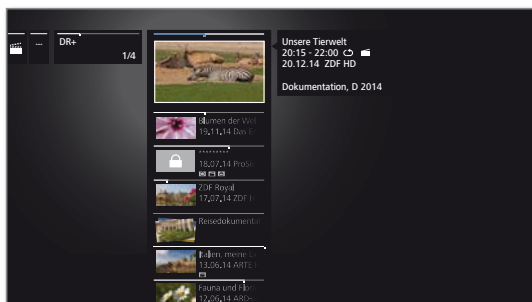

- PIP:** switch in DR+ archive view between standard and compact view. Directories in the default view are displayed by superimposed preview images and in the compact view, by an arrow -> in front of the directory name.
- The bar above the preview image or the programme name shows you how far the recording has been watched.

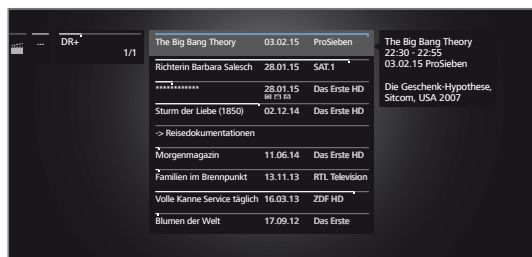

Playing from the DR+ archive



- ▼ ▲ Select the required archive entry (programme or directory).
- If directory selected:
 - ▶ Open directory.
- ▼ ▲ Select the desired broadcast in the directory.
- OK** Start or continue playback of the selected programme.

See chapter **Video**, section **Video playback** for further information.

During playback:

- P+** call next programme.
- P-** call previous programme.

i Directories are skipped in this case.



DR+ archive function list

The function list of the DR+ archive contains the individual function for its archive entries.

i The menu items available in the function list depend on the selected entry from archive (programme or directory).



▼ ▲ An archive entry has been selected.



MENU: Call function list.

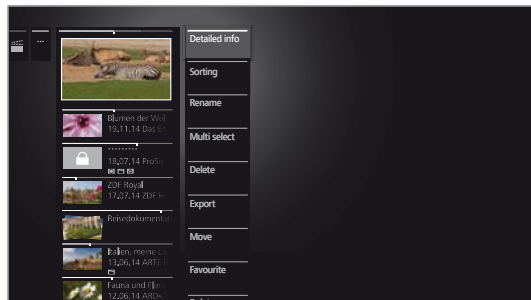

▼ ▲ Select desired function.
OK Confirm selection.

Detailed info Show detailed information on the marked archive entry (see next page).

Sorting Sort archive entries according to certain criteria (e.g. ascending A-Z or descending Z-A) or according to recording date (newest entries first).

Rename Changing title of the record or of directory.

Multi select Marking multiple archive entries is possible (see next page).

Delete Delete archive entry from hard disk and recover disk space.

Export Copy/move archive entries to an (additional) externally connected USB storage device or to the hard disk of compatible Loewe TV sets in the home network.

i If no target medium is available, the menu item is shown in dark grey.

Move Here, you can move recordings in the DR+ archive to a directory and create new directories (see chapter **TV**, section **Digital Recorder – Moving of archive entries**).

Favourite Add archive entry to **Home** favourites. See chapter **Home view** for further information.

Parental lock Protect recorded broadcast by a four digit PIN against unauthorised playback.

Symbol for the set parental lock:

i This menu item appears only when a PIN has already been defined (see chapter **System settings**, section **Control – Parental lock**).

Repeat Playing archive entry repeatedly (in a loop) during future playbacks.

Symbol for set repeat function:

Displaying detailed information on the recording

If detailed information exists on the recorded broadcast from the EPG, you can display it.

i The desired entry in the DR+ archive is marked.



MENU: Call function list.



▼ ▲ Mark **Detailed info**.
OK Display detailed information on the broadcast.

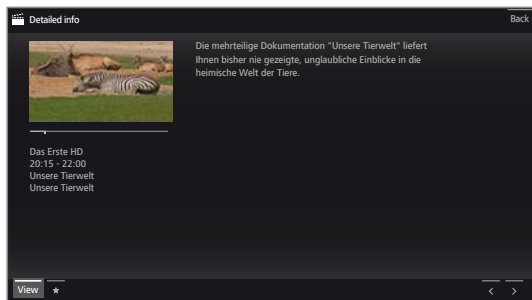

To the right of the preview image you can see a brief description of the programme content, if available.

Beneath the preview image is the progress bar that indicates how far the programme has already been viewed.

Below the progress bar, information such as station name, time and date of broadcast, as well as title of the recorded programme are given.

Changing the title of an archive recording or folder

i Desired entry (programme or folder) is highlighted in the DR+ archive.



MENU: Call function list.



▼ ▲ Mark **Rename**.
OK Call.

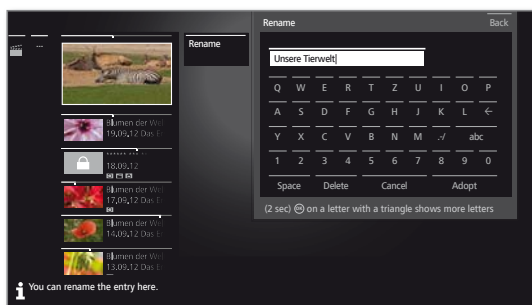

◀ ▶ ▲ ▼ Select characters.
OK Move character to input line.

i For further information on character input see chapter **General information on menu operation**.

End input with **Adopt**. This saves the change permanently.

Or:



BACK: Cancel renaming.

Multi select

Multiple selection allows to mark several archive entries and then perform a desired action via the function list (e.g. export, delete).



i The DR+ archive is opened, multiple selection was called in the DR+ archive function list.



▼ ▲ Select archive entry.
OK Confirm selection (archive entry becomes blue).
Repeat as often as desired.

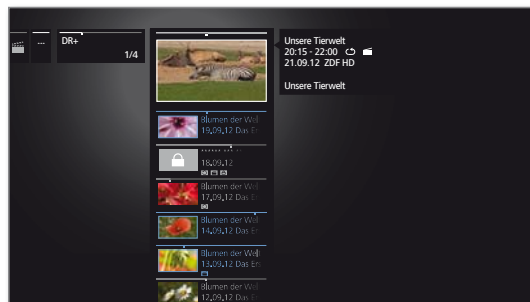

MENU: Call function list.



▼ ▲ Select desired function (e.g. delete).
OK Confirm selection.
The marked archive entries will be deleted.

Deleting recordings from the archive

i The desired entry in the DR+ archive is marked.



STOP key: Call delete dialogue.



OK Confirm deletion.
The DR+ archive will be displayed again.

Or:



MENU: Call function list.



▼ ▲ Mark **Delete**.
OK call.

OK Confirm deletion.

The DR+ archive will be displayed again.

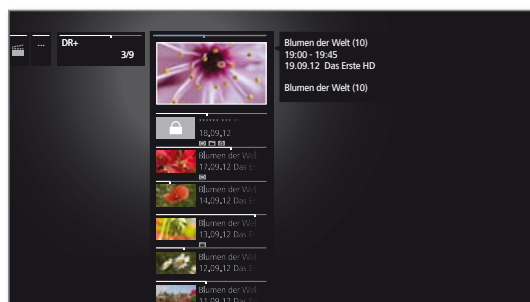

i It may take some time to delete recordings from external hard disks, depending on the length of the programme and recording quality.

i To delete a folder, all archive entries in the folder need to be deleted.

Export of archive entries

You can copy/archive entries from an externally connected USB storage device to another storage medium or to the hard disk of compatible Loewe TV sets in the home network.

- i** If no target medium is available, the menu item is shown in dark grey.
- i** Copying/moving recordings, which originate from a CI Plus encrypted station, is perhaps not possible or only to a limited extent.
- i** The desired entry in the DR+ archive is marked.



MENU: Call function list.



▼ ▲ Mark **Export**,
OK call.

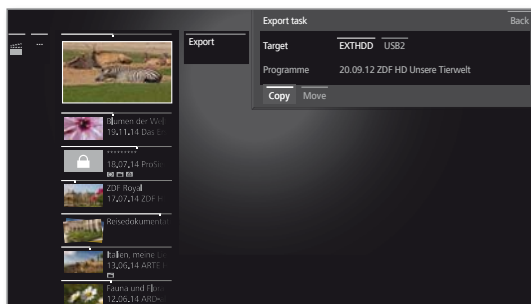

◀ ▶ Select **Target** if several are available,
OK adopt.

◀ ▶ ▲ ▼ Select **Copy** or **Move**.
OK Start the procedure.

- i** After a successful moving, the recording is automatically deleted from the source.
- i** The dubbing of archive entries takes place in the background. You see a screen message, when copying has finished. The status of copying assignments in progress/pending can be seen in the timer list.
- i** The TV set must **not** be switched off with the mains switch during the copying process!

Moving of archive entries (folder management)

In the DR+ archive, you can create new directories when using the function **move**.

Into these directories you can move existing archive entries or do a new recording directly there. For this purpose you simply choose the desired directory in the recording control (timer data).

You can determine the name of the new directory yourself. The DR+ archive root directory has the fixed designation **main directory**.

- i** It is not possible to nest several directories into one another.
- i** With multiple selection it is possible to move several archive entries simultaneously to a folder.

Moving an archive entry to a new folder

- i** The desired entry in the DR+ archive is marked.



MENU: Call function list.



▼ ▲ Mark **Move**,
OK call.

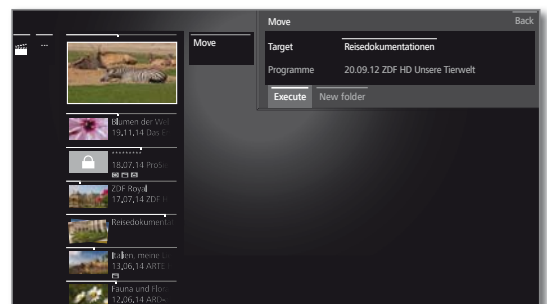

▼ ▲ Select **New folder**,
OK call.

The on-screen keyboard will be displayed to enter the folder names.

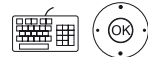

◀ ▶ ▲ ▼ Select character,
OK Move character to input line.

- i** For further information on character input see chapter **General information on menu operation**.

If the name of the folder is completely entered, complete with **Adopt**.

The new folder is created in the DR+ archive and the selected archive entry is moved into the folder.

Moving an archive entry into an existing folder

- i** Archive entry to be moved to a folder is highlighted in the DR+ archive.



MENU: Call function list.



▼ ▲ Mark **Move**,
OK call.

◀ ▶ ▲ ▼ Select **Target** (folder name) if several are available,
OK adopt.

◀ ▶ ▲ ▼ Mark **Execute**,
OK adopt.

The selected archive entry is moved to the selected folder.

Locking/unlocking a movie (Parental lock)

You can lock movies that your children are not permitted to view, for instance. Playback is then only possible after entering a PIN.

i In order to activate the Parental lock, a code number (PIN) must have been defined beforehand (see chapter **System settings**, section **Control – Parental lock**).

i The desired entry in the DR+ archive is marked.



MENU: Call function list.



▼ ▲ Mark **Parental lock**,
OK Call.

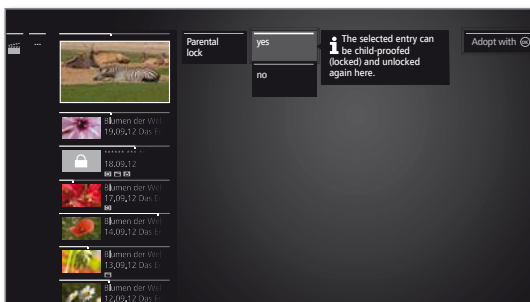

▼ ▲ Select **Yes / No**,
OK Adopt.

i The titles of locked films in the DR+ archive will be replaced by asterisks * when a parental lock is active and thus cannot be read anymore. The detailed information for the recording cannot be called up. The cover of the recording will be replaced by a picture of a lock. In addition, the entry will be labelled with the symbol

Viewing a locked movie

i The desired locked entry in the DR+ archive is marked.

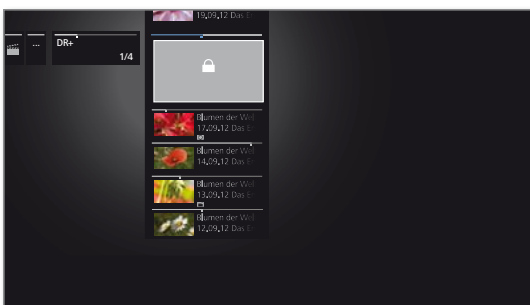

When the access code of the parental lock has not been entered yet:



OK call entry of PIN.

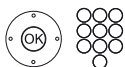

Enter your PIN.

i After the access code has been entered, the lock of the archive entries will be temporarily released.



OK View film.

DR+ Streaming

Using the DR+ streaming function you can watch movies with your TV set (DR+ Streaming Client) from other Loewe TV sets via the home network. These TV sets¹ must make their DR+ archives available in the home network (DR+ Streaming Server).

i To use DR+ streaming, at least two Loewe TV sets are required, of these, at least one TV set with integrated hard disk (with Chassis SL1xx, SL2xx, SL3xx as DR+ Streaming Server).

The TV sets also need to be connected via a network (wireless connection via Wi-Fi or cable connection via Ethernet, PowerLine).

i Archive entries can only be provided or released in the network by TV sets **with** integrated hard disks (DR+).

In case of these TV sets which are used as DR+ Streaming Servers, the DR+ archive must be made available for other TV sets:

System settings → Control → more ... → DR+ → DR+ Streaming → Share DR+ archive with other devices → yes.

i Archive entries released in the network can **be replayed** by all TV sets with chassis SL1xx, SL2xx, SL3xx and Chassis MB180.

In case of these TV sets used as DR+ Streaming Clients, access to other DR+ archives must be enabled:

System Settings → Control → more ... → DR+ → DR+ Streaming → Also use other archives → yes.

i Functions requiring write access to a device that enables the recording to be viewed are not available when viewing a DR+ archive entry over the network.

Such functions are, for example, child protection, delete protection, renaming, deleting entry or bookmark, setting bookmark, deleting or hiding parts of the recording.

Playback of DR+ archive entry via the network



Open the **DR+ archive**.



▼ ▲ Select desired archive of the corresponding device,

OK Display archive entries.

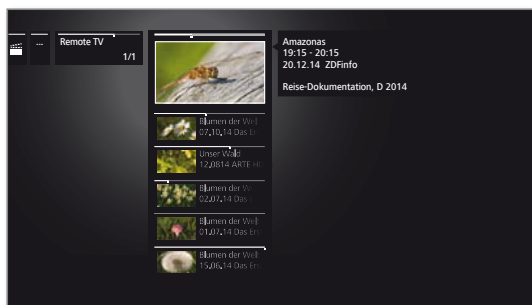

▼ ▲ Select the required archive entry,

OK Play archive entry.

See chapter **Video**, section **Video playback** for further information.

Follow-Me function

The follow me function enables you to interrupt a current programme in a TV set (main device) with integrated hard disk and to continue viewing it with your TV set (secondary device) from the point of interruption..

i To use Follow-Me function, at least two Loewe TV sets are required, of these, at least one TV set with integrated hard disk (with Chassis SL1xx, SL2xx, SL3xx).

The TV sets also need to be connected via a network (wireless connection via WLAN or cable connection via Ethernet, PowerLine).

i On the main TV set, the function must be enabled¹:

System settings → Control → more ... → DR+ → DR+ Streaming → Share DR+ archive with other devices → yes.

i On the target TV set (secondary device), the function must be enabled:

System Settings → Control → more ... → DR+ → DR+ Streaming → Also use other archives → yes.

Start Follow-Me function on main device



Press **PAUSE** key.

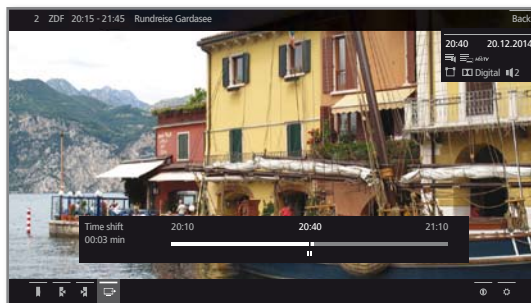

The TV image becomes a freeze frame and the DR status display appears.



▼ ▲ ◀ ▶ Activate **Follow-Me**

You will see a message on the screen.

The archive recording starts in approximately 20 seconds without an entry. The TV set switches itself off after starting the recording. The broadcast is adopted into the DR archive.

The recording TV set will make the broadcast available to the network from now.

i You can indicate the beginning of a **Follow-Me** recording at the target TV sets in your network by a screen display.

Continue viewing the programme at the second device

Call on the TV set, where you want to view the broadcast, the DR archive of the recording TV set.



Open the **DR+ archive**.



▼ ▲ Select archive of the recording TV set (main device),
▶ Display archive entries.

▼ ▲ Select Follow-Me recording,

OK View recording.

¹ Only in units **with** integrated hard disc.

Timer

In the timer menu you will find the Timer List and the Timer Services. All programmed recordings, earmarked programmes and copy jobs are listed in the timer list.

The timer services menu offers you convenient alarm services see chapter **TV**, section **Timer – Timer Services**).

Calling the timer menu



HOME: Calling the **Home** view.



◀ ▶ ▾ ▹ Select **TV**,
 ▶ ▶ ▾ ▹ select **Timer** (at sources),
OK call.

Or:



press longer: call the timer menu.



◀ ▶ ▾ ▹ Select **Timer list**.

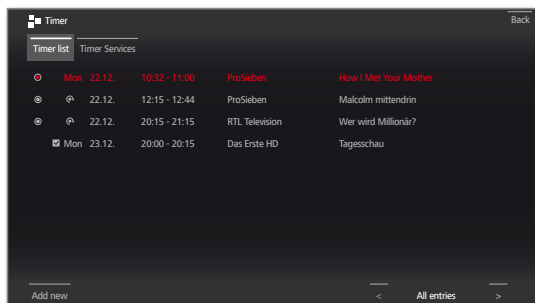

Add new You can also programme new recordings, earmark other programmes and copy pre-recorded programmes from the DR+ archive to an external USB hard disk by means of the timer list.

i When you have programmed timer recordings, the TV set can only be switched off to the standby mode. **Never** switch the TV set off at the mains and do **not** pull out the plug of the TV set out of the socket. Otherwise no timer recordings can be made.

i When a software update occurs it may happen that timer entries and memorised programmes are deleted. After such a software update, check your timer list.

Explanation of the symbols in the timer list:

- Recording
- ◐ Recording in progress
- ☑ Marked programme
- 🔄 Repeated recording (daily, weekly or Mon-Fri)
- 🔄 Serial recording

New instruction: New recording



i In the Timer list:

◀ ▶ ▾ ▹ Mark **Create newly**,
OK call.

◀ ▶ ▾ ▹ Mark **New recording**,
OK call. The function list for recording will be opened.

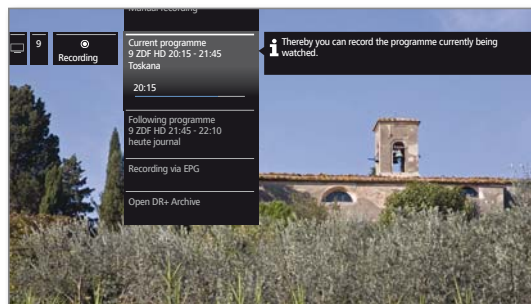

▼ ▲ Mark the desired option,
 ▶ proceed.

Manual recording Programme the recording manually.
 For further information see next side.

Current programme Record currently watched TV programme.
 For further information see next side.

i Menu item will only be indicated when EPG data are available for the current station.

Following programme Record following programme.
 For further information see next side.

i Menu item will only be indicated when EPG data are available for the current station.

Recording via EPG Programme recording of a programme via the electronic programme guide (EPG).
 For more information refer to chapter **TV**, section **EPG – Recording a programme via EPG**.

Open DR+ archive The DR+ archive of an externally connected USB hard disk is opened.

For more information refer to chapter **TV**, section **Digital-Recorder – DR+ Archive**.

New recording – Manual recording (current station)

In the Timer list, **New recording** is selected.



▼ ▲ Mark recording duration.

The selection of a recording duration programmes always a recording of the currently viewed station. For **Any station and time** see below.



OK Call **Timer data** dialogue.

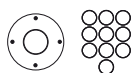

The selected recording duration is preset in the timer data. Check timer data and correct them, if required. In case of a previous selection of **??? Min**, enter definitely the recording duration.



▼ ▲ Mark **Adopt to Timer**.
 OK Confirm timer data and adopt timer instruction. Recording has been started.

New recording – Manual recording (other station)

Manual recording has been selected (see above).



▼ ▲ Mark **Any station and time**.
 OK Call **Station selection**.

◀ ▶ ▼ ▲ Mark desired station,
 OK Adopt station in timer data.

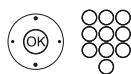

Check timer data and correct them, if required.



▼ ▲ Mark **Adopt to Timer**.
 OK Confirm timer data and adopt timer instruction.

New recording – Current programme

After calling the **Current programme** the timer data dialogue will be displayed. The current programme is preset in the timer data.

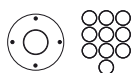

Check timer data and correct them, if required.



▼ ▲ Mark **Adopt to Timer**.
 OK Confirm timer data and adopt timer instruction. Recording has been started.

New recording – Following programme

After calling the **Following programme** the timer data dialogue will be displayed. The following programme of the current station is preset in the timer data.

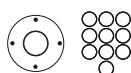

Check timer data and correct them, if required.



▼ ▲ Mark **Adopt to Timer**.
 OK Confirm timer data and adopt timer instruction.

New copy job

You should copy recordings that you want to save permanently on an external USB hard disk.

Copying recordings, which originate from a CI Plus encrypted station, is perhaps not possible or only to a limited extent.

In the Timer list:



◀ ▶ ▲ ▼ Mark **Create newly**.
 OK call.

◀ ▶ ▲ ▼ Mark **New copy**.
 OK call.

The DR+ archive will be called. For further information for exporting archive entries refer to chapter **TV**, section **Digital-Recorder – Export of archive entries**.

Record conflict

When programming a new recording, it can happen that there will be an overlapping with already stored timer recordings. In this case, the **recording conflict** dialogue will open.

Here you can determine which of the recordings you want to be executed, and you must eventually specify which of the programmes shall be fully recorded and which are cut.



▲ ▼ Select recording,
 OK change status.

The symbol before the recording shows you what happens to the recording.

If the status for each recording is ok:



▲ ▶ ▲ ▼ Mark **store recordings**.
 OK call.

The timer data of the recordings will be adjusted accordingly.

Explanation of the symbols in the conflict manager:



TV programme is completely recorded.



Recording is cut off (at the beginning and/or end). Pay attention to the start and end time of the recording.



The recording is deleted.

Delete/change programmed timer instruction

Use this function in the timer list if you want to delete recordings already programmed, to end a running timer recording or to change a timer instruction.

i The Timer list is displayed.



▼ ▲ Mark desired timer instruction.

i The text of a currently active timer instruction is red. If you delete this timer instruction, the recording is stopped.

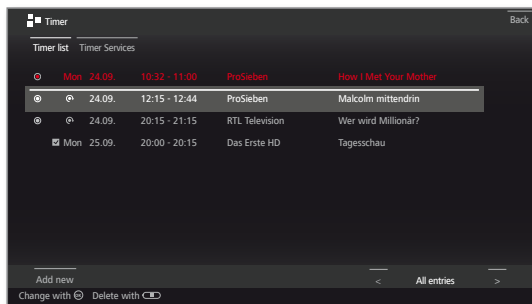

OK Change marked timer instruction.
 The timer instruction will be displayed.

Or:



STOP: Delete marked timer instruction.



OK Confirm delete.
 Timer instruction will be deleted.

Entering the Timer data

After selecting the station you wish to record, timer data will be displayed.

The setting options for the timer data differ depending on the way (EPG, manually) the recording has been programmed.



▲ ▼ ◀ ▶ Update **timer data**, if required, or press **OK** for confirmation.

i Please also read the instructions in chapter **System settings**, section **Extras – CA module** concerning the recording of encoded programmes.

Explanations of the setting options in the menu Timer data – Standard settings

- Folder If available, select the directory into which the recording will be directly saved. The DR+ archive root directory has the fixed designation **Main folder**.
 Default setting: Main folder.
- Station Station for which the recording is carried out.
- Date Day of recording.
- Beginning Starting time of the recording.
- End End time of the recording.
- Recording type Programmes can be recorded in different ways:
Once only: The programme will be recorded at the specified time.
Mon-Fri: The programme will always be recorded from Monday to Friday at the specified time.
Daily: The programme will be recorded every day at the specified time.
Weekly: The programme will be recorded every week at the specified time.
Serial ¹: A programme running regularly, but with different start times, can be conveniently programmed. In this case, the TV set is checking every day at the specified time, whether the programme is available in the EPG data. If so, the program is recorded, if not, the next review will be made the following day.

¹ only available if EPG data exists.

Explanations of the setting options in the menu **Timer data – Additional options**

Lock recording Only allow later playback of this recording after entering the PIN number (Parental lock).

i If a PIN still has not been entered under **System settings → Control → Parental lock**, the **Parental lock** will at first be activated. See chapter **System settings**, section **Control – Parental lock** for further information.

Delete protection Safeguard the recording from being deleted automatically by using the delete manager.

Auto time control¹ Your TV set can use the automatic time control (Accurate Recording) for recording a programme. The **automatic time control** takes control of the corresponding monitoring of the start and end time for DVB stations. The recording is started at the beginning of the broadcast and switched off at the end, even if the start and/or end time have been changed by the programme provider.

i The automatic time control is not supported by all stations.

i If **yes** is selected and automatic time control is **not** supported by the recorded channel then **no** recording is made.

i If the programme information (Event-ID) should not be available any more for the recording of a programmed broadcast. e.g., due to a programme change or because the Event-ID has been changed by the station, the programme **cannot** be recorded. The broadcasters alone are responsible for the transfer of this data for using **automatic time control**. The availability of the appropriate data cannot be guaranteed by Loewe.

Recording subtitles Select whether broadcast subtitles are to be recorded too.

i In case of a **direct recording** the presetting is taken from **System settings → Control → more ... → DR+ → Recording subtitles**.

Favourite When selecting **yes** the recording will be added to the **Home** favourites.

Timer Services

This menu offers you convenient alarm services. Programmed alarms are also active when the TV set has been switched off to standby. If the TV set is switched on from the standby mode by alarm, a screen message appears. If this is not confirmed within 5 minutes with the **OK key**, the TV set switches automatically off again for safety reasons. The TV set can also be switched off automatically at certain times. A screen warning appears one minute before automatic switch off. The automatic switch off can be interrupted by pressing any key.

Call Timer Services

HOME

HOME: Calling the **Home** view.



◀ ▶ ▾ ▹ Select **TV**,

◀ ▶ ▾ ▹ select **Timer** (at sources),
OK call.

Or:

DR+

press longer: call the timer menu.



◀ ▶ ▾ ▹ Select **Timer Services**.

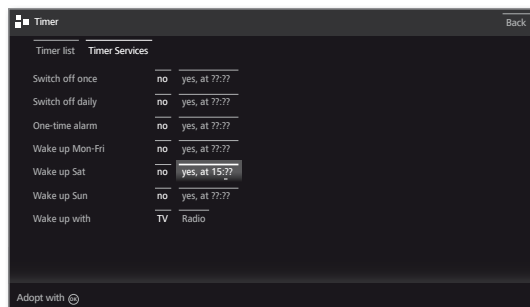

◀ ▶ ▾ ▹ Select the desired setting,
OK change.

OK adopt.

Explanations of the setting options:

Switch off once The set switches to the standby mode automatically at the specified time. If a time is specified which has already passed on the same day, the set switches off at this time the next day.

Switch off daily The set switches to the standby mode automatically every day at the specified time.

One time alarm The set alerts you once today at the specified time. If a time was specified which has already passed on the same day, the alarm is saved for the next day.

Wake up Mon-Fri The set regularly alerts you from Monday to Friday at the set time.

Wake up Sat The TV set alerts on Saturdays or Sundays regularly
Wake up Sun at the specified time.

Wake up with Indicate whether the TV set should enter the **TV** or **radio** mode from stand-by during an alarm. The station, which was last active, is activated.

¹ only available if EPG data exists.

Video

The item **Video** gives you access to videos from local (USB, home network) and online sources.

i High definition movie material (HD movies) from format 720p upwards (resolution 1280 x 720 or higher) should be played back via a **wired** connection. If there is a **wireless** connection, then technical limitations (e.g., fault liability, bandwidth limitations) can cause disruptions in the playback right up to a complete breakdown of the playback.

Calling video selection



HOME: Calling the **Home** view.



◀ ▶ ▾ ▹ Select **Video**.

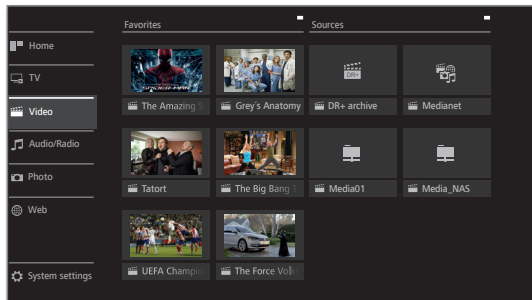

◀ ▶ ▾ ▹ Select favourite (if any) or source, **OK** call.

Possible video sources

i The media sources shown here depend on the devices available/used.

DR+ archive Programmes that you have recorded on an external hard disk with USB connection using the Digital Recorder are compiled in the **DR+ archive**. Via the DR+ archive you can replay, edit or delete your recorded programmes.

For further information see chapter **TV**, section **Digital Recorder – DR+ archive**.

MediaNet Call **MediaNet**.

For further information see chapter **Web**, section **MediaNet**.

USB USB storage media on the USB connections of your TV set. The exact designation depends on the relevant storage medium.

i Please also observe the notes regarding USB sticks in chapter **Miscellaneous**, section **Software update!**

Video function list

The video function list contains the individual functions for your videos.

i A video source has been selected.

i The menu items available in the function list depend on the currently marked object (data source, directory, file).



MENU: Call function list.

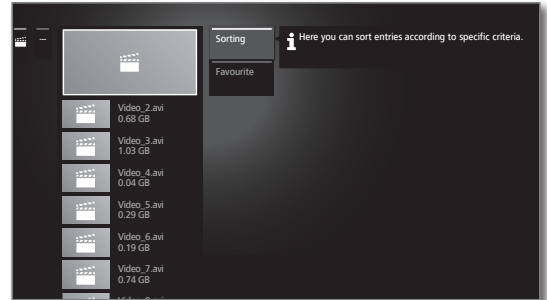

◀ ▶ Select desired function, **OK** confirm selection.

Sorting Sort media files in the opened directory in alphabetical (ascending A-Z or descending Z-A) order, file size or date (newest entries first).

Favourite Add marked media file to the **Favourites** in Home view.

Select video

i A video source has been selected.

i The directory structure and the form of presentation of the title selection is dependent on the selected source.



◀ ▶ Select desired directory, **OK** open directory. Repeat procedure if necessary.

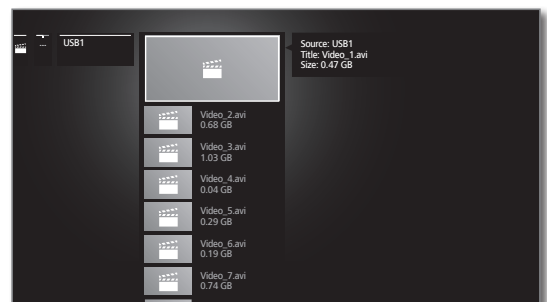

◀ ▶ Select desired video, **OK** start or continue playback of the selected video. See chapter **Video**, section **Video playback** for further information.

Video playback

The description of the following functions applies to the playback of videos from the DR+ archive as well as for videos from USB storage media or from media servers in the home network.

i For playback of DR+ archive entries you have additional playback and editing capabilities. The explanation of these functions you find in chapter **Video**, section **Additional functions for DR+ archive playback**.

Video status display

The video status display provides you with further options for the current playback.

INFO

INFO: Show status display.



BACK

BACK: Hide the status display again.

Description of the symbols in the status display for video playback

i The number of available symbols in the status display depends on the selected video and the video source (DR+ archive, USB, home network).

| Symbol (icon) | Remote control key | Description |
|---------------|--------------------|--|
| | BACK | Call list view (select video). |
| | long | Set bookmark manually. i Only for playback from DR+ archive. |
| | long | Delete bookmark manually. i Only for playback from DR+ archive. The function is only available when a manually set bookmark is within five seconds around the current playback position. |
| | | Skip to next bookmark. i Only for playback from DR+ archive. |
| | | Skip to previous bookmark. i Only for playback from DR+ archive. |
| | - | Call dialogue for deleting bookmarks. i Only for playback from DR+ archive. |

| Symbol (icon) | Remote control key | Description |
|---------------|--------------------|--|
| | - | Start DR+ Follow-Me recording. The Follow-Me function enables you to interrupt a current programme and to continue viewing at an alternative TV set from the point of interruption. i Only in time-shift mode. |
| | - | Call interval functions. i Only for playback from DR+ archive. i Only selectable in pause mode. |
| | - | Adopt current freeze picture as cover for the DR+ archive. i Only for playback from DR+ archive. i Only selectable in pause mode. |
| | - | Activate / deactivate again the repetition of the currently played archive entry. i Only for playback from DR+ archive. |
| | - | Switch repetition (loop playback) of all titles of the current directory ON/OFF. i For playback of videos from USB storage media or from the home network. |
| | - | Switch ON/OFF repetition (loop playback) of the current title. i For playback of videos from USB storage media or from the home network. |
| | - | Change picture format of the video playback. |
| hh:mm | - | Skip to desired position in the playback. |
| | | Add currently played video to the favourites in Home view. |
| | INFO | Call detailed info on the current playback. i INFO key: display of detailed info when status display appears, otherwise call of status display. |
| | MENU | Call function list with video settings. |

Explanation of keys

- INFO** **INFO** (press longer): show Explanation of keys.
- INFO** **BACK** **INFO** or **BACK**: hide Explanation of keys

Pause playback (freeze picture)

 **PAUSE key:** Switch to freeze picture.

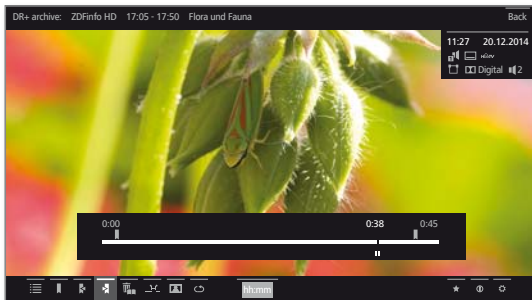

 **PLAY key:** Continue playback.

Jump

By briefly pressing the **◀** or **▶** keys you can skip forwards and backwards in the movie.

The jump distance is adjustable in the **System settings** under **Control → more ... → DR+ → Jump distance** (see also chapter **System settings**, section **Control → DR+**).

 **▶▶ Skip forwards.**

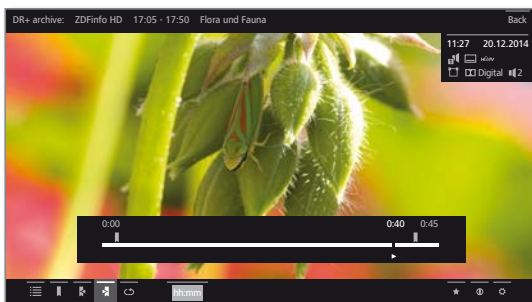

 **◀◀ Skip backwards.**

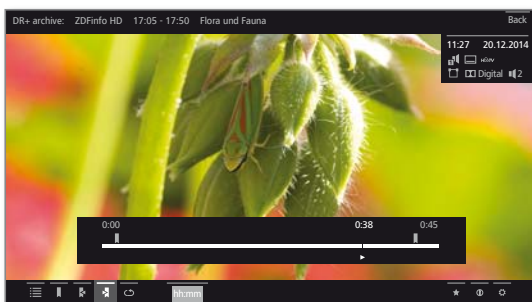



Skipping with Smart jump

The **Smart jump** function ensures that the jump width is halved each time the jump direction is changed or doubled after three jumps in the same direction (max. 8 minutes). This way you can quickly find a certain spot of the recording.

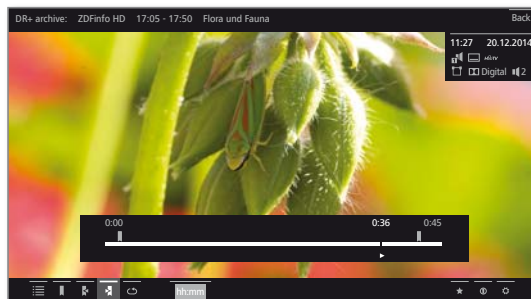
The settings for Smart jump you find in the **System settings** under **Control → more ... → DR+ → Smart jump**.



You are looking for a particular scene in a running programme:

  Depending on your needs, press the key **◀◀** (backwards) or **▶▶** (forwards) briefly several times, to roughly jump to the area of the programme you are looking for.

If you skipped the desired scene of the programme, jump in the opposite direction. This jump is executed in halves of the jump distance.

If you skipped the desired scene of the programme again, jump again in the opposite direction. In the process, the jump distance is cut in half again.

By halving the jump distance again when changing direction you can gradually approach the desired location.

Jump by entering a time

You can jump to any position in the video by entering a time.



▲ ▼ Show status bar.

▼ ▲ ◀ ▶ mark **hh:mm (Jump to ...)**.

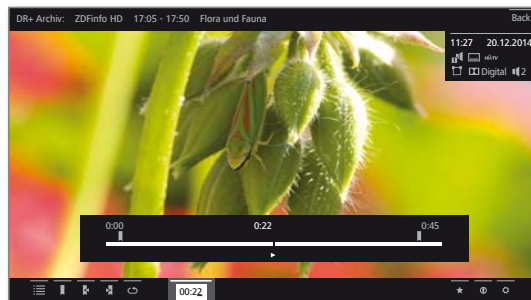

Enter the desired time with the **numerical keys**.





OK Execute jump.

Wind

To search for desired scenes in movies you can fast forward and rewind at three different speeds. Sound is not audible during winding.

  **◀** or **▶** press a little bit longer.



  By each brief pressing of **◀** or **▶** the speed will increase until you switch back to the first speed.



The different winding speeds are represented by the symbols shown below.

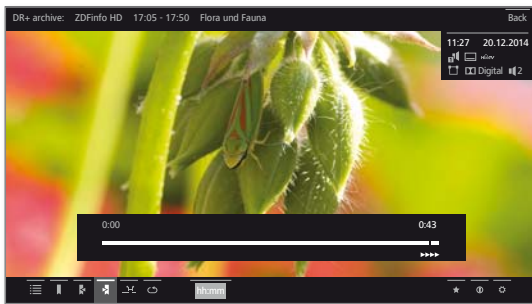

i In case of time-shift viewing, playback is automatically activated when the end of the recording is reached. You are then about 10 seconds behind the live picture or when rewinding at the beginning of the time shift recording.

i In case of Fast forward of archive entries, playback will finish at the end of the recording. The DR+ archive is displayed again.



PLAY key: Continue playback.

i In the case of Internet videos, please wait until these are buffered in the memory. This can take a few seconds, depending on the bit rate of the film and Internet speed.

Repeat

Videos can be repeated, i.e., replayed in an endless loop. Depending on the source (DR+ archive, USB storage medium, media server in the network), single or all videos can be replayed in an endless loop.

Repeated playback of DR+ archive entries



INFO: Show status bar.



◂ ◃ ◅ ◆ Mark **Repeat** 
OK confirm.

The current archive entry will be replayed repeatedly. The repetition setting remains active for this archive entry even when the playback is finished.

To deactivate playback again:



◂ ◃ ◅ ◆ Mark **Repeat off** 
OK confirm.

Repeating videos from USB storage media or media servers



INFO: Show status bar.



◂ ◃ ◅ ◆ Mark **Repeat title** 
OK Switch the repetition of the individual video ON/OFF.

i The repeat setting remains until it will be deactivated or another video is replayed.

Or:



◂ ◃ ◅ ◆ Mark **Repeat all** 
OK Switch repetition of all titles of the current directory ON/OFF.

i The repeat setting remains until it will be deactivated or another directory in the overview is selected.

i **Repeat title** and **Repeat all** cannot be activated simultaneously. Using one of the two functions deactivates the respective other one.

Select language/sound

Videos, especially those recorded from TV broadcasts, can contain several sound tracks.

Select sound track/language:



INFO: Show status bar.



▼ ▲ ◀ ▶ Mark **Settings** 
OK Call settings.

▼ ▲ Mark **Language/sound**,
OK call Language/Sound selection.

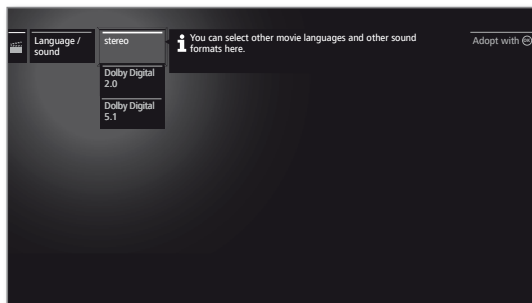

▲ ▼ mark desired sound or desired language,
OK select sound track.

Changing the picture format

i Function is not available for all videos.



INFO: Show status bar.



▼ ▲ ◀ ▶ Mark **Change Picture format** 
OK set picture format.

You can choose between small or full image settings. Small image setting shows the video close to the original resolution. The video status bar is permanently shown below the image.

The full image setting enlarges the image to fit the entire screen. The status bar can be set to visible or hidden.

Additional functions for DR+ archive playback

There are additional editing and playback functions for playback of recorded programmes from the DR+ archive of an externally connected USB hard disk.

Setting bookmarks

To retrieve interesting scenes in a movie later, you can manually set the bookmarks. In addition, there are also automatically set bookmarks for the start/end of a programme.

In programmes sent in Dolby Digital 5.1 format, the commercials are detected and automatically bookmarked at the beginning and end of the advertising block.

In case of a running time-shift recording (timeshift television), this will be converted into an archive recording when a blank is set.



PLAY key (press longer): Set bookmark.

You will see a message on the screen. The status bar is then faded in and you will see the set bookmark above the bar for the playback.

i Automatically set bookmarks are white. Manually set bookmarks are blue.

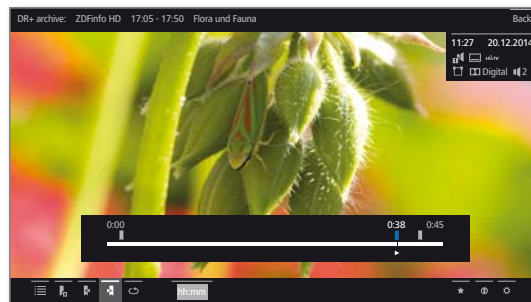

Jumping to Bookmarks



INFO: Show status bar.



◀ ▶ ▶ ▲ Mark next bookmark 
OK Jump to next bookmark.

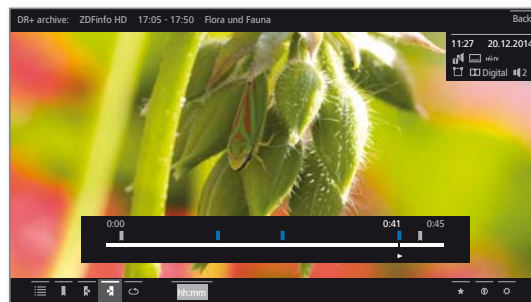

◀ ▶ ▶ ▲ Mark previous bookmark 
OK Jump to next bookmark.

Or:



Blue key: Skip to next bookmark.



Gellow key: Skip to previous bookmark.

Deleting individual bookmarks

Jump to the manually set bookmark to be deleted.

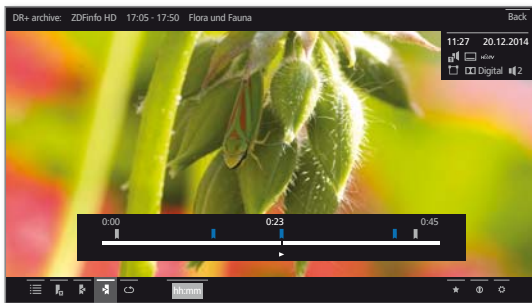

Press **PLAY** key for a little bit longer: Delete bookmark.

Deleting the Bookmark during playback

You can delete your manually set bookmarks during the playback of the DR+ Archive entry.

i Manually set bookmarks are blue, automatically set bookmarks are displayed in grey. Automatically set bookmarks cannot be deleted.



PAUSE key: Switch to freeze picture.



▼ ▲ ◀ ▶ Mark **Delete bookmark** 
OK call delete dialogue.

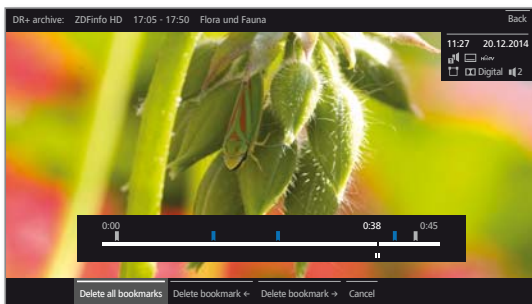

Delete all bookmarks All manually set bookmarks (blue) in the current recording are deleted.

Delete bookmark ← The manually set bookmark to the left of the current position will be deleted.

Delete bookmark → The manually set bookmark to the right of the current position will be deleted.



OK Confirm selection.



PLAY key: Continue playback.

Interval functions

The intervals between manually or automatically set bookmarks (intervals) can be faded out for future playbacks. In addition to that, unwanted intervals at the beginning or end of your recorded broadcast can be deleted.

i An archive entry is replayed.



INFO: Show status bar.

Move to the desired interval in the recorded broadcast by skipping or winding.



PAUSE: Stop play.

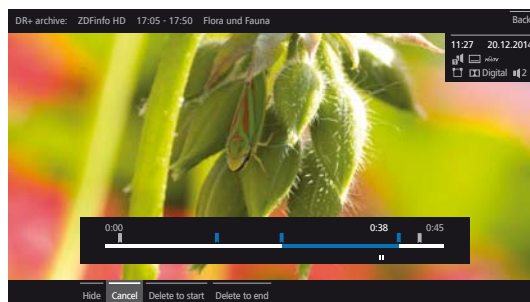

◀ ▶ ▲ ▼ Mark **Interval functions** 
OK Call interval functions.

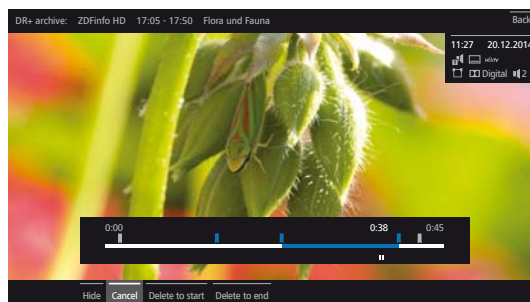

Hiding intervals

i The **Interval functions** are activated.



◀ ▶ mark **Hide**.
OK hide current interval.

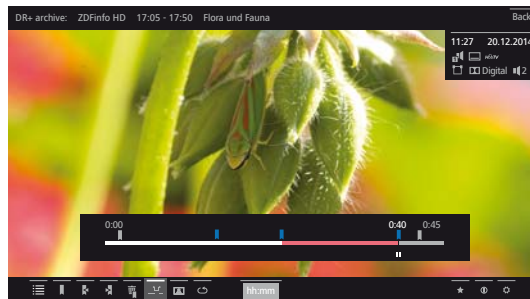

This interval will be skipped when the archive entry is replayed in the future.

Show hidden sections

A screen message will appear when a hidden section is skipped during replay of a DR+ archive entry.

i In **System settings** → **Control** → **more ...** → **DR+** → **Notify hidden sections** → **yes** must be selected.



◀ ▶ When message appears on screen, select **yes**, **OK** confirm.

During future replays, the hidden section is displayed again.

Deleting part of the recording

i An archive entry is replayed.



INFO: Show status bar.



Press **PAUSE key** at such a position from which the recording shall be deleted up to the beginning or to the end.

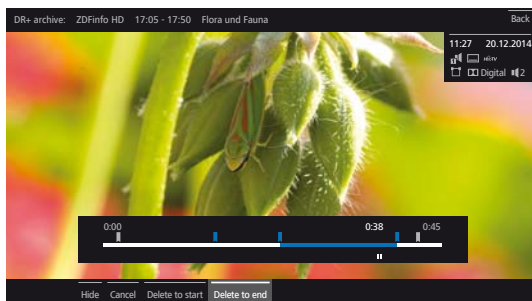

◀ ▶ ▼ ▲ Mark **Interval functions** **1-f**, **OK** Call interval functions.

◀ ▶ Mark **Delete to start** or **Delete to end**, **OK** confirm.

◀ ▶ Mark **Confirm delete**, **OK** Delete part of recording.

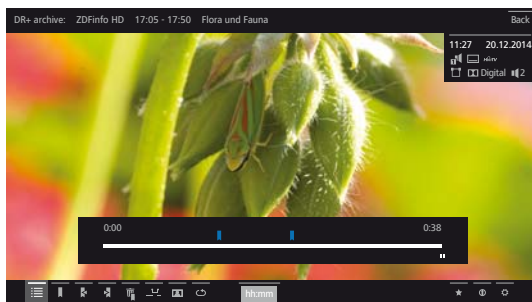

Determine cover picture

The covers for the display of the entry in the DR+ archive can be freely determined by you during an archive replay:



Jump / wind to the desired position in the recording.



PAUSE key: Switch to freeze picture.



▼ ▲ ◀ ▶ Mark **Adopt as cover picture** , **OK** confirm.

You will see a message on the screen. The image will be displayed next to the broadcast in the DR archive in future.



PLAY key: Resume play.

Subtitles

When recording a programme, any existing subtitles can be recorded as well and displayed when playing back.

i An archive entry is replayed.

i Subtitles were recorded too (see chapter **TV**, section **Timer – Entering the Timer data**).



INFO: Show status bar.



▼ ▲ ◀ ▶ Mark **Settings** , **OK** call settings.

▼ ▲ Mark **Subtitles**, **OK** call up available subtitles.

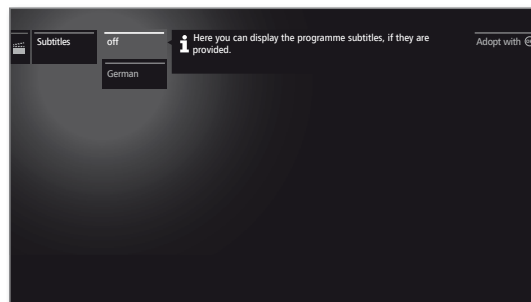

▼ ▲ Mark the desired subtitles, **OK** show/hide subtitles.

Deleting intervals

Defined intervals will be deleted when you delete the corresponding bookmark at the beginning or the end of the interval.

Audio/Radio

With item **Audio/Radio** you find music files from your USB storage media and media servers in the home network and you access DVB and Internet radio.

Calling Audio selection

HOME

HOME: Call the **Home** view.



◀ ▶ ▾ ▹ Select **Audio/Radio**.

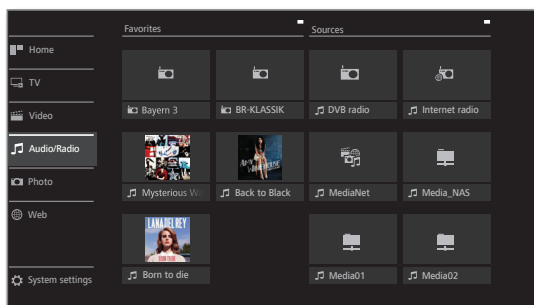

◀ ▶ ▹ ▸ Select favourite (if any) or source, **OK** call.

Possible Audio/Radio sources

i The media sources shown here depend on the devices available/used.

DVB radio The TV set can receive digital radio stations via DVB. For further information see chapter **Audio/Radio**, section **Radio mode (DVB radio)**.

Internet radio The TV set can receive digital radio stations via the Internet. For further information on Internet radio see chapter **Audio/Radio**, section **Radio mode (Internet radio)**.

MediaNet Call **MediaNet**. For further information see chapter **Web**, section **MediaNet**.

USB USB storage media which are connected to the USB of your TV set. The exact designation depends on the relevant storage medium.

i Please also observe the notes regarding USB sticks in chapter **Miscellaneous**, section **Software update!**

WMP11 Examples for media servers in your home network. The exact designation depends on the media server used.

Audio/Radio function list

The audio/radio function list contains the individual functions for your music titles.

- i** An audio source has been selected.
- i** The menu items available in the function list depend on the currently marked object (data source, directory, file).

MENU

MENU: Call function list.

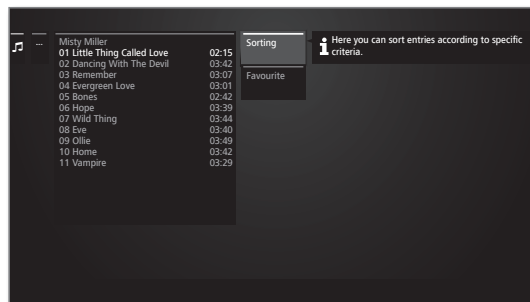

▼ ▲ Select desired function, **OK** Confirm selection.

Sorting Sort media files in the opened directory in alphabetical (ascending A-Z or descending Z-A) order, file size or date (newest entries first).

Favourite Add marked media file to the **Favourites** in Home view.

Select music title

- i** An audio source has been selected.
- i** The directory structure and the form of presentation of the title selection is dependent on the selected source.



▼ ▲ Select desired directory, **OK** open directory. Repeat procedure if necessary.



▼ ▲ Select desired music title, **OK** Start or continue playback of the selected music title.

See chapter **Audio**, section **Audio playback** for further information.

Audio playback

Description of the symbols in the status display for audio playback

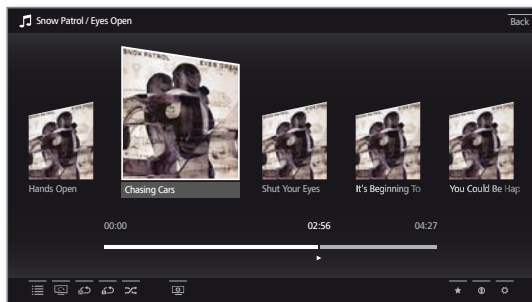

| Symbol | Remote control key | Description |
|--------|--------------------|--|
| | | Call Folder view (select music title / station). |
| | — | Switch repetition (loop playback) of all titles of the current directory ON/OFF. (Repeat all) i Only for playback of music titles via USB / Home network. |
| | — | Switch ON/OFF repetition (loop playback) of the current title. (Repeat title) i Only for playback of music titles via USB / Home network. |
| | — | Switch Shuffle playback for the titles of the current directory ON/OFF. i Only for playback of music titles via USB / Home network. |
| | | Switch off the TV screen. |
| | | Add the current station / music title to the favourites in Home view. |
| | | Show EPG detailed info on the current broadcast. i Only for DVB radio. |
| | | Call detailed info on the played music titles. i Only for playback of music titles via USB / Home network. |
| | | Call function list with audio settings. |

Explanation of keys

- INFO** (press longer): show Explanation of keys.
- INFO** or **BACK**: hide Explanation of keys.

Pause playback

- PAUSE key:** Stop current playback.

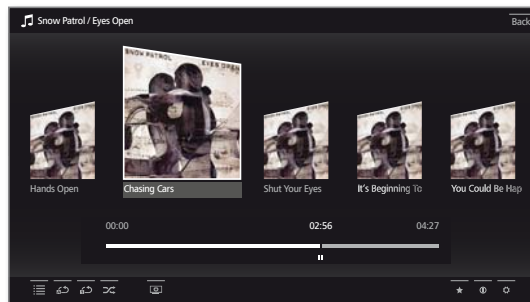

- PLAY key:** Continue playback.

Wind

You can fast forward music titles at four different speeds. Sound is not audible during winding.

- Press **▶▶** a little bit longer.

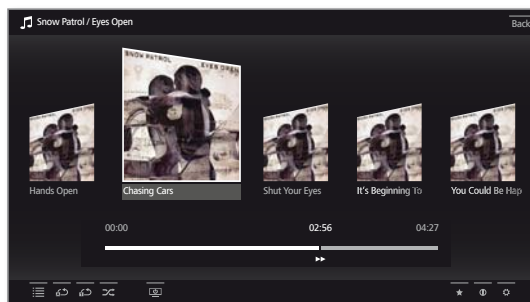

With each brief pressing of **▶▶** the speed will increase until you switch back to the first speed. Available speeds: 2x, 4x, 8x, 16x.

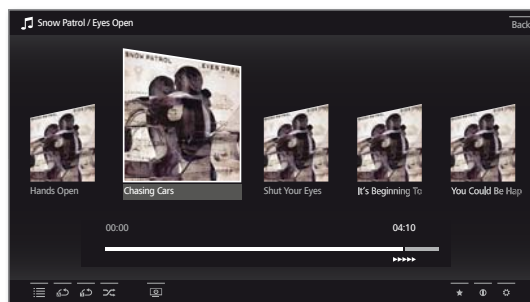

- PLAY key:** Continue playback.

Select another title / play current title from start



BACK: Call music selection.

Select music title as described in chapter **Audio/Radio**, section **Selecting music titles**.

Or:



Press **P+** or **▶▶** briefly:
Play next title of current album / directory.



Press **P-** or **▶▶** briefly:
Play current title from start.

Press **P-** or **▶▶** briefly again:
Play previous title of the current album / directory.

Or:



▲ ▼ Go to line with music titles,
◀ ▶ scroll in music titles.

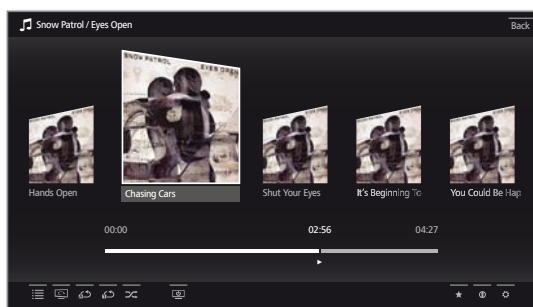

OK Start playback of the marked title.

Repeat

Music titles can be repeated, i.e., replayed in an endless loop.



▼ ▲ ◀ ▶ Mark **Repeat title**

OK Switch the repetition of the individual music title ON/OFF.

i The repeat setting remains until it will be deactivated or another music title is replayed.

Or:



▼ ▲ ◀ ▶ Mark **Repeat all**

OK Switch repetition of all music titles of the current directory ON/OFF.

i The repeat setting remains until it will be deactivated or another directory in the overview is selected.

i **Repeat title** and **Repeat all** cannot be activated simultaneously. Using one of the two functions deactivates the respective other one.

i **Repeat** and **Shuffle** (see right column) cannot be activated at the same time. Activating a repeat operation deactivates shuffle.

Shuffle playback

The music titles of your current medium are replayed in random order.



▼ ▲ ◀ ▶ Mark **Shuffle** playback

OK Switch shuffle playback of the titles in current album / directory ON/OFF.

i **Repeat** and **Shuffle** (see left column) cannot be activated at the same time. Activating the shuffle playback deactivates repeat.

Switching the screen ON/OFF



Green key: Switch screen OFF.

Or:

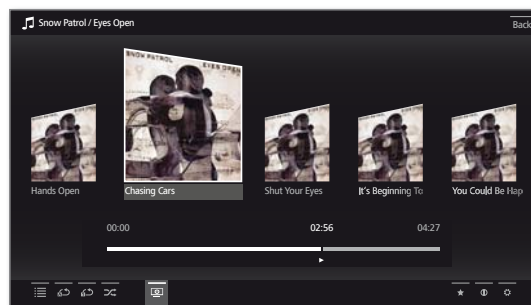

▼ ▲ ◀ ▶ Mark **Screen off**

OK Switch screen off.

i Switching off the screen reduces the power consumption of the TV set.

Switch on the screen with the remote control:



Press **green key**.

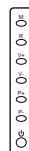

Switch on the screen on the TV set:

Press **R** on the local control panel on the TV set.

Ending playback



STOP key: End playback and return to music selection.

Radio mode (DVB radio)

The TV set can receive digital radio stations via DVB.

i The **AUDIO key** has been preset to radio mode in the factory.

Switching Radio mode on



AUDIO key on the remote control.
The last used radio mode (DVB or Internet) is called.

Or:



HOME: Calling the **Home** view.



◀ ▶ ▾ ▹ Select **Audio/Radio**.

◀ ▶ ▾ ▹ Select **DVB radio**,
OK call.

For the first use of DVB-Radio the first station in the radio station list is called, otherwise the station last used.

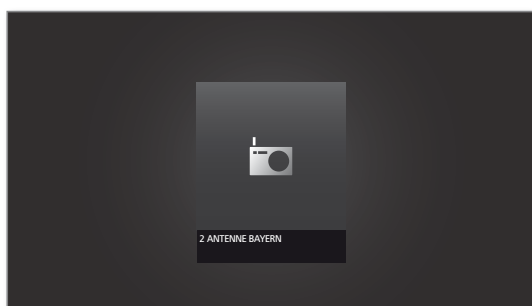

i Certain radio stations show instead of the above symbol, a station logo.

Station switching

i The radio mode is switched on and a radio station has been selected (see above).



P+/P- Station up/down.
The number and the station name are displayed briefly. Also, the status display with time/date and programme-dependent symbols appears.

Or:



Enter the station directly using the **numerical keys**.

Or:



OK call station list.

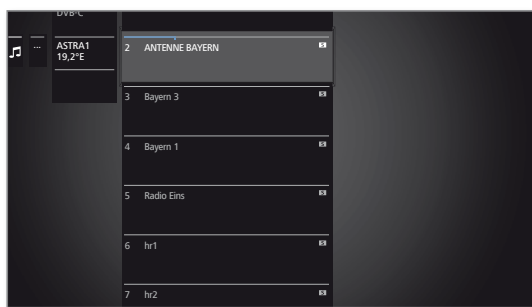

▾ ▹ Select station,
OK call.

Explanation of keys



INFO (press longer): show Explanation of keys.

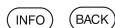

INFO or **BACK:** hide Explanation of keys.

DVB radio function list



MENU: Call function list.

Or:



OK Call station list,
▶ call function list.

▴ ▾ Select function,
OK call.

See chapter **TV**, section **Function list** for further information.

HbbTV services for DVB radio

Various DVB radio stations also offer HbbTV text/media text. The functionality is the same as in TV mode. (see chapter **TV**, section **HbbTV / MediaText**).

Switching the screen on/off



Green key: Switch screen OFF.

i Switching off the screen reduces the power consumption of the TV set.

Switch on the screen with the remote control:



Press **green key**.

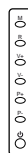

Switch on the screen on the TV set:

Press **R** on the local control panel on the TV set.

Exit radio mode



Press **AUDIO key** or



TV key: TV mode is called.

Or:



HOME: Calling the **Home** view.



◀ ▶ ▾ ▹ Select another operating mode,
OK call.



Radio mode (Internet radio)

The TV set can receive digital radio stations via the Internet.

i The names of the directories and stations in the Internet radio mode are given by the provider vTuner. Changing the order of stations or renaming them is not possible here.

i Internet radio is only accessible if a connection to the Internet has been established.

Switching Radio mode on



AUDIO key on the remote control.
The last used radio mode (DVB or Internet) is called.
Or:



HOME: Calling the **Home** view.



◀ ▶ ▾ ▹ Select **Audio/Radio**.

◀ ▶ ▾ ▹ Select **Internet radio**.
OK call.

You see the radio station list.

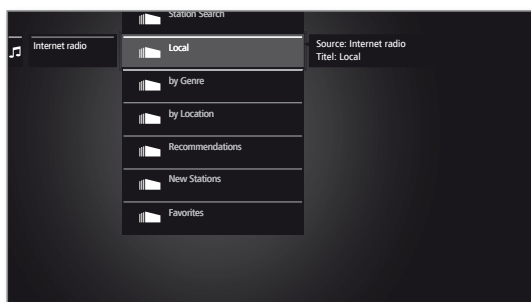

▾ ▹ Mark desired directory,
OK open directory. Repeat procedure if necessary.

▾ ▹ Select station,
OK call.

i For further information on the control of the Internet radio see chapter **Audio/Radio**, section **Audio playback**.

Station switching



BACK: call station list.

Select stations as described above. Or:



P+/P- Scroll through the current Internet radio directory to look for stations. Or:



Keys 2-9: Input the first letter. The station list will jump to the first station of the corresponding letter.

Explanation of keys



INFO (press longer): show Explanation of keys.



INFO or **BACK:** hide Explanation of keys.

Internet radio function list



MENU: Call function list.



▴ ▾ Select function,
OK call.

See chapter **TV**, section **Function list** for further information.

Artist Search (Search for artists)

By means of the search for artists, you can quickly and easily see all radio stations that just play music by this artist. The result list is sorted for **now** and **most played**.



i Internet radio station list is opened.

▾ ▹ Select search for artists,
OK on-screen keyboard is opened.

◀ ▶ ▾ ▹ Enter name of the band or singer using the keyboard (see also chapter **General information on the operation**, section **Entering characters with on-screen keyboard**),
OK adopt, search is started.

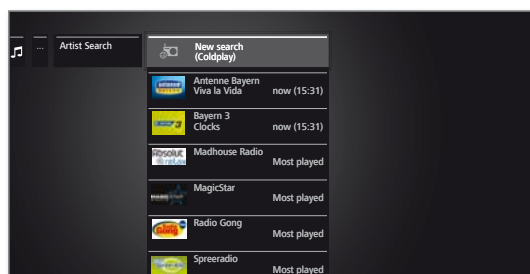

▾ ▹ Select station,
OK call.

Station search

You can search an Internet radio station directly by name using the menu item Station search. The procedure is similar to the Artist Search described above.

Switching the screen on/off



Green key: Switch screen OFF.

Or:

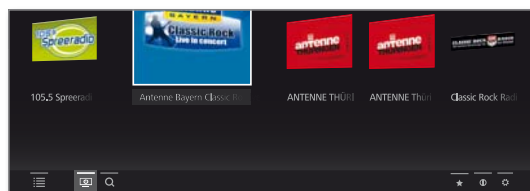

▾ ▹ Select **Screen off** ,
OK Switch screen off.

i Switching off the screen reduces the power consumption of the TV set.

Switch on the screen with the remote control:



Press **green key**.

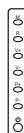

Switch on the screen on the TV set:

Press **R** on the local control panel on the TV set.

Exit radio mode



TV key: TV mode is called.

Or:



HOME: Calling the **Home** view.



◀ ▶ ▾ ▹ Select another operating mode,
OK call.

Photo

Via menu item **Photo** you can view photos from your local media and from online sources on your TV screen.

Calling Photo selection



HOME: Calling the **Home** view.



◀ ▶ ▾ ▴ Select **Photo**.

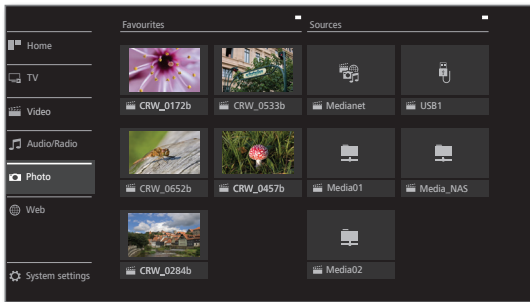

◀ ▶ ▾ ▴ Select favourite (if any) or source,
OK call.

Possible photo sources

i The media sources shown here depend on the devices available/used.

MediaNet Call **MediaNet**.

For further information see chapter **Web**, section **MediaNet**.

USB USB storage media on the USB connections of your TV set.
 The exact designation depends on the relevant storage medium.

i Please also observe the notes regarding USB sticks in chapter **Miscellaneous**, section **Software update!**

Photo function list

The photo function list contains the individual functions for your photos.

- i** A photo source has been selected.
- i** The directory structure and the form of presentation of the photo selection is dependent on the selected source (example of a menu image: source server home network).
- i** The menu items available in the function list depend on the currently marked object (data source, directory, file).



MENU: Call function list.

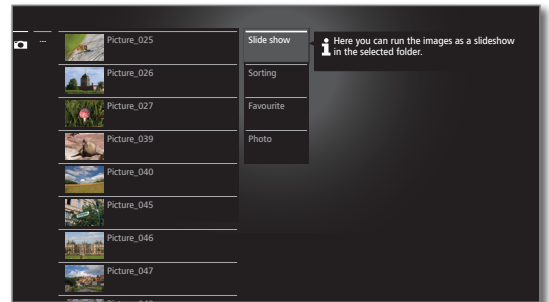

◀ ▶ Select station,
OK call.

Slide show Start slide show of the photos in the currently selected directory (see next page for further information).

Sorting Sort media files in the opened directory in alphabetical (ascending A-Z or descending Z-A) order, file size or date (newest entries first).

Favourite Add marked media file to the **Favourites** in Home view.

Photo Here you can do frequently used picture settings (Slide show speed, Crossover, Automatic rotate).

Select photo

- i** A photo source has been selected.
- i** The directory structure and the form of presentation of the photo selection is dependent on the selected source (example of a menu image: USB source).



◀ ▶ Select desired directory,
OK open directory.
 Repeat procedure if necessary.



◀ ▶ Select desired photo,
OK View photo zoomed to full screen.
 See next page for further information – **Photo display**.

Photo display

Description of the symbols in the status display for photos

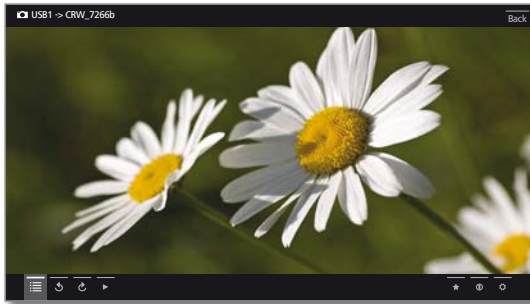

Full-screen mode

A photo is highlighted in the selection (**Folder view**).



OK View photo in full-screen mode.

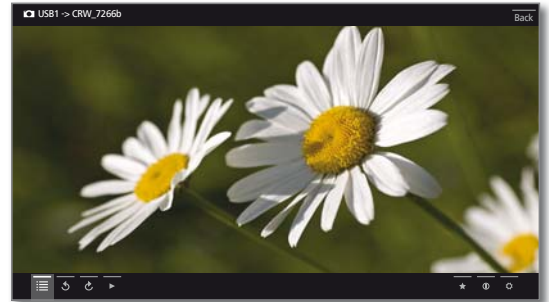

Show previous / next photo.

| Symbol (icon) | Remote control key | Description |
|---------------|--------------------|--|
| | - | Call Folder view (select photo). |
| | - | Rotate photo by 90 degrees to the left. (Rotate left) |
| | - | Rotate photo by 90 degrees to the right. (Rotate right) |
| | | Start slide show. |
| | | Pause slide show. |
| | short | Show previous photo. |
| | short | Show next photo. |
| | | Add currently displayed photo to the favourites in Home view. |
| | | Call detailed info on the displayed photo. |
| | | Call function list with photo settings. |

Rotating the photo



▲ ▼ Fade in photo status.

◀ ▶ Mark or .

OK Rotate photo by 90 degrees to the left/right.

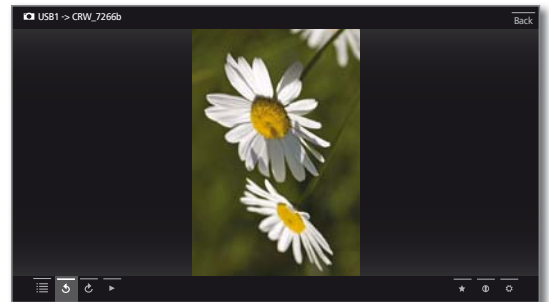

Slide show



PLAY key: Start slide show.

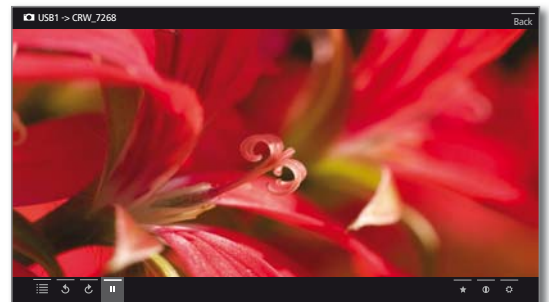

PAUSE key: Pause slide show.



PLAY key: Continue paused slide show.

Photo in full-screen mode / exit slide show



STOP key: Full-screen mode / end slide show and return to photo selection.

Explanation of keys

INFO (press longer): show Explanation of keys.

INFO or **BACK**: hide Explanation of keys.

Web

Here you have access to multimedia content in the Internet (MediaNet) as well as a high-quality web browser.

Calling the Web selection

HOME

HOME: Calling the **Home** view.



◀ ▶ ▾ ▴ Select **Web**.

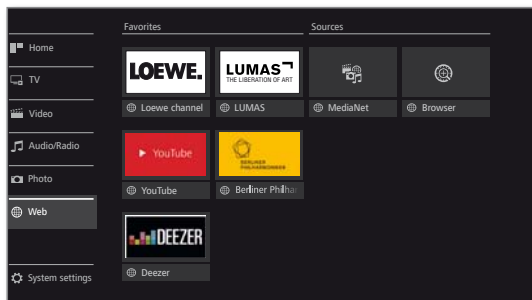

◀ ▶ ▾ ▴ Select favourite (if any) or source,
OK call.

Possible Web sources

MediaNet Under the menu item **MediaNet** you will find a continually expanding platform for interactive TV applications from the Internet (see next column). All applications are optimised for use on the TV.

Browser Call Web browser of the TV set. For further information see chapter **Web**, section **Browser**.

MediaNet

Call MediaNet

I To use the full functionality of MediaNet, the TV set must be connected to the Internet.

WEB

WEB: Call **MediaNet**¹.

or

HOME

HOME: Call **Home** view.



◀ ▶ ▾ ▴ Select **Web**.

◀ ▶ ▾ ▴ Select **MediaNet**,
OK call.

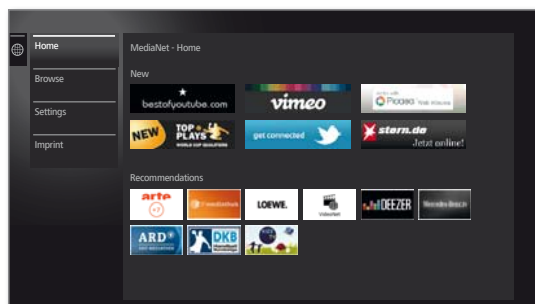

The upper portion of the MediaNet home screen contains new online content.

The lower portion of the MediaNet home screen contains **Recommendations** given by Loewe.

I The given content may change from time to time without prior notice.



▲ ▾ Select **Home**,

OK go to the right to choose the online content.

◀ ▶ ▾ ▴ Mark the desired online content,
OK Display/play content.

I The navigation within the various applications depends on the provider.

Functions in the MediaNet home screen

- Home** Displays the MediaNet home screen with a choice of new online content and recommendations.
- Browse** Under **Browse** you can list and call the online content by subjects.
- Settings** In the **Settings** for MediaNet you can select countries, for example, to take advantage of various services.
- Imprint** Providing the legally required information on the parties responsible for the content.

Exit MediaNet

HOME

HOME: Call **Home** view and select another function.

¹ The assignment of these keys can be changed (see chapter **System settings**, section **Control – Web key function**).

MediaNet – Browse

Under the item **Browse**, you browse the full range of applications by topic.

i MediaNet-Browse is called.

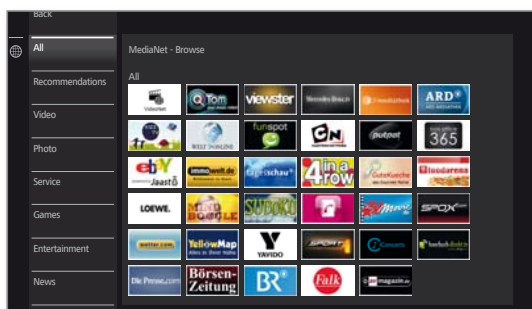

Filtering applications



▼ ▲ Select the genre / topic,
OK call applications of the genre.

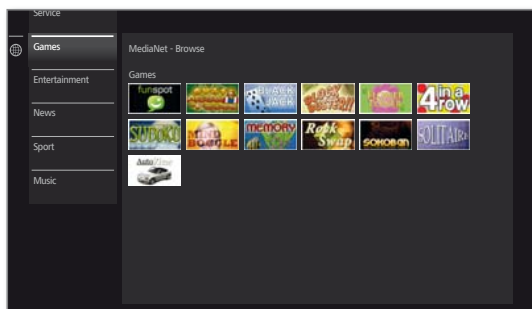

◀ ▶ ▼ ▲ Select desired application,
OK open application

Change filter



◀ Go to column with genres / topics.
▼ ▲ Select another genre / topic,
OK call applications of the selected genre.

Exit Browse



BACK: Return to the MediaNet home screen.

Or:



◀ Go to column with genres / topics.
▲ ▼ Select **Back**,
OK return to the MediaNet home screen.

Define application as favourite



◀ ▶ ▼ ▲ Mark the desired application.



Add the marked application to the **Home** favourites.
The favourite is added to view **Home** of web favourites and queued at the end.

MediaNet – Settings

Here, you can find setting options for MediaNet.

i MediaNet settings are called.

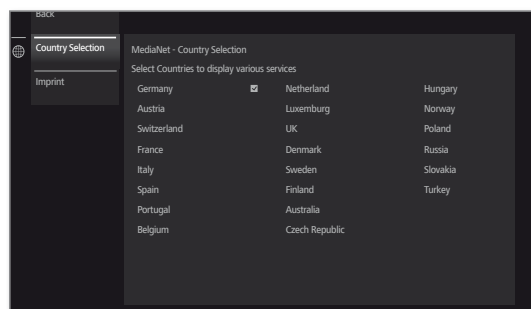

▼ ▲ Select the desired setting,
OK call.

Country Selection Select countries from which you want to get information on services (see below).

Imprint Providing the legally required information on the parties responsible for the content.

Country Selection



◀ ▶ ▼ ▲ Mark country,
OK select / deselect country.

Various services (applications, etc.) from countries that are marked with a tick are offered in **MediaNet**.

Exit Settings



BACK: Return to the MediaNet home screen.

Or:



◀ Go to column with settings.
▼ ▲ Select **Back**,
OK return to the MediaNet home screen.

Browser

You can access Internet sites directly using the integrated Opera browser. The web browser can also be used without an Internet connection. Thus you can access local devices which provide a web interface (e.g., router, home control, home network server).

Calling the Web browser



HOME: Calling the **Home** view.



◀ ▶ ▲ ▼ Select **Web**.

◀ ▶ ▲ ▼ Select **Browser**.

OK call.

Start page will be opened.

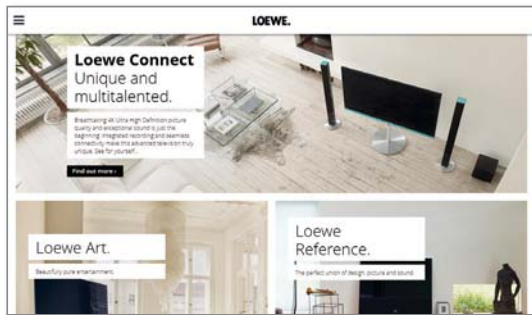

INFO: display browser status.

Explanation of the symbols in the browser status



Update the displayed Internet site. (**Reload site**)



Select as start page.

100% Change **zoom** factor of the displayed site / browser.



Add displayed Web site as favourite to **Home screen**.

Navigation on Web sites



P+ / P- Scroll page vertically.



◀ / ▶ Scroll page horizontally.



◀ ▶ ▲ ▼ Select link or text entry field with white mouse cursor faded in.

OK open link or confirm text input.



For the entry of text, press a numerical key (0-9) repeatedly as with a mobile phone until the desired character appears. The available letters are printed on the individual numerical keys.



Yellow key: Delete character.



BACK: Stop text entry and exit entry box.

Entering a URL (Internet address)

i Browser status is displayed.



◀ ▶ ▲ ▼ Mark the URL (Internet address) of the indicated Internet site.

OK Open address entry box.

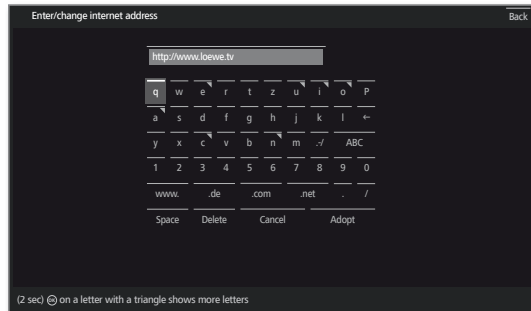

◀ ▶ ▲ ▼ Select required character.

OK Accept character.

In the event of letters with a triangular, additional letters are displayed when pressing the **OK** button longer (2 sec).

← Delete character to the left of the cursor.

.-/ The selection switches to special characters.

abc Switch between upper/lower case.

Space Enter blank space.

Delete Delete all characters.

Cancel Cancel input. The entry box will be closed and the previous Internet site will be displayed again.

Accept Accept address and open new Internet site.



i The characters may also be entered by the USB keyboard or the numerical keys of the remote control (see left column).

Exit Browser

i Web site is displayed. Browser status is hidden



HOME: Call **Home** view and select another function.



System settings

Under the menu item **System settings** in the **Home** menu you find all settings and adaptabilities of your TV set.

Calling System settings



HOME: Call **Home** view.



◀ ▶ ▾ ▹ Select **System settings**.
OK call.

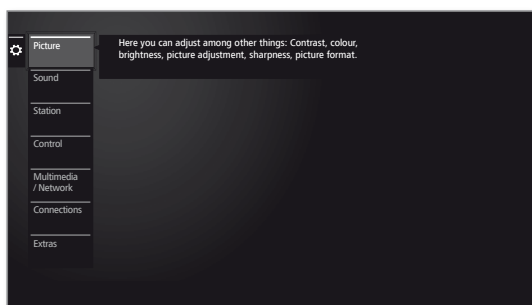

Or:



Press **MENU key** longer: call System settings.

Explanations of the setting options:

Picture Here you do the settings referring to the representation of the picture signal on your TV set.

Menu items **Picture:**

Picture adjustment, Contrast, Brightness, Color intensity, Image+ Active, Picture format.

Menu items **Picture → more ...:**

Colour temperature, Sharpness, Move picture up/down, Auto dimming, Auto format (AMD), Film quality improvement (DMM), Digital Noise Control (DNC), Skin tone, Gamma brightness correction, Deblocking filter.

For more information refer to chapter **System settings**, section **Picture**.

Sound Under this menu item you find the settings for sound playback.

Menu items **Sound:**

Sound adjustment, Loudness, Sound picture synchronisation, Volume adjustment.

Menu items **Sound → more ...:**

Auto volume, AV output signal, Maximum volume, Maximum switch on volume, Balance.

i The available menu items may vary and depend on the connected audio component.

For more information refer to chapter **System settings**, section **Sound**.

Stations Move and delete TV and radio stations. In addition to that you can automatically and manually update the complete station list. Your stations can also be arranged and optionally sorted in personal lists.

Menu items **Stations:**

Automatic scan TV+Radio, Manuell scan (incl. antenna status), Station lists TV, Station lists Radio, Update station list automatically, Transfer all station lists.

For more information refer to chapter **System settings**, section **Stations**.

Control In this menu you find settings for additional functions of your TV set like EPG, picture in picture (PIP), digital recorder (DR+) as well as interfunctional settings like time and date, parental lock or software update.

Menu items **Control:**

Language, Parental lock, EPG, Energy efficiency, Quick start mode, Software.

Menu items **Control → more ...:**

On-screen displays, Time and date, DVB settings, PIP, DR+, Standard Teletext, HbbTV, Hard disks, Export log file, WEB key function.

For more information refer to chapter **System settings**, section **Control**.

Multimedia / Network By means of the Multimedia / Network menu you configure your network adaptor and network access.

By means of the menu item **renderer** you can allow external devices to access your TV set (**renderer**) via app to **render** (play back) contents there.

Menu items **Multimedia / Network:**

Network settings, Multimedia settings, **Renderer**, TIDAL login.

For more information refer to chapter **System settings**, section **Multimedia / Network**.

Connections Use this menu to configure the TV set for operation with external devices.

The sound component wizard leads you comfortably through the configuration of your used audio equipment such as speaker systems or HiFi/AV amplifiers.

For more information, refer to the instruction manuals of the equipment used.

Menu items **Connections:**

Sound components, Antenna DVB, AV connecting settings, Digital Link, Gaming mode.

For more information refer to chapter **System settings**, section **Connections**.

Extras Under this menu item you can display the features of your TV set, repeat the initial startup or reset the device to the factory settings.

Menu items **Extras:**

Integrated features, Repeat initial installation, Reset to factory settings.

For more information refer to chapter **System settings**, section **Extras**.

Picture

Here you do the settings referring to the representation of the picture signal on your TV set.

Calling picture settings

HOME

HOME: Call **Home** view.



◀ ▶ ▲ ▼ Mark **System settings**,
OK call System settings.

▼ ▲ Mark **Picture**,
 ▶ go to next column.

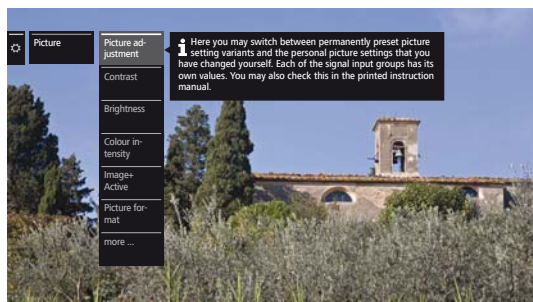

▲ ▼ Select desired picture function,
 ▶ proceed to next column.

Explanations of the picture settings:

Picture adjustment You can switch between several fixed picture adjustment modes and the personal picture values that you have set here.

See chapter **System settings**, section **Picture – Picture adjustment** for further information.

Contrast The contrast setting depends on the brightness of the room. The brighter the surroundings the higher the contrast should be set.
 The power consumption of the TV set depends directly on the value set here.

Brightness Set the brightness so that the black areas of the picture only just appear black.

Colour intensity Set the colour intensity to suit your personal taste. The colours should appear natural.
 You can pinpoint this by the colour of peoples' faces for example.

Image+ Active Image+ Active is a special picture improvement developed by LOEWE which provides a detailed and contrasting, sharper, natural and true colored picture which is rich in detail and contrast.

Picture format Select the format so that the screen is used to the fullest possible extent without affecting the natural proportions.
 See chapter **System settings**, section **Picture – Selecting the picture format** for further information.

more ... call with **OK** (see right-hand column).

Explanations of the picture settings (continuation):

Colour temperature Here, you can give the TV picture a warmer or colder hue according to your personal taste.

Sharpness Here you can adjust picture sharpness to obtain the best definition.

Move picture up/down In various picture formats, font or graphic insertions are not or only partially visible at the bottom or at the top.
 You can move the picture up or down with the up/down menu control keys to make the displays visible.
i Menu item only available in the picture formats panorama or zoom.

Auto dimming Depending on video (VBD+):
 The background lighting is reduced depending on the current video content and the video signal is simultaneously amplified in order to get an improved contrast of your TV picture (**V**ideo compensated **B**acklight **D**imming – VBD).

Auto format (AMD) When auto format is switched on, the TV set recognizes the picture format for Cinemascope or widescreen films and adjusts itself accordingly.

Film quality improvement (DMM) DMM reduces jolt in rapid picture object movements and rolling text displays. This applies especially for movies.

Digital Noise Control (DNC) With active DNC (Digital Noise Control) you can eliminate or reduce picture noise.

Skin tone Adjust the skin tone so that the most natural facial skin colour is achieved.

Gamma brightness correction If image seems over- or underexposed, you can adjust it here accordingly.

Deblocking filter To minimise the visible interference to the picture caused by modern compression methods for images and image sequences (formation of small blocks), a so-called deblocking filter can be activated which counteracts this interference.

PC IN display For some PC image formats, horizontal as well as vertical position and the phase position of the image can be corrected.

For more information, see chapter **System settings**, section **Picture – Selecting the picture format**.

i Menu item only available if there is a valid PC signal via the VGA adapter at the **AV** connection.



Picture adjustment

By selecting one of the preset picture adjustment modes (**Home Mode**, **Premium Mode**, **Cinema Mode** or **Shop Mode**), the picture settings for the respective currently active signal input group are set to predefined values.

You can use **Personal Mode** to specify individual settings for contrast, colour intensity, colour temperature, sharpness and digital noise suppression. Here you can enter your own specifications for each signal input group.

You find a listing of the various signal input groups in chapter **Technical Data**, section **Signal input groups**.

Calling picture adjustment



HOME: Call **Home** view.



◀ ▶ ▲ ▼ Mark **System settings**,
OK call System settings.

▼ ▲ Mark **Picture**,
 ▶ go to next column.

◀ ▶ Mark **Picture adjustment**,
 ▶ go to next column.



▼ ▲ Select mode,
OK adopt selected mode.

i When selecting one of the three preset picture adjustment modes you have to specify additionally if the mode shall be set only for the currently selected signal source, e.g., **Only for HD Digital** or **for the entire TV**.

Explanations of the picture adjustment modes:

| | |
|---------------|---|
| Home Mode | The emphasis for the picture settings is here on low energy consumption for home use. In this case, the TV set switches automatically off after 4 hours of unattended time. |
| Premium Mode | The picture settings in Premium Mode are optimised for a brighter environment at the cost of higher energy consumption. |
| Cinema Mode | The cinema mode is optimised for video and photo playback. |
| Shop Mode | The picture settings in Shop Mode are adjusted to operation in the presentation room. |
| Personal Mode | Here, you can recall your last personal picture settings. |

Selecting the picture format

i The setting options depend on the transmitted picture content.



HOME: Call **Home** view.



◀ ▶ ▲ ▼ Mark **System settings**,
OK call System settings.

▼ ▲ Mark **Picture**,
 ▶ go to next column.

◀ ▶ Mark **Picture format**,
 ▶ go to next column.

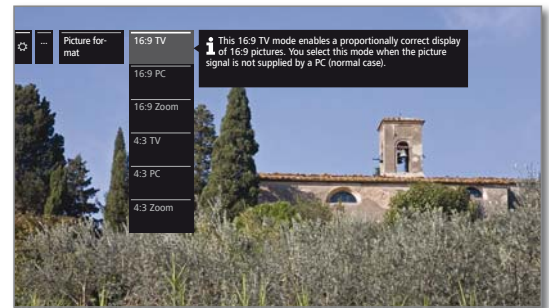

▼ ▲ Select format,
OK adopt selected format.

Explanations of the picture formats for HD signals:

| | |
|-----------|--|
| 4:3 TV | Proportionally correct display of 4:3 or 16:9 broadcasts. You select this mode when the signal is not supplied by a PC (normal case). A small part of the picture is truncated. This may be necessary to hide possible interference at the edge of the picture, which arises from the signal supplied. |
| 16:9 TV | |
| 4:3 PC | Proportionally correct display of 4:3 or 16:9 broadcasts without loss of information. You select this mode when the signal is supplied by a PC. |
| 16:9 PC | |
| 4:3 Zoom | Proportionally correct display. Maximum picture magnification. Displayed text may get lost. |
| 16:9 Zoom | |

Explanations of the picture formats for SD signals:

| | |
|------------|---|
| 16:9 | Proportionally correct display of 16:9 broadcasts. |
| 4:3 | Proportionally correct display of 4:3 broadcasts. |
| Panorama 1 | Proportionally correct display of 4:3 broadcasts on the 16:9 screen. Station logo and subtitles remain visible. |
| Panorama 2 | Format filling display (factory default) of 4:3 broadcasts on the 16:9 screen. Station logo and subtitles remain visible. |
| Zoom | Proportionally correct display. Maximum picture magnification. Displayed text may get lost. |
| PALplus | Is a 4:3-compatible 16:9 picture broadcast supplied by the station which is detected automatically. |

Sound

Calling the sound settings

The selectable menu items depend on the selected station and the connected sound components.

HOME

HOME: Call **Home** view.



◀ ▶ ▲ ▼ Mark **System settings**,
OK call System settings.

▼ ▲ Mark **Sound**,
 ▶ go to next column.



▲ ▼ Select sound function,
 ▶ proceed to next column.

Explanations of the sound settings:

Sound via Playback over the TV speakers or an external hi-fi amplifier.

i The menu item **Sound via** only appears if **HiFi/AV amplifier or TV speakers (switchable)** is set in the audio components wizard (see chapter **System settings**, section **Connections – Sound components**).

Sound adjustment Here, you can adapt preset sound characteristics of the respective broadcast. Selectable are, e.g., Speech, Classical, Pop, Custom music and Film soundtracks. For personal music and film sound you can do the settings for pitch and bass sound (high and low frequencies).

Loudness Proper boost of bass and treble tones at low volume.

Sound picture synchronisation If the sound and picture are not precisely in sync, you may correct this here. Move the mark on the bar downwards, slowing down the sound compared with the picture. Move the mark upwards, speeding it up compared with the picture. Time adjustment of the sound occurs in steps of 10 ms in each case.

i only available for DVB stations.

Volume adjustment The volume can differ according to the individual stations. If the sound is too loud or too quiet in relation to other stations, adjust the volume.

When the menu is open, you can select the stations one after another with **P+/P-** and adjust every single station conveniently.

more ... call with **OK**.

Explanations of the sound settings (continued):

Loudspeaker/Headphone sound For analogue stations: Selection options for Mono/ Stereo or Sound 1 or Sound 2 for bilingual programmes, separately for the loudspeakers and the headphones.

Auto volume The volume may vary when receiving stations with different standards, when switching from station to station or during commercials. You can reduce these differences in volume by selecting auto volume **on**. For music and live broadcasts you get a better sound spectrum with auto volume **off**.

Maximum volume You can limit the volume adjustment of the loudspeakers. This prevents selecting a volume which is too loud.

Maximum switch on volume Set the sound level to be heard after switching on the TV set with the mains switch or after a power failure. When switching on the TV set in standby mode, the volume last used is retained unless it was above this switch-on level. Otherwise it is limited by this.

Balance Set stereo balance so that the volume impression is identical on the left and right.



Stations

Under the item Stations you find all settings concerned with station search for TV and DVB radio as well as functions for creating and editing the various station lists.

- i** Station management is not possible as long as a programmed timer recording is active.
- i** If at least one station is locked, the access code must be entered prior to automatic search.
- i** The procedure for radio stations or Station lists Radio is similar to that for TV stations or Station lists TV. Therefore, this procedure is described only for TV stations.

Call Stations menu



HOME: Call **Home** view.



◀ ▶ ▲ ▼ Mark **System settings**.
OK call System settings.

▼ ▲ Mark **Stations**.
 ▶ go to next column.

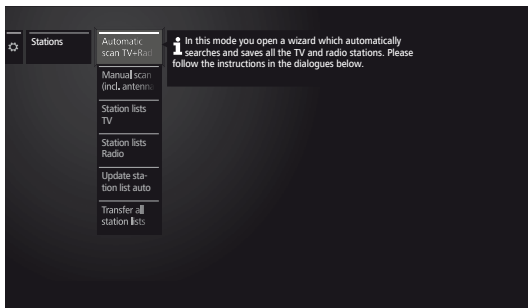

▲ ▼ Select desired function,
 ▶ proceed to next column.

Explanations of setting possibilities in the Stations menu:

- Automatic scan TV+Radio Here you start the wizard that searches and stores all TV and DVB radio stations (see chapter **System settings**, section **Stations – Automatic scan TV+Radio**).
- Manual scan (incl. antenna status) Here, you can enter all the settings available for a TV station (see chapter **System settings**, section **Stations – Manual Scan TV / Radio**).
- Station lists TV Here you can move and delete TV stations/ DVB radio stations in all lists.
- Station lists Radio You can put together your most frequently watched programmes in one or more lists of personal favourites (see chapter **System settings**, section **Stations – Station lists TV / Radio**).
- Update station list automatically If the channel list is not up to date, it will be updated automatically, provided the parameter **Allow** is selected (see chapter **System settings**, section **Stations – Update station list automatically**).
- Transfer all station lists Here you can export or import all station lists of this TV set (see chapter **System settings**, section **Stations – Transfer all station lists**).

Automatic scan TV+Radio

For automatic scan TV+Radio, a search wizard will be started that searches for new stations which are not yet stored.

I You have to repeat the initial installation and automatically search for new stations if you want to delete all the existing stations and automatically search for new ones.

HOME



HOME: Call **Home** view.

▼ ▲ Mark **System settings**.
OK call System settings.

▼ ▲ Mark **Stations**.
 ▶ go to next column.

▼ ▲ Mark **Automatic scan TV+Radio**.
 ▶ go to next column.

In the upper info text the current search settings will now be displayed:

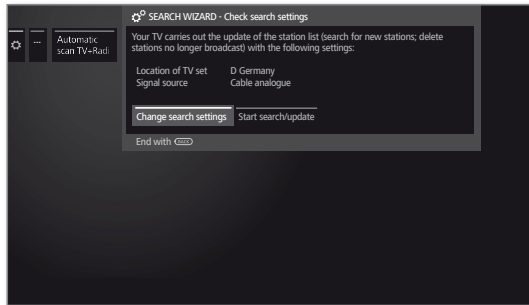

If you want to change these search settings:



◀ ▶ Select **Change search settings**.
OK wizard guides you through the search settings (see column on the right).

If you agree with these settings:

◀ ▶ Select **Start search/update**.
OK start scan.

BACK

BACK: Cancel current search/update.

Explanations of some search settings:

Signal source Select cable (analogue), DVB-T, DVB-C or DVB-S depending on which signal source you want to search for new stations.

Use the **Antenna wizard** to call the configuration of the DVB-T and DVB-S antennas.

I Calling up the DVB antenna configuration causes the Change search settings dialogue to be quit. You must call up the dialogue again after finishing the configuration.

Cable (analogue) TV/colour standard With the selection of TV set location the conventional TV standard/colour standard is the default. It should only be changed if stations with other standards are to be searched.

Explanations of some search settings (continued):

DVB-T/C/S Network selection If several networks are available, you can decide which network you want to receive your channels from.

DVB-T/C/S Settings With the selection of set location the conventional settings will be preset. Only change these defaults if you are familiar with other parameters.

Scrambled stations: (DVB-T/C/S)

You can state whether scrambled stations are to be searched for in the search/update. If you select **yes**, coded stations will also be searched for. However, these stations can only be received in connection with a CA module and the appropriate Smart Card. Ask your dealer which Smart Card you need to receive certain stations.

Search method: (DVB-T)

If you want to run the station search independently of the channel grid, select **Frequency search** for the search method.

Search method: (DVB-C)

If you select **Frequency search** here, a search is performed for all receivable stations. With **Network search**, only the stations which the networks supply are searched - either for all receivable networks or only for the particular network specified under **Network ID**.

Network ID: (DVB-C)

If you select **none** here, DVB signals of all current broadcasting networks are scanned automatically (recommended for most cable networks).

If, on the other hand, you specify a certain network ID (necessary in the cable networks of some countries), only DVB signals of this broadcasting network are searched for automatically. Your cable provider has the information you need.

Search method: (DVB-S)

If you select **Frequency search** here, a search is performed for all receivable stations. With **Network search**, from all receivable networks all the stations are searched which are supplied by these networks.

Accept Logical Channel Number: (DVB-T/C/S)



In various countries, digital stations (DVB-T/C/S) are transmitted with a preset channel number per station, known as Logical Channel Numbers (LCN).

If you select **yes** here, these default channel slots will be used and the channels of the preferred signal source will be sorted as per LCN. The stations in the station list can no longer be shifted.















Search for/update stations – handling of new and no longer found stations

The number of new TV stations found is displayed after the automatic search / update has been completed.













-  Proceed. The number of new radio stations found is displayed.
-  Call list of new TV stations found.



-      Select station.
OK Mark / unmark station.
-  Stores the marked TV stations.
 The list of new radio stations found is displayed.
-      Select station.
OK Mark / unmark station.
-  Proceed.

Afterwards, a list of the stations which are saved but which are temporarily not broadcasting or no longer exist is displayed, if available. The number of the memory location used is displayed in front of the station. Please select the stations you really want to delete.











-      Select station.
OK Mark / unmark station.
-  Proceed. The marked stations will be deleted. The list of radio stations no longer found is displayed.
-      Select station.
OK Mark / unmark station.
-  End search wizard.

Manual Scan TV / Radio

Here, you can enter all the settings available for a station. However, this requires detailed knowledge.

i The manual search of radio stations is similar to that of TV stations. Therefore, the manual search for radio station is not dealt with separately.

Calling manual search

-  **HOME:** Call Home view.
-    Mark **System settings**.
OK call System settings.
-   Mark **Stations**.
 go to next column.
-   Mark **Manual Scan (incl. antenna status)**.
OK call Manual Scan.

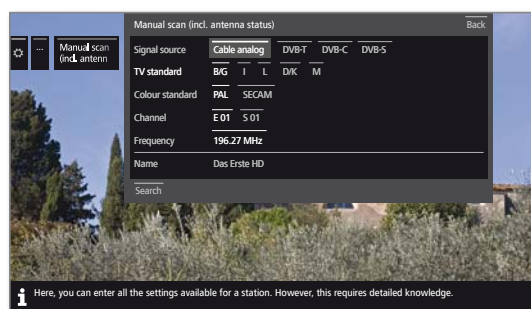

Select the menu item **Signal source** to decide in which area you want to search for stations. Depending on the selected source, various setting possibilities will be available. On the next page, the settings for analogue cable and DVB-T/C/S sources are described separately.

Status bar for manual search

Status bars are displayed for manual search, which show the reception quality of the individual stations during the station scan. The markers in all bars should preferably be in the green area.

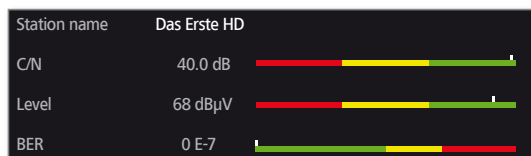

C/N: (Carrier/Noise) The bar shows the signal-to-noise ratio. The value indicated in dB should be preferably high.

Level: The bar shows the receiving level of the station. The value displayed in dBµV should be preferably high.

BER: (Bit Error Rate) The bar shows the bit error rate of the station. The value for BER should be as low as possible.

Manual search for cable analogue (analogue cable reception):

- Manual search is called.
- Cable analogue** has been selected as signal source.

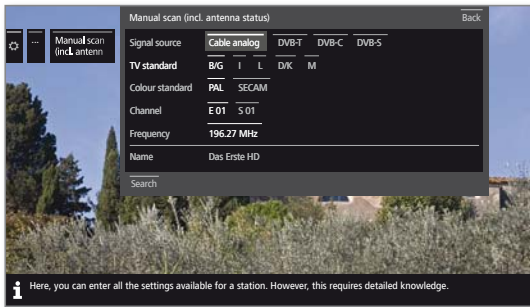

- ▲ ▼ ◀ ▶ Mark and adjust settings, **OK** confirm as the case may be.
- ▲ ▼ ◀ ▶ Mark Search, **OK** start search.

If a station has been found:

- ▲ ▼ ◀ ▶ Mark **Store/Overwrite**, **OK** store station.

Explanations on the search settings for cable analogue:

- Signal source** Selection of range in which you want to search for the station.
- TV standard** If necessary, ask your dealer which standard to select for specific channels or AV equipment.
- Colour standard** If necessary, ask your dealer which standard to select for specific channels or AV equipment.
- Channel** Direct input of channel.
- Frequency** Direct input of station frequency.
Range for entry: 044.75 MHz - 859.25 MHz.
- Name** Here, the name of the found station is displayed. You can change the name of the station.

Manual DVB-T/C/S search:

- Manual search is called.

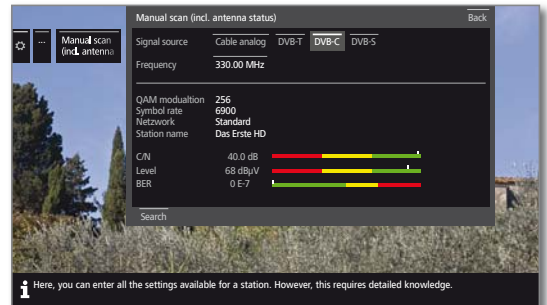

- ▲ ▼ ◀ ▶ Mark and adjust settings, **OK** confirm as the case may be.
- ▲ ▼ ◀ ▶ Mark Search, **OK** start search.

When a DVB transponder has been found:

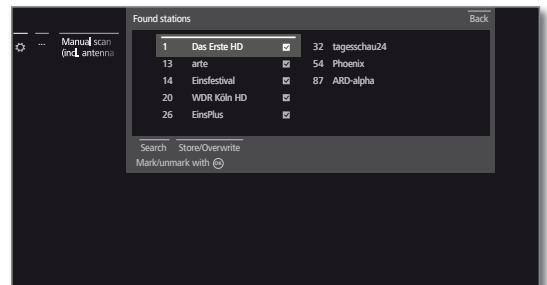

- ▲ ▼ ◀ ▶ Mark the station, **OK** Station will be ticked with . If necessary, repeat for several stations.
- Stations that already exist in the station overview will be displayed with their station number on the left.
- ▲ ▼ ◀ ▶ Mark **Store/Overwrite**, **OK** Stations marked with will be stored.

Explanations of some search settings:

- Signal source (DVB-T/C/S)** Selection of range in which you want to search for the station.
- Channel (DVB-T)** Direct input of channel.
- Satellite (DVB-S)** Here you can select the satellite where the stations are to be searched for.
- Band (DVB-S)** Here you can select the frequency band in which shall be searched.
Setting ranges:

| | |
|------------|-------------------|
| horiz/low | 10694 - 11906 MHz |
| horiz/high | 11544 - 12756 MHz |
| vert/low | 10694 - 11906 MHz |
| vert/high | 11544 - 12756 MHz |
- Frequency (DVB-T/C/S)** DVB-T/C: Direct input of station frequency.
DVB-S: Direct input of LNC frequency
- Symbol rate (DVB-S)** Here you can specify the symbol rate
Range: 1000-45000

Station lists TV / Radio

Under the menu item **Station lists TV** or **Station lists Radio** you can edit (delete block, move block, restore deleted stations, delete list) various lists, e.g., **DVB-T**, **ASTRA LCN**, **DVB-C**, etc. You can also create and edit new **Personal lists**.

i The function of Station lists Radio is similar to that of Station lists TV. Therefore, editing of Station lists Radio will not be dealt with separately.

Change station list

i If at least one station is locked, the access code must be entered before changing stations.

HOME

HOME: Call **Home** view.



▶ ▶ Mark **System settings**,
OK call system settings.

▶ ▶ Mark **Stations**,
 ▶ go to next column.

▶ ▶ Select **Station lists TV**,
 ▶ go to next column.

▶ ▶ Mark desired station list,
 ▶ call list.

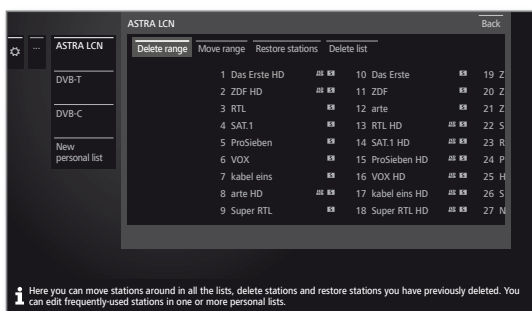

Here, you can delete and move station blocks as well as restore deleted stations.

The following section describes how to proceed if you wish to **Delete block**, **Move block**, **Restore stations** and **Delete list**.

Delete block



◀ ▶ ▶ ▶ Select **Delete Block**,
 ▼ move to list.

◀ ▶ ▶ ▶ Select beginning of block,
OK mark beginning of block.

◀ ▶ ▶ ▶ Select end of block,
OK mark end of block (selected stations are coloured blue).

◀ ▶ ▶ ▶ Select **Execute delete**,
OK block will be deleted, or

◀ ▶ ▶ ▶ select **Cancel procedure**,
OK cancel delete.

Move block / Change order

i Stations with LCN cannot be reordered. In this case, the function **Move block** is hidden.



◀ ▶ ▶ ▶ Select **Move block**,
 ▼ move to list.

◀ ▶ ▶ ▶ Select beginning of block,
OK mark beginning of block.

◀ ▶ ▶ ▶ Select end of block,
OK mark end of block (selected stations are coloured blue).

◀ ▶ ▶ ▶ Select insert position,
OK Confirm insert position.

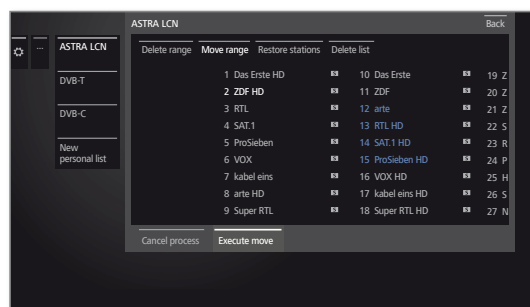

◀ ▶ ▶ ▶ Select **Execute move**,
OK block will be moved, or

◀ ▶ ▶ ▶ select **Cancel procedure**,
OK cancel move.

Restore stations



◀ ▶ ▶ ▶ Select **Restore stations**,
 ▼ move to list.

◀ ▶ ▶ ▶ Select beginning of block,
OK mark beginning of block.

◀ ▶ ▶ ▶ Select end of block,
OK mark end of block (selected stations are coloured blue).

◀ ▶ ▶ ▶ Select **Restore stations**,
OK stations will be added again to the station list, or

◀ ▶ ▶ ▶ select **Cancel procedure**,
OK cancel restore.

Delete list



◀ ▶ ▶ ▶ Select **Delete list**,
OK confirm delete list.

OK Confirm delete.

Compose / edit Personal list

Each personal list can contain up to 99 stations. You can compose the personal lists to suit your convenience (e.g., topic lists). Other persons using this TV set can create their own personal lists. You can create up to six personal lists.

i Creating and updating personal station lists is not possible as long as a programmed timer recording is active.

Create / edit New personal list

HOME

HOME: Call **Home** view.



▼ ▲ Mark **System settings**,
OK call System settings.

▼ ▲ Mark **Stations**,
 ▶ go to next column.

▼ ▲ Mark **Station lists TV**,
 ▶ go to next column.

▼ ▲ Mark **New personal list**,
OK New personal list x will be created.

i x stands for the number of the personal list.
 The number depends on how many list were already created.

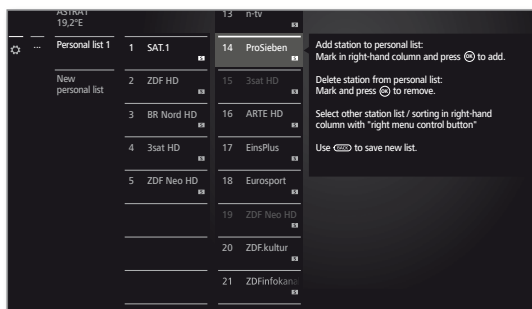

▲ ▼ Mark the station in the station list which is to be added to the personal list.

OK adds the station to the personal list.
 The new station will be added at the end of the personal list. Proceed in the same way with additional stations.

▶ Call up additional options.

ASTRA LCN DVB-T DVB-C Examples of station lists. Select the station list from which you add stations to the personal list. In the personal list you can store stations from different sources.

Sorting The sorting procedure for the source station list may be changed between numerical and alphabetical.

BACK

BACK: Store and close station list.

Adding stations to Personal list



i The Personal list must be opened to add new stations to it.

▼ ▲ Select **Add/remove Stations** in the function list.

How to add stations is described in the left column.

Deleting stations from the Personal list



i The Personal list must be opened to delete stations in it.

▼ ▲ Select **Add/remove Stations** in the function list,
OK activate.

◀ go to personal list.

▲ ▼ Mark the station to be deleted in the personal list,
OK activate. Function of the coloured keys in standard PIP functionality.

BACK

BACK: Store and close station list.

Move / reorder stations in the Personal list



i The personal list must be opened to move stations in it.

▼ ▲ Select **Move stations** in the function list,
OK activate.

▲ ▼ Select station to be moved in the Personal list,
OK mark (station will be coloured blue).

▲ ▼ Select insert position (insert position will be marked with a blue line).

OK Execute move. Proceed in the same way with additional stations.

BACK

BACK: Store and close station list.

Renaming the Personal list



i The Personal list to be renamed must be opened.

▼ ▲ Select **Rename list** in the function list,
OK activate.



Enter new name.



◀ ▶ ▲ ▼ Select **Adopt**.

OK New name for the personal list will be adopted.

Delete Personal list



i The Personal list to be deleted must be opened.
 Deleting of the list is irrevocable.

▼ ▲ Select **Delete list** in the function list,
OK activate.



Update station list automatically

Some programme providers offer an automatic update of the station lists (Dynamic Channel Management). You may **Allow** or **Block** an automatic station list update. If automatic updating is allowed, a screen message about an available update appears whenever the list is changed.

Allow/block updates

HOME

HOME: Call **Home** view.



▼ ▲ Mark **System settings**,
OK call System settings.

▼ ▲ Mark **Stations**,
 ▶ go to next column.

▼ ▲ Mark **Update station list automatically**,
 ▶ go to next column.

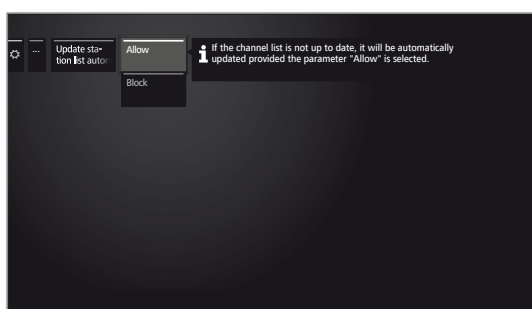

▼ ▲ Select **Allow** or **Block**,
OK adopt.

If the channel list is not up to date, it will be updated automatically, provided the option **Allow** is selected.

Updating the station list

A message appears whenever the TV is switched on if the network provider changes their channel list.

i In **Update station list automatically**, **Allow** must be selected.

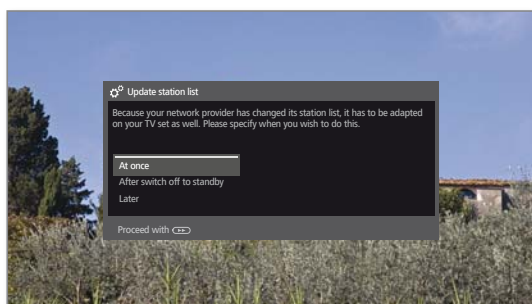

▲ ▼ Select the desired procedure.

At once The station list will be immediately updated. Normally this occurs in the background without interfering further with the TV's operation. In exceptional cases, it is however possible that during this process an automatic station change may be necessary.

After switch off to standby The channel list will be updated the next time the TV set is switched off into standby mode.

Later Updating the channel list will be postponed to a later date. When the TV set is switched on and off, the update message will appear again.



OK Confirm selection.

Transfer all station lists

You can export all station lists of your TV set to a USB storage device or import station lists.

Calling Transfer all station lists

HOME

HOME: Call **Home** view.



▼ ▲ Mark **System settings**,
OK call System settings.

▼ ▲ Mark **Stations**,
 ▶ go to next column.

▼ ▲ Mark **Transfer all station lists**,
OK call.

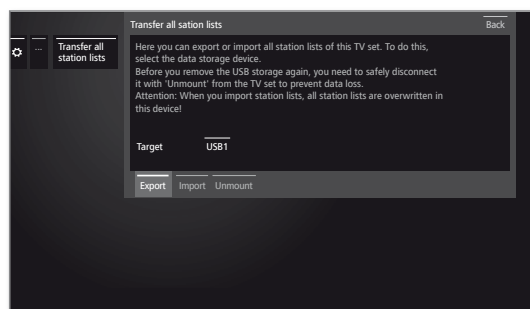

◀ ▶ ▲ ▼ Select a target if several USB storage media are available.

◀ ▶ ▲ ▼ Mark **Export** or **Import**,
OK confirm selection.

i When you import station lists, all station lists are overwritten in this device.

i Before you remove the USB storage again, you need to safely disconnect it with 'Unmount' from the TV set to prevent data loss.

Control

In the chapter Control you find settings for the various operating modes like PIP and DR+ as well as settings referring in an interfunctional way to your TV set like, for example, time and date and on-screen displays.

Calling Control



HOME: Call **Home** view.



◀ ▶ ▲ ▼ Mark **System settings**.
OK call System settings.

▼ ▲ Select **Control**.
 ▶ go to next column.

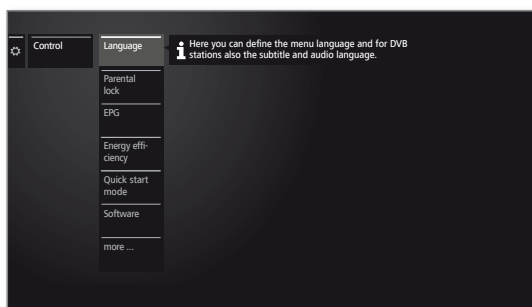

▼ ▲ Select desired menu item,
 ▶ go to next column.

Explanations of setting possibilities in the Control menu:

- Language** Here you can define the menu language and for DVB stations also the subtitle and audio language.
 See chapter **System settings**, section **Control – Language** for further information.
- Parental lock** With the parental lock you can bar access to all stations immediately or daily for a certain period of time. The stations can also be locked individually. Age-dependent locking of programs with an appropriate age code is also possible.
 See chapter **System settings**, section **Control – Parental lock** for further information.
- EPG** Here you can do all EPG settings.
 See chapter **System settings**, section **Control – EPG** for further information.
- Energy efficiency** Here you can determine how energy efficient your TV set shall be.
 See chapter **System settings**, section **Control – Energy efficiency** for further information.
- Quick start mode** Here you can enable the Quick Start Mode. The TV set will then immediately switch on from standby without delay.
 See chapter **System settings**, section **Control – Quick start mode** for further information.
- Software** Here you can download new software from a USB storage medium or from the Internet (as far as requirements exist for this).
 See chapter **System settings**, section **Control – Software** for further information.

more ... After confirmation with the **OK** key you will be offered additional not so frequently used sub items for the current menu item.

On-screen displays Here you can make settings for the duration, position and existence of special on-screen displays.
 See chapter **System settings**, section **Control – On-screen displays** for further information.

Time and date The time and date are normally obtained automatically from the TV.
 See chapter **System settings**, section **Control – Time and date** for further information.

DVB settings Here you can make settings which only refer to DVB stations (subtitles and audio mode, DVB character set).
 See chapter **System settings**, section **Control – DVB settings** for further information.

PIP In this menu you can make all adjustments for the picture-in-picture display.
 See chapter **System settings**, section **Control – PIP** for further information.

DR+ Here you can do all the settings for the digital recorder.
 See chapter **System settings**, section **Control – DR+** for further information.

Standard Teletext Here you can do all Standard Teletext settings.
 See chapter **System settings**, section **Control – Standard Teletext** for further information.

HbbTV Here you can do all settings for the HbbTV mode.
 See chapter **System settings**, section **Control – HbbTV** for further information.

Hard disks Here you find tools to format or check the hard disks.
 See chapter **System settings**, section **Control – Hard disks** for further information.

Export log file The log file available in the system is exported to a USB storage device.
 See chapter **System settings**, section **Control – Export log file**.

WEB key function Here you can assign another function to the **Web key**. The selected function will then be called directly when the key is pressed.
 See chapter **System settings**, section **Control – Web key function** for further information.



Language

Specify the language for all menus in the TV set in the language menu. The language for the DVB subtitles and the film language can be set for DVB programmes.

Call language

HOME

HOME: Call **Home** view.



◀ ▶ ▲ ▼ Mark **System settings**.
OK call System settings.

▼ ▲ Mark **Control**,
 ▶ go to next column.

▼ ▲ Mark **Language**,
 ▶ go to next column.

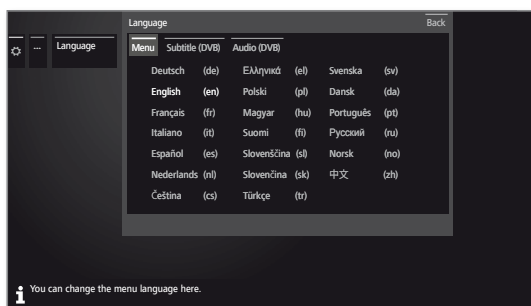

◀ ▶ ▲ ▼ Select desired setting and make changes.
OK Adopt settings.

Explanations of setting possibilities in the Language menu:

Menu You can change the menu language here.

Subtitle (DVB) If subtitles are provided by the DVB station, you can set your desired language in advance here. If this is included in the range of languages of the station, it will be shown automatically.

You can also specify an alternative language under this menu item, in case your chosen language is not offered by the station.

Audio (DVB) Specify your desired film language in advance here. If this is included in the range of languages of the station, it will be shown automatically.

You can also specify an alternative language under this menu item, in case your chosen language is not offered by the station.

EPG

Calling EPG settings

HOME

HOME: Call **Home** view.



◀ ▶ ▲ ▼ Mark **System settings**.
OK call System settings.

▼ ▲ Mark **Control**,
 ▶ go to next column.

▼ ▲ Mark **EPG**,
 ▶ go to next column.



Explanation of the EPG setting options:

Station selection TV In the **Station selection** you can determine for which station in the programme guide, information is to be displayed. Programme information is only displayed for stations with in the EPG list. Using the on-screen buttons in the bottom line you can mark all stations or unmark the stations or select stations from specific (e.g., personal) lists.

Further information on EPG station selection you find in chapter **TV**, section **Electronic Programme Guide – EPG wizard**.

Due to the large number of receivable stations you should restrict the station selection. This reduces the data entry time and increases the clarity in the EPG.

Data capture Here you can switch the data entry for the electronic programme guide (EPG) on and off.

If the data capture is switched on, your TV set tries to update the database overnight (normally between 2 and 5 am) or, if required, two minutes after switching to stand-by mode. The TV set must be on stand-by for this and not switched off at the mains switch.

The indicator on the TV set lights blue during data capture in stand-by mode.

The data are also updated while you are watching the EPG station.

TV on when memorised When **yes** is selected in the setting, the switched off TV switches on automatically in standby mode at the beginning of a memorised programme. A screen message appears when switching on. If this is not confirmed within 5 minutes with the **OK key**, the TV switches automatically off again for safety reasons.

Clear data base This menu item allows you to remove all data from EPG database. It will take some time to retrieve this data again.

Parental lock

You can select and set various security options to prevent unauthorised use of the TV set and to protect your children from unsuitable programmes.

Call Parental lock menu

HOME

HOME: Call Home view.



◀ ▶ ▲ ▼ Mark **System settings**,
OK call System settings.

▼ ▲ Mark **Control**,
 ▶ go to next column.

▼ ▲ Mark **Parental lock**,
 ▶ go to next column.

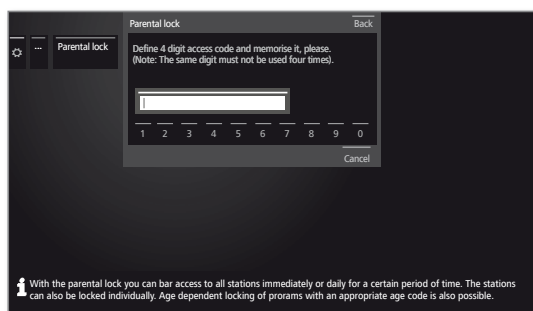

Define a four digit access code (PIN) the first time you open it. Note the access code (PIN) well.

i The access code must not consist of the same four digits.



◀ ▶ ▲ ▼ Mark **Adopt**,
OK activate.

The new PIN must be entered and confirmed again.

The **Parental lock** menu will be opened.

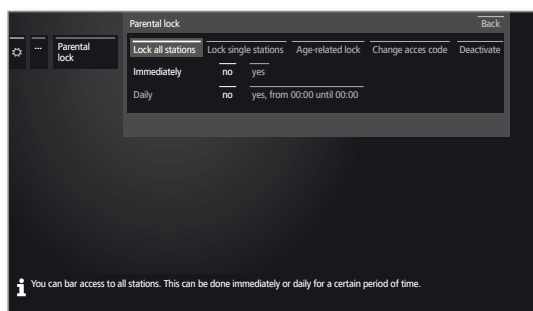

The four-digit access code (PIN) must be entered when the parental lock is opened in future. For security reasons, it appears encrypted (********) when entering.

Explanations of setting possibilities in the Parental lock menu:

- Lock all stations** The TV set is locked immediately the menu is exited. All programmes can then only be watched after entering the access code. The lock can be activated both **Immediately** and for a **Daily** defined period. The lock remains active until it is switched off in the menu.
- Lock single stations** You can lock / unlock individual or all of the stations in the station list specifically. The lock remains active until it is switched off in the menu.
- Age-related lock** Some DVB stations also broadcast an age classification. If the age set here is below the broadcast age limit, the programme can only be watched after entering the access code.
- Change access code** You can change your access code at any time. Enter the new access code in place of the old one.
- Deactivate** All set parental locks (locked stations, age-dependent locks, locked films in the DR+ archive) are cancelled. The current secret code is deleted. When the parental lock is reactivated all the previous parental locks are set again automatically.
- Reset** All currently set parental locks are finally cancelled. The access code is deleted.

Protection of minors for CI Plus programmes

Youth-protected broadcasts of programme providers with CI Plus encoding possibly require you to enter the secret number (PIN) of the CA module.

i The Parental lock PIN of the CA module can be store in the TV set. We recommend selecting the secret number of the TV set according to the secret number of the CA module, since the secret number of the CA module cannot be changed. This means that you must only remember one secret number.

Code number

The code number cancels all entered access codes. It can be used for example if you have forgotten your PIN. In the supplied user guide you find a note on the access code number. Remove this one from the user guide and keep it in a safe place.

Note for unlocking

As soon as the PIN has once been entered to unlock your TV set, all currently set parental locks will be disabled temporarily. Besides of the general locks described in this chapter, this is also valid for parental lock of DR+ archive entries. Parental locks will only be re-enabled when the TV set is switched off.

Energy efficiency

Determine how energy efficient your TV set shall be. The value for the contrast (and thus the brightness of the background lighting) is adapted and the automatic dimmer activated or deactivated depending on the presetting.

Call Energy efficiency

HOME

HOME: Call **Home** view.



◀ ▶ ▲ ▼ Mark **System settings**.
OK call System settings.

▼ ▲ Mark **Control**,
 ▶ go to next column.

▼ ▲ Mark **Energy efficiency**,
 ▶ go to next column.

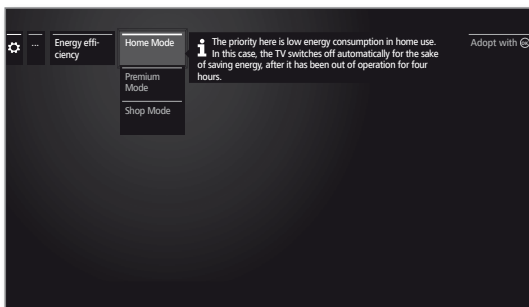

◀ ▶ ▲ ▼ Select desired setting and make changes.
OK Adopt settings.

Explanations of the setting options in the energy efficiency menu:

Home Mode The emphasis for home use is on low energy consumption. The automatic dimmer is activated.

i Choosing **Home Mode** automatically activates shutdown.

Premium Mode This mode optimises the settings to a brighter environment at a higher energy consumption. The automatic dimmer is activated.

The use of this energy efficiency setting must be confirmed afterwards once again.

Shop Mode The picture settings are aligned to operation in the presentation room. The automatic dimmer is deactivated. If the ambient brightness diminishes, the energy consumption is not reduced.

The use of this energy efficiency setting must be confirmed afterwards once again.

Quick start mode

If you enable the Quick Start Mode and you switch on the TV set from standby, the TV picture can be immediately seen without delay. You can specify the times at which your device will be in the Quick Start Mode.

Please note that in this case you will have a higher energy consumption.

i Default setting for the Quick Start Mode: **no**

Call Quick start mode

HOME

HOME: Call **Home** view.



◀ ▶ ▲ ▼ Mark **System settings**.
OK call System settings.

▼ ▲ Mark **Control**,
 ▶ go to next column.

▼ ▲ Mark **Quick start mode**,
 ▶ go to next column.

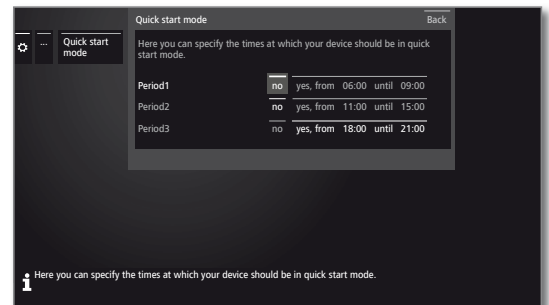

◀ ▶ ▲ ▼ Select desired setting and make changes.
 You can individually change the suggested times.

OK Adopt settings.

Software update

It is possible to update the software on your Loewe TV set.

In the software update (package update) all the software releases in the TV are scanned and updated as required.

Here you can download a new piece of software from different sources (if existing).

Current software versions can be downloaded from the Loewe Internet site (see below) and installed on your TV set using a USB stick.

If your TV set is connected to the Internet, the TV set can be updated directly via the Internet (see chapter **System settings**, section **Control – Manual update via the Internet**).

i Updating the software is not possible as long as a programmed timer recording is active.

i When a software update occurs it may happen that timer entries and memorised programmes are deleted. After such a software update, check your timer list (see chapter **TV**, section **Timer – Timer list**).

i Please be aware of the requirements of your USB stick in section **Technical data – Media**.

Software download from the Loewe Internet site for update via USB

Where available, you can download new software for your TV set from our homepage.

Visit our homepage under:

www.loewe.tv/int/my-loewe

Choose the item **Register now** on the Service homepage. Simply follow the steps in the registration process.

After the successful registration process and subsequent login to the support homepage you have to register your TV set (have the article number and serial number ready – both of these are on a label stuck to the back of the set or can be looked up under **System settings** → **Extras** → **Integrated features**).

Then you will get a list of downloadable contents for your TV set including the software. Download the data and unpack all the files in this ZIP archive into the main directory of your USB stick.

Then carry out the software update as described below.

USB stick - requirements

USB sticks tested by Loewe and compatible in type and format can be ordered from the Loewe dealer using the article no. 90456.900.

If you would like to use your own USB stick, please follow these tips/conditions:

- Formatting in FAT32.
- Just one partition.
- Do not use encrypted USB sticks.
- Do not use USB sticks that simulate a CD ROM drive.
- There may be no hidden files on the device.
- For some types of device, the construction of the USB stick is significant. Maximum dimensions in mm: 70x20x10.
- If in doubt, the USB stick should be formatted as "FAT32" without "extended attributes".

i In order to avoid problems during the software update of the tv set the USB stick in use should meet the requirements.



Software update via USB storage device

To do this, plug the USB stick with the downloaded software into a free USB port of the TV set.

Calling Software update

HOME

HOME: Call **Home** view.



◀ ▶ ▲ ▼ Mark **System settings**.
OK call System settings.

▼ ▲ Mark **Control**.
 ▶ go to next column.

▼ ▲ Mark **Software**.
 ▶ go to next column.

▼ ▲ Mark **Software update**.
 ▶ go to next column.

▼ ▲ Mark **Via USB**.
 ▶ call Software update.
 The version of the software package that is currently installed will be displayed.

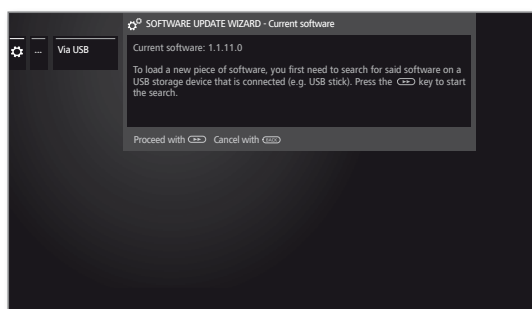

▶▶

▶▶ **Proceed.**

The TV set searches for a new software package on the USB stick.

If a new software version is available after the search, an on-screen message appears (see right hand column).

If several different software packages are found on the USB stick, the latest software package is always used.

If no new software package was found in the search:

BACK

BACK: End of wizard.

New software package found

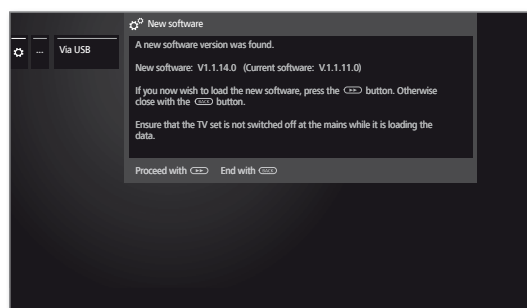

▶▶

▶▶ **Proceed** starts loading of the new software.

Or:

BACK

BACK: End of wizard.

The update will then **not** be carried out.

Load new software package

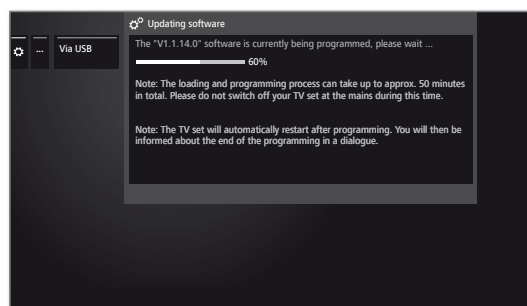

The software is loaded in several steps. The total loading and programming process can take up to approx. 50 minutes in total.

Please do **not** switch off your TV set with the mains switch during the entire loading and programming process.

After the update, the TV set is automatically powered off and on again.

i Depending on the software loaded, it is possible that the device may not turn off automatically after the update. Therefore, please supervise the update process.

When the TV set is switched on again, a message is displayed.

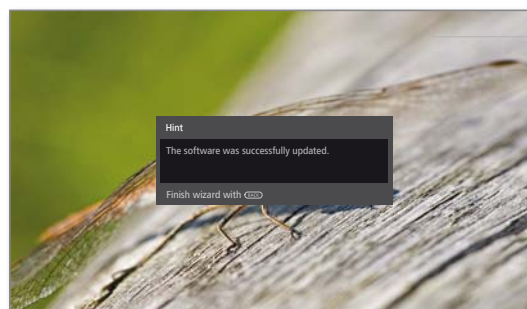

BACK

BACK: End of wizard.

Manual update via the Internet

If an Internet connection is available, new software can be downloaded directly and installed onto the TV set.

Calling Software update

HOME

HOME: Call **Home** view.



◀ ▶ ▲ ▼ Mark **System settings**.
OK call System settings.

▼ ▲ Mark **Control**.
 ▶ go to next column.

▼ ▲ Mark **Software**.
 ▶ go to next column.

▼ ▲ Mark **Software update**.
 ▶ go to next column.

▼ ▲ Mark **Via Internet**.
 ▶ go to next column.
 You will see a message on the screen regarding data protection.

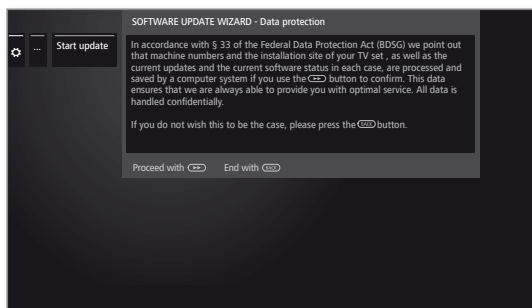

If you are not in agreement with the relevant data being passed on:

BACK

BACK: Exit the update process.
 The update will then **not** be carried out.



Otherwise: Confirm data protection message by pressing ▶▶.

The version of the software package that is currently installed will be displayed.

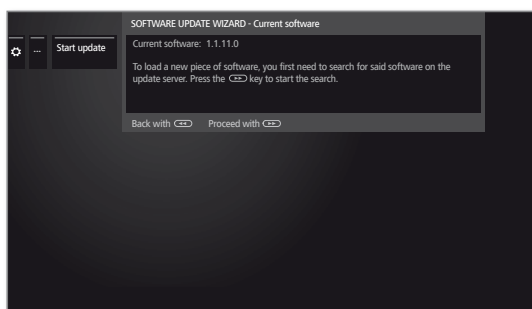

▶▶ **Proceed.**

The TV set connects to the Internet and scans the update server for new software.

If a new software version is available after the search, an on-screen message appears (see right hand column).

If no new software package was found in the search:

BACK

BACK: End of wizard.

New software package found

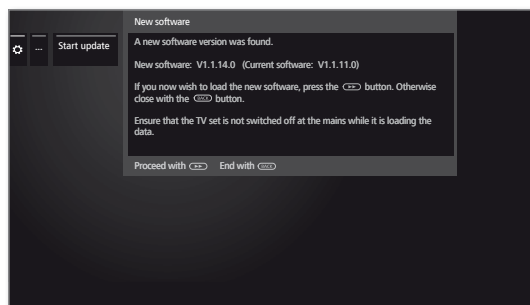

▶▶ **Proceed** starts loading of the new software.

Or:



BACK: End of wizard.
 The update will then **not** be carried out.

Load new software package

Only the parts of the software package that are not up to date will be automatically downloaded from the Internet and updated.

Each part of the software is downloaded individually from the Internet and is then programmed.

The total time required for all the software parts to be downloaded from the Internet is dependent on the speed of data transfer that is being used.

The total programming process can take up to 50 minutes in total.

Please do **not** switch off your TV set with the mains switch during the entire loading and programming process.

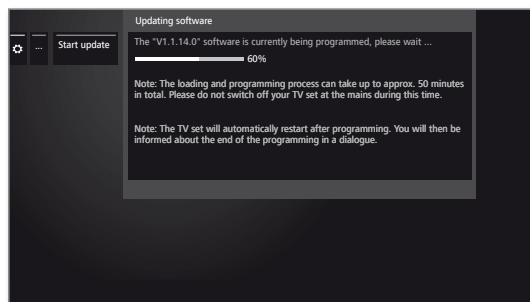

After the update, the TV set is automatically powered off and on again.

I Depending on the software loaded, it is possible that the device may not turn off automatically after the update. Therefore, please supervise the update process.

When the TV set is switched on again, a message is displayed.



BACK: End of wizard.

Software update via Antenna

i A software update via antenna is only available for stations of the Freeview DVB-T platform in the UK and Ireland.

Calling Software update

HOME

HOME: Call Home view.



◀ ▶ ▲ ▼ Mark **System settings**.
OK call System settings.

▼ ▲ Mark **Control**.
 ▶ go to next column.

▼ ▲ Mark **Software**.
 ▶ go to next column.

▼ ▲ Mark **Software update**.
 ▶ go to next column.

▼ ▲ Mark **Via Antenna**.
 ▶ call Software update.
 You will see a message on the screen regarding data protection.

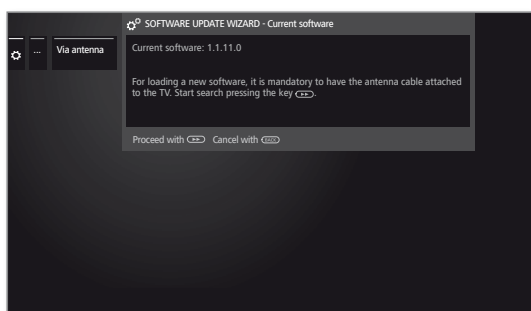

▶▶

▶▶ **Proceed.**

The TV set searches for a new software package.

If a new software version is available after the search, an on-screen message appears (see below).

If no new software package was found in the search:

BACK

BACK: End of wizard.

New software package found

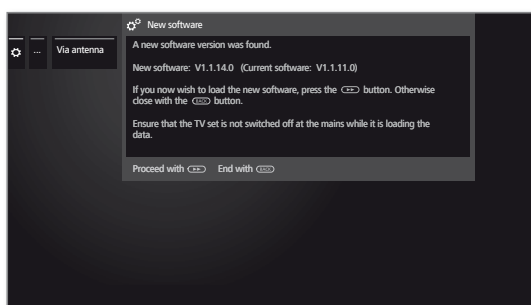

▶▶

▶▶ **Proceed** starts loading of the new software.

Or:

BACK

BACK: End of wizard.

The update will then **not** be carried out.

Load new software package

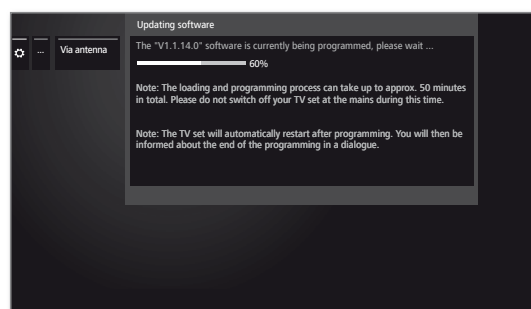

The software is downloaded in several steps. The total downloading and programming process can take up to approx. 50 minutes in total.

Please do **not** switch off your TV set with the mains switch during the entire loading and programming process.

After the update, the TV set is automatically powered off and on again.

i Depending on the software loaded, it is possible that the device may not turn off automatically after the update. Therefore, please supervise the update process.

When the TV set is switched on again, a message is displayed.

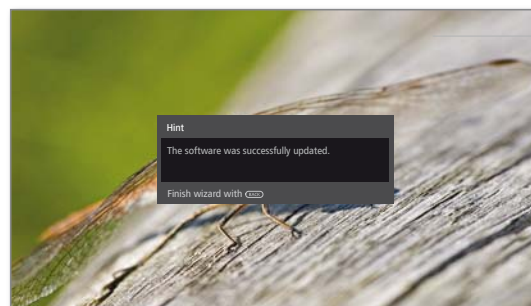

BACK

BACK: End of wizard.

Automatic update via the internet

Your TV set checks at definite intervals whether a newer software than the one installed in the TV set is available in the Internet. If this is the case, you can find this out by a screen message.

i In order to get informed about the new software, the TV set must be connected to the Internet.

i The **Inform about new software** item can also be switched on/off at the end of initial installation.

Showing/Hiding information on new software

HOME

HOME: Call **Home** view.



◀ ▶ ▲ ▼ Mark **System settings**,
OK call System settings.

▼ ▲ Mark **Control**,

▶ go to next column.

▼ ▲ Mark **Software**,

▶ go to next column.

▼ ▲ Mark **Software update**,

▶ go to next column.

▼ ▲ Mark **Via Internet**,

▶ go to next column.

▼ ▲ Mark **Inform about new software**,

▶ go to next column.



▼ ▲ Select **yes / no**,
OK Adopt.

New software package found

i For the menu item **Information on new software updates**, **yes** is selected (see left column).

If the TV set has found a new software version during the check, you will be informed about this via a screen message.



▲ ▼ Select the desired procedure.

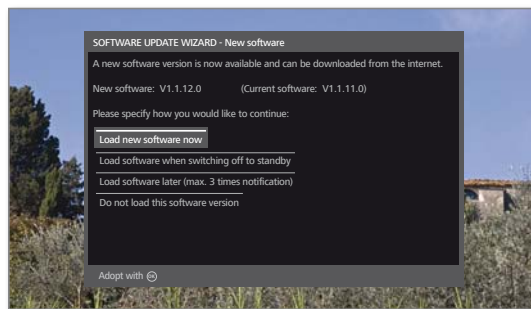

Load the software now After confirmation, the new TV software will be loaded from the internet and then programmed.

Load the software when switch off to standby The software will be loaded and programmed after the TV set has been switched off into standby mode for the next time. The display on the control panel will light up blue during the update. The TV set must **not** be switched off at the mains before the downloading process is complete (control panel display lights up white)!

Load the software later (at most three-fold notification) Loading the software will be postponed to a later date. The new software message will be displayed the next time the TV set is switched on. If the loading process is postponed three times then the message will only be shown again once the next software version is available.

Do not load this software version The new software will not be loaded. The on-screen message will only be shown again for the next software version.



Confirm selection.



On-screen displays

You can select different settings in this menu which affect the on-screen displays.

Call On-screen displays

HOME

HOME: Call Home view.



◀ ▶ ▲ ▼ Mark **System settings**.
OK call System settings.

▼ ▲ Mark **Control**.
 ▶ go to next column.

▼ ▲ Mark **more ...**.
 ▶ call other settings.

▼ ▲ Mark **On-screen displays**.
 ▶ go to next column.

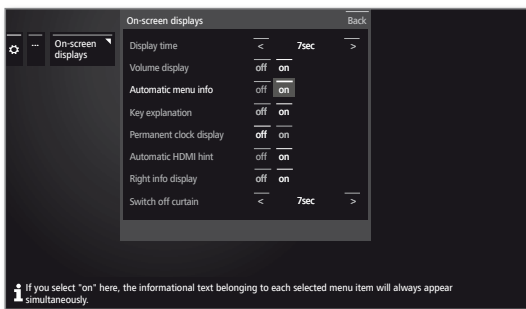

◀ ▶ ▲ ▼ Select desired setting and make changes.
OK Adopt settings.

Time and date

The time and date are normally acquired automatically by the TV set. If the data is missing or wrong, you can adjust it via the time and date menu.

Call Time and date

HOME

HOME: Call Home view.



◀ ▶ ▲ ▼ Mark **System settings**.
OK call System settings.

▼ ▲ Mark **Control**.
 ▶ go to next column.

▼ ▲ Mark **more ...**.
 ▶ call other settings.

▼ ▲ Mark **Time and date**.
 ▶ go to next column.

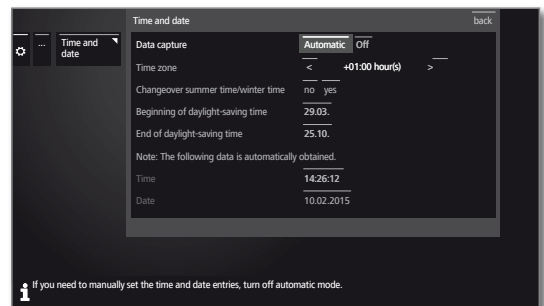

◀ ▶ ▲ ▼ Select desired setting and make changes.
OK Adopt settings.

Explanations of setting possibilities in the On-screen displays menu:

- | | |
|-------------------------|--|
| Display time | Here you set the duration of the display, e.g. for the volume or the station display when changing stations. The duration can be set between 2 and 9 seconds. |
| Volume display | Here you set whether a volume change is also to be indicated visibly on the screen. |
| Automatic menu info | Herewith you activate/deactivate the info text displays for the currently selected menu item. |
| Key explanation | If yes is set, the assignment of special remote control keys is indicated together with the TV status display. |
| Permanent clock display | The time display can be permanently shown. It is always visible as long as no other display is made. |
| Automatic HDMI hint | If yes is set here, a message about the adapted function of the remote control is shown whenever you switch over to an HDMI channel position to which a Digital Link HD capable TV set is connected. |
| Right info display | This activates/deactivates the right-hand additional on-screen display in the status bar when switching between channels. |
| Switch off curtain | Here you can specify whether there is a switch-off curtain (0 = no curtain) and how long this one needs for closing. |

Explanations of setting possibilities in the Time and date menu:

- | | |
|--------------------------------------|--|
| Data capture | If you need to set the time and date entries manually, turn off the automatic setting here. |
| Time zone | The current time at the Greenwich Meridian 0 is to be understood as world time. The time shift in relation to this time must be given in hours (-11 to +13). |
| Changeover summer time / winter time | If the summer time in your country is changed to Daylight-saving time, select yes please. |
| Beginning of daylight-saving time | Enter the date on which the time is switched over to summer time if it deviates from the automatically calculated date. This menu item appears only if yes was selected for Daylight-saving time. i Only possible when changeover summer time / winter time – yes has been selected. |
| End of daylight-saving time | Enter the date on which the summer time ends if it deviates from the automatically calculated date. This menu item appears only if yes was selected for Daylight-saving time. i Only possible when changeover summer time / winter time – yes has been selected. |
| Time Date | Enter the time (00:00 to 23:59) / date (day.month.year) with the numerical keys of the remote control. i Only possible when Data capture - off or when time has not been automatically acquired. |

DVB settings

You can make general pre-settings for DVB stations.

Calling DVB settings

HOME

HOME: Call **Home** view.



◀ ▶ ▲ ▼ Mark **System settings**,
OK call System settings.

▼ ▲ Mark **Control**,
 ▶ go to next column.

▼ ▲ Mark **more ...**,
 ▶ call other settings.

▼ ▲ Mark **DVB settings**,
 ▶ go to next column.

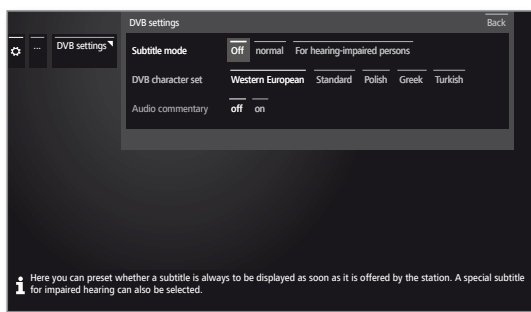

Explanation of the DVB setting options:

- | | |
|-------------------|--|
| Subtitle mode | Here you can preset whether a subtitle is always to be displayed as soon as it is offered by the station. A special subtitle for impaired hearing can also be selected. Subtitles are not offered by all stations. Many stations only broadcast subtitles by teletext. |
| DVB character set | Select the DVB character set so that the title of the broadcast of your favourite received station or the texts of your CA module are displayed correctly. |
| Audio commentary | You can preset the system here to always play a special soundtrack for the visually impaired whenever one is available. This soundtrack uses an audio commentary to describe the action taking place on-screen. |

PIP

Adjust size of the PIP image

HOME

HOME: Call **Home** view.



◀ ▶ ▲ ▼ Mark **System settings**,
OK call System settings.

▼ ▲ Mark **Control**,
 ▶ go to next column.

▼ ▲ Mark **more ...**,
 ▶ call other settings.

▼ ▲ Mark **PIP**,
 ▶ go to next column.

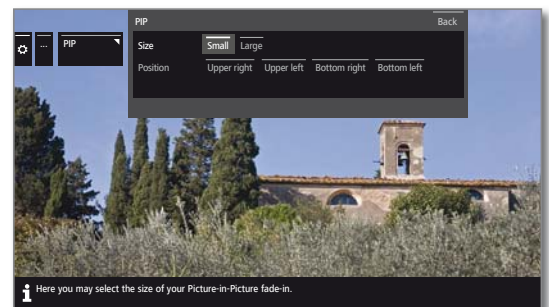

◀ ▶ ▲ ▼ Select desired setting and make changes.
OK Adopt settings.

Explanations of setting possibilities in the PIP Settings menu:

- | | |
|----------|---|
| Size | You can choose if your second picture faded in (picture in picture) shall be displayed small or large . |
| Position | Here you can set the position of the second inserted picture (picture in picture). You can position the second picture on the top right, top left, bottom right and bottom left . |



DR+

You can adapt the digital recorder to suit your needs when you record programmes on an externally attached USB hard disk.

Call settings for the digital recorder

HOME

HOME: Call Home view.



◀ ▶ ▲ ▼ Mark **System settings**.
OK call System settings.

▼ ▲ Mark **Control**.
 ▶ go to next column.

▼ ▲ Mark **more ...**.
 ▶ call other settings.

▼ ▲ Mark **DR+**.
 ▶ go to next column.

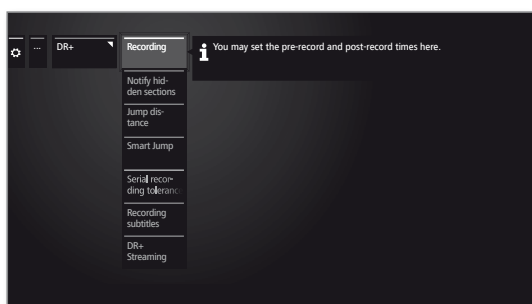

▼ ▲ Mark desired setting.
 ▶ go to next column.

▼ ▲ Make settings,
OK confirm setting.

Serial recording tolerance The serial recording tolerance is necessary to avoid recording a serial more than once when it is broadcast more than once a day.

It is only recorded when it begins within the given time interval (start time + series recording tolerance).

Use the numeric button on the remote control to enter the time (always two-digit for 01 to 60 min.).

Factory setting: **± 30 min.**

Recording subtitles Select here whether subtitles are to be recorded for DVB stations.

Factory setting: **no**¹.

DR+ Streaming Here, all settings are made in order to use the DR+ archives of other LOEWE TV sets in the home network.

See next page for further information.

Explanation of the DR+ setting options

Recording You can set a pre-record and post-record time for timer recordings made without auto time control. This minimizes the risk that a part of the broadcast is not recorded due to the broadcast starting earlier and/or finishing later.

Factory setting: pre-record time: **1 min**,
 post-record time: **5 min**.

Notify hidden sections If an entry has been hidden in an archive recording, you can get informed by a screen message when skipping a hidden area.

Factory setting: **yes**.

Jump distance Set the standard jump distance (in minutes) used for jumping forwards or backwards in the movie by briefly pressing the ◀◀ or ▶▶ keys.

Factory setting: **2 min**.

Smart jump If the „Smart jump“ mode is activated you can approach a desired place by pressing the ▶▶ and ◀◀ buttons alternately and halving the jump width. After every 3rd jump in the same direction the jump width is doubled (up to a maximum of 8 minutes).

If **off** is set you always jump the same currently set jump width (time) with the ▶▶ and ◀◀ buttons.

Factory setting: **on**

¹ for devices in DK, FIN, N or S: **yes**.

Call DR+ streaming settings

The **DR+** settings are called (see previous page).



- ▼ ▲ Mark **DR+ Streaming**,
 ▶ go to next column.

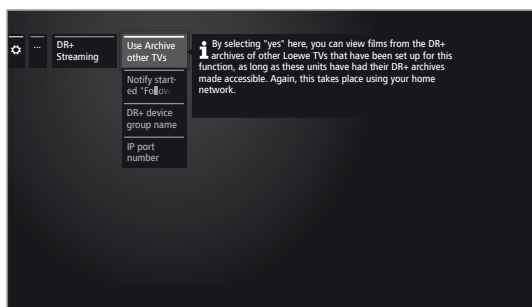

- ▼ ▲ Mark desired setting,
 ▶ go to next column.
- ▼ ▲ Make settings,
OK confirm setting.

Explanation of the setting options for DR+ streaming

Also use other archives. Setting **yes** enables you, via the archive, to also view recordings from other TV sets that have accessible archives (client function).

Notify started „Follow me“ recording. Please indicate here whether your TV should provide automatic notification when a programme is available for viewing as soon as this has been started as a „Follow me“ recording on another TV in the network.

DR+ device group name. Give a name for your TV set group. Using different group names enables you to group your TV sets as required. Only TV sets under the same group name can exchange data.

IP port number. IP port numbers are preset ex-factory. Under normal circumstances they do not require amending.

Standard Teletext

In the **Standard Teletext** menu you can configure the Teletext.

Call Teletext settings



HOME: Call Home view.



- ◀ ▶ ▲ ▼ Mark **System settings**,
OK call System settings.

- ▼ ▲ Mark **Control**,
 ▶ go to next column.

- ▼ ▲ Mark **more ...**,
 ▶ call other settings.

- ▼ ▲ Mark **Standard Teletext**,
 ▶ go to next column.

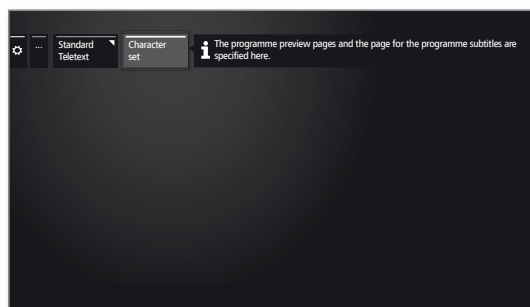

Explanations of the Standard Teletext menu functions:

Character set. Teletext character set can be switched to other languages (Russian, Greek, Polish and Turkish).



HbbTV

Here you can do all settings for the HbbTV mode.

Call HbbTV settings

HOME

HOME: Call **Home** view.



◀ ▶ ▲ ▼ Mark **System settings**.
OK call System settings.

▼ ▲ Mark **Control**,
 ▶ go to next column.

▼ ▲ Mark **more ...**,
 ▶ call other settings.

▼ ▲ Mark **HbbTV**,
 ▶ go to next column.

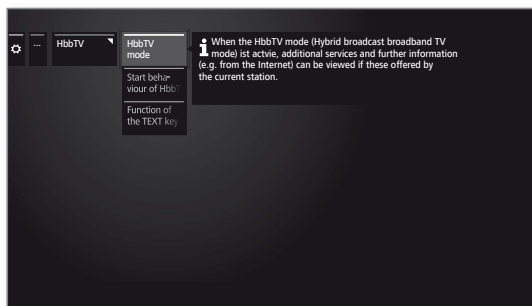

▼ ▲ Mark desired setting,
 ▶ go to next column.

▼ ▲ Make settings,
OK confirm setting.

Explanation of the setting options for HbbTV

HbbTV-Modus When the HbbTV mode is active (factory setting), additional services and further information (e.g., also from the Internet) can be viewed if these are offered by the current station.

Start behaviour of HbbTV-stations If **HbbTV mode – on** has been selected, you can specify if an available HbbTV application should be loaded **automatically** after the channel has been changed or if this should only occur **manually** after the red key has been pressed once. The startup behaviour can be set for TV and radio stations.

i After loading the HbbTV application, an on screen message is displayed (depending on the channel that is being viewed).

Function of the TEXT key With the setting **Standard Teletext first** (factory setting), the standard Teletext is opened when the **TEXT key** is pressed for the first time. Pressing the **TEXT key** for a second time will then display the MediaText. Pressing the **TEXT key** for a third time will bring you back to the TV picture. If **MediaText first** is selected, the **TEXT key** will do the exact opposite.

i Depending on the programme provider, the direct Call of MediaText may not be possible. MediaText must then be opened by means of the HbbTV application.

Hard disks

Formatting the external hard disk

If problems occur when operating the external hard disk, these may be fixed by formatting the hard disk. Additionally, you can re-format the hard disk in order to quickly and easily delete all the data stored on it.

Warning!

Formatting the hard disk will erase all data stored on it!

HOME

HOME: Call **Home** view.



◀ ▶ ▲ ▼ Mark **System settings**.
OK call System settings.

▼ ▲ Mark **Control**,
 ▶ go to next column.

▼ ▲ Mark **more ...**,
 ▶ call other settings.

▼ ▲ Mark **Hard disks**,
 ▶ go to next column.

▼ ▲ Mark **Format external one**,
 ▶ confirm.

A warning note will be displayed.



OK Press at least for three seconds to start formatting.

BACK

Or:
BACK: Cancel procedure

i Never ever switch off the TV set during a formatting process.

After the formatting, a message will appear on the screen showing the results of the formatting and tips on how to resolve any problems that exist, should there be any.

i After the formatting the TV set must be switched off and on again.

Note on formatting external USB disks:

The TV set supports the two hard disk file systems FAT 32 and NTFS. External hard disks are formatted by the TV in the FAT32 file system to full capacity.

i With FAT32, the maximum size of a file is 4 GB.

i For a parallel use of TV and PC, we recommend that you reformat the hard disk on a PC to NTFS.

Export log file

To resolve problems, a log file can be provided for the service. The log file can be exported to a USB storage device or manually or automatically transferred via the Internet.

i The log file can be transferred via the Internet only when an online connection exists. The transferred data is anonymous and purely of technical nature without reference to person, location or IP address. Browser history or login details are **not** stored or transferred.

Call export of the log file

HOME

HOME: Call **Home** view.



◀ ▶ ▲ ▼ Mark **System settings**,
OK call System settings.

▼ ▲ Mark **Control**,
 ▶ go to next column.

▼ ▲ Mark **more ...**,
 ▶ call other settings.

▼ ▲ Mark **Export log file**,
 ▶ go to next column.

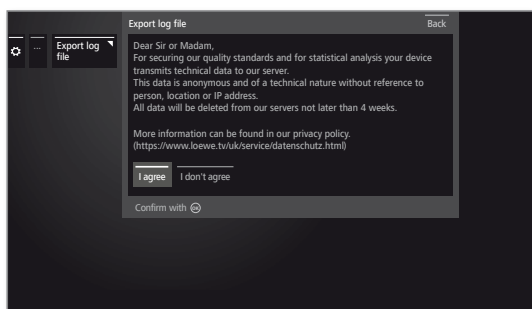

◀ ▶ ▲ ▼ Select **I agree**, if you accept the privacy policies,

OK Confirm selection.

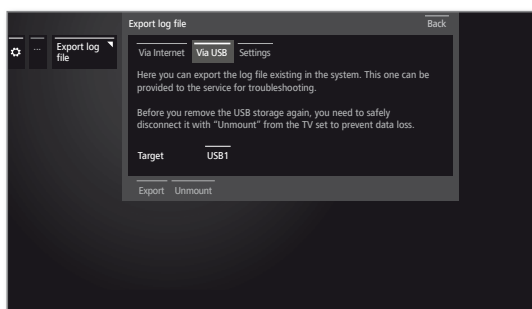

◀ ▶ ▲ ▼ Select **Via Internet**, **Via USB** or **Settings**.

When selecting **Via Internet**:

◀ ▶ ▲ ▼ Mark **Export log files now**,
OK confirm selection.

This transfers all stored log files to the Loewe server.

After successful transmission, a reference number will be displayed that you can specify as a reference when making inquiries.

When selecting **Via USB**:

◀ ▶ ▲ ▼ Select a target if several USB storage media are available.

◀ ▶ ▲ ▼ Mark **Export**,
OK confirm selection.

i Before you remove the USB storage again, you need to safely disconnect it with **Unmount** from the TV set to prevent data loss.

When selecting **Settings**:

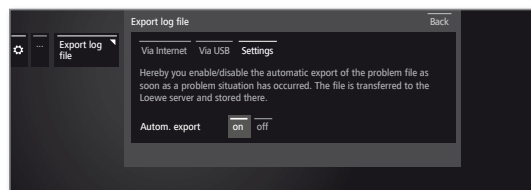

◀ ▶ ▲ ▼ Mark the desired setting.

Autom. Export Herewith you enable/disable the automatic export of the problem file as soon as a problem situation has occurred.

When set to **on**, the file is automatically transferred to the Loewe server and stored as soon as a problem situation has occurred.

WEB key function

You can assign the Web key on the remote control unit a particular function (MediaNet, picture/sound menu, Picture format, etc.). The selected function will then be called directly when the key is pressed.

Call WEB key settings

i Default setting: **MediaNet**

HOME

HOME: Call **Home** view.



◀ ▶ ▲ ▼ Select **System settings**,
OK call System settings.

▼ ▲ Select **Control**,
 ▶ go to next column.

▼ ▲ Select **more ...**,
 ▶ call other settings.

▼ ▲ Select **WEB key function**,
 ▶ go to next column.

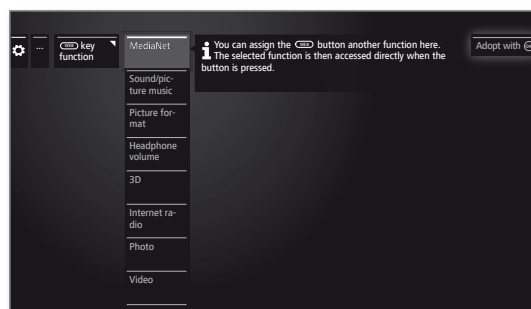

▼ ▲ Select function,
OK Adopt.

Network settings

Under Network settings you make settings to your network adaptors and the various types of media.

Call network settings

HOME

HOME: Call **Home** view.



◀ ▶ ▲ ▼ Mark **System settings**,
OK call System settings.

▼ ▲ Mark **Multimedia / Network**,
 ▶ go to next column.

▼ ▲ Mark **Network settings**,
 ▶ go to next column.

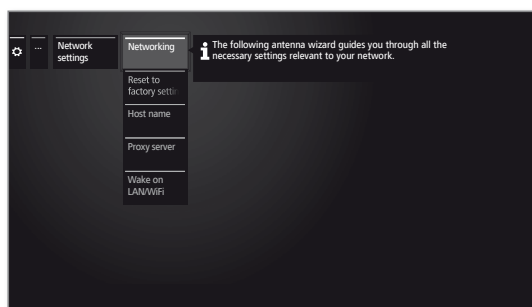

▼ ▲ Select desired menu item,
 ▶ go to next column.

Network

The network wizard guides you through all the necessary settings relevant to your network

At the beginning you see the current network status.

Network status



▶▶ Proceed to next step.

Security hint

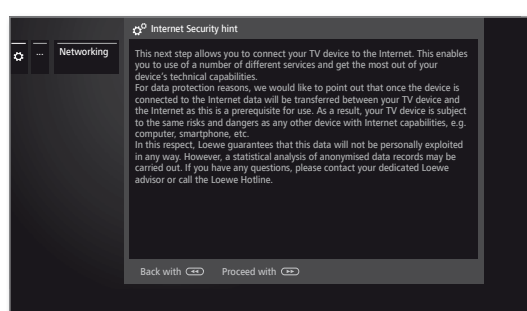

▶▶ Proceed to next step.

Network mode

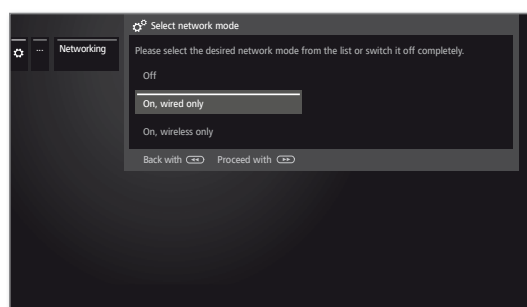

▼ ▲ Select network mode.
 Select how you want to connect your TV set to your network.
OK Confirm selection.

Off Deactivates all existing network adaptors of your TV set.

On, wired only Access to the network only via a network cable. The wireless access is deactivated.

On, wireless only Access to the network only via WLAN. The access via a network cable is deactivated.

Depending on which type of network (wireless or wired) was selected, the appropriate settings appear below.

Explanations of the setting options in the network menu:

Networking Here, the network wizard starts that guides you through all necessary settings to your network (see right hand column).

Reset to factory settings Here, all network settings are reset to factory defaults.

Host name Give your TV set a name so that it can be uniquely identified in the network.

Proxy server Do the settings for using a proxy server. The proxy server wizard will be called.
 See chapter **System settings**, section **Multimedia / Network – Proxy server** for further information.

Wake on LAN/WiFi Here you can specify whether it is permitted to access your TV set by LAN/WLAN in standby mode. This allows you to switch on your TV, for example. Please note that the TV set consequently uses more power in standby mode.

i After switching off the TV set into standby mode, it takes minimum 30 seconds for the TV set to be ready for reception of a signal (Wake on LAN/WLAN) to power on via LAN/WLAN.

i If you want to switch on your TV set via the Loewe Smart TV2move App by Wake on WLAN, you have to configure in your router's encryption permanently on WPA2. Setting WPA / WPA2 may not be used.

Configuration of the built-in LAN adaptor

As network operation was selected **On, wired only**.

IP configuration

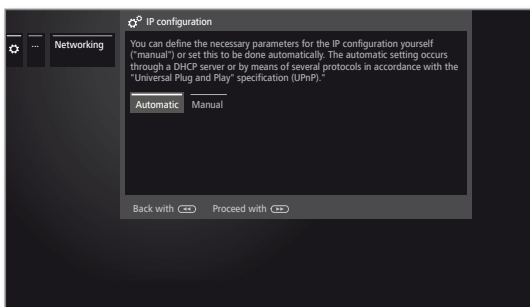

◀ ▶ Select type of **IP configuration**.

automatic Automatic configuration of the IP address via DHCP server or via multiple protocols according to UPnP specification (including DHCP).

After selecting **IP configuration – automatic** proceed to the network status.

manual Enter your fixed IP addresses manually.

If **manual** has been selected under **IP configuration**:

Manual IP-configuration

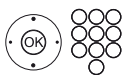
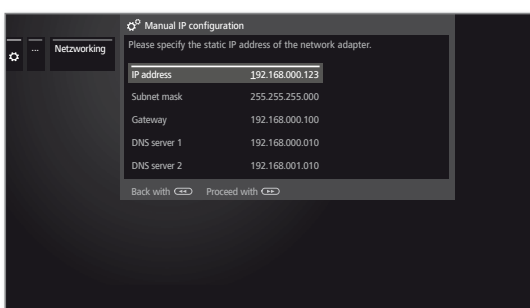

▲ ▼ Enter IP, Subnet mask, Gateway and DNS server addresses in succession with the numerical keys on the remote control.



▶▶ Proceed to **network status**.

Network status



You see the current network status again.



BACK: End of wizard.

Configuration of the built-in WLAN bridge adaptor

As network operation was selected **On, wireless only**.
 The TV set now searches for wireless routers.

Access point selection

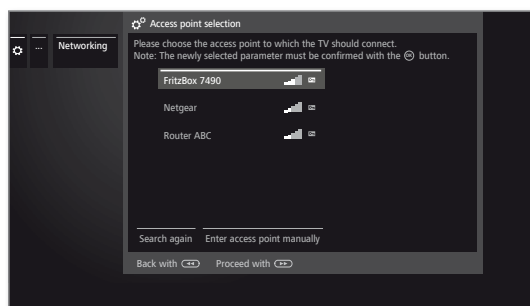

After the end of the search:

▲ ▼ Select a base station to which the TV shall be connected.

OK Confirm selection and proceed to the entry of the Wi-Fi password.

If the desired access point is not found:



◀ ▶ ▲ Mark **Search again**.

OK repeat search for wireless routers.



Or:

◀ ▶ ▲ Mark **Enter access point manually**,

OK enter manually the SSID of the desired access point, e.g., when the SSID of the access point is not transferred.

WPA passphrase

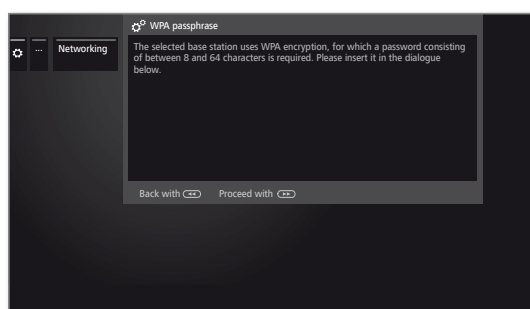

The TV set automatically detects the type of encryption used and informs you. You will find the supported encryption types in chapter **Technical data**.

If your wireless network is not encrypted: Proceed to **IP configuration**.



▶▶ Proceed to password entry.

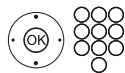

Enter WLAN password.

i In case of an unknown WLAN key, contact your network administrator.



For WEP encryption

◀ ▶ Select the **WEP index**.

OK proceed to **IP configuration**.

◀ ▶ Select type of **IP configuration**.

For the further workflow of the network wizard see left column under **IP configuration**.

Explanation of the settings in the network status:

| | |
|--------------------|--|
| Network | shows the current type of connection (wireless or wired). |
| IP configuration | The current assignment method for the IP address of your TV set (automatic or manual). |
| IP address | Your current IP address. |
| Subnet mask | Your current subnet-mask IP address. |
| Gateway | The IP address of your gateway. |
| DNS server 1 | Your current first DNS server IP address. |
| DNS server 2 | Your current second DNS server IP address. |
| Network SSID | (for wireless connection only) The name of your network. |
| MAC address (TV) | (for wired connection only) Indicates the MAC address that is built into the hardware of your TV set's wired network adaptor (LAN). |
| MAC address (WLAN) | (for wireless connection only) Indicates the MAC address that is built into the hardware of your TV set's wireless network adaptor (WLAN). |
| Connection status | Gives you information about the current status of your wireless connection (save settings, connecting, login failed, access point not found, not connected, connection established). |
| Link quality | Specifies the signal strength as a percentage. |

Proxy server

In the proxy server wizard you make arrangements for your TV set for a connection with a home network with proxy server.

- i** A proxy server is not necessary for most home networks.
- i** Contact your home network administrator if you are unclear about the proxy server settings.

Use proxy server

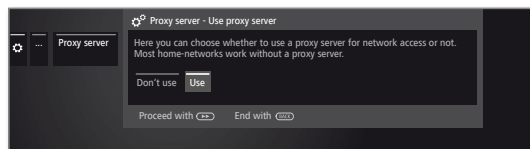

Specify if a Proxy server is used in your home network.

◀ ▶ Mark **Use** or **Don't use**.

- i** The following settings will only be requested after the selection of **Use**.



▶▶ Proceed to next step.

Proxy server name

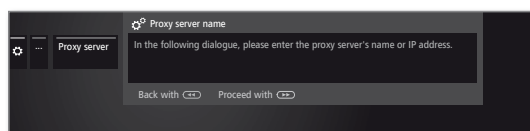

▶▶ Proceed to entry of the proxy server name.

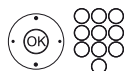

Specify the name or IP address of the proxy server used.



▶▶ Proceed to next step.

Proxy port number

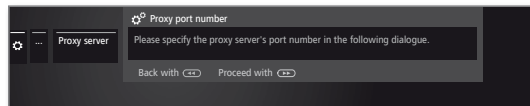

▶▶ Proceed to entry of the proxy port number.

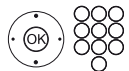

Specify the network port number of the proxy server.



▶▶ Proceed to next step.

Proxy server login

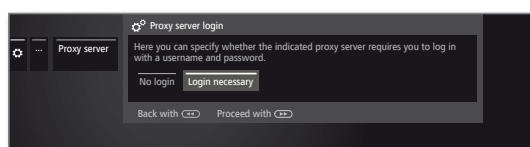

Specify whether your proxy server requires a special login.

◀ ▶ Mark **No login** or **Login necessary**.



▶▶ Proceed to next step.

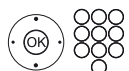

Enter your login data for the proxy server.

- i** User name and password are requested only after selecting **Proxy server login**.

Multimedia settings

Under this menu item you find further settings for Audio, Video and Photo.

Calling the Multimedia settings menu

HOME

HOME: Call **Home** view.



◀ ▶ ▲ ▼ Mark **System settings**.
OK call System settings.

▼ ▲ Mark **Multimedia / Network**,
 ▶ go to next column.

▼ ▲ Mark **Multimedia settings**,
 ▶ go to next column.

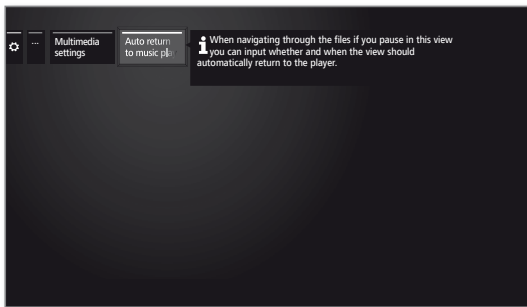

▼ ▲ Select desired settings.

Explanations of the setting options in the Multimedia settings menu:

Auto return to music player The music player will reappear whenever another dialogue, e.g., music selection is called during playback, and no keys are pressed for the set time period.
 You can specify if and after which time the music player reappears (selection options are **No**, **After 1 min**, **After 5 min**).

Renderer

Here you can allow external devices to access your TV set (renderer) via app to render (play back) contents there.

Call up renderer menu

i Default setting: **on**

HOME

HOME: Call **Home** view.



◀ ▶ ▲ ▼ Mark **System settings**.
OK call System settings.

▼ ▲ Mark **Multimedia / Network**,
 ▶ go to next column.

▼ ▲ Mark **Renderer**,
 ▶ go to next column.

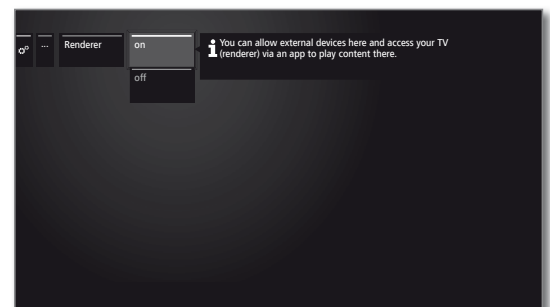

▼ ▲ Select the setting **on** or **off**.



Connections

Settings for the connection of external appliances are made in this menu.

i The menu item **Connections** is not available while a timer recording is active.

Calling the connections menu

HOME

HOME: Call **Home** view.



◀ ▶ ▲ ▼ Mark **System settings**.
OK call System settings.

▼ ▲ Mark **Connections**.
▶ go to next column.

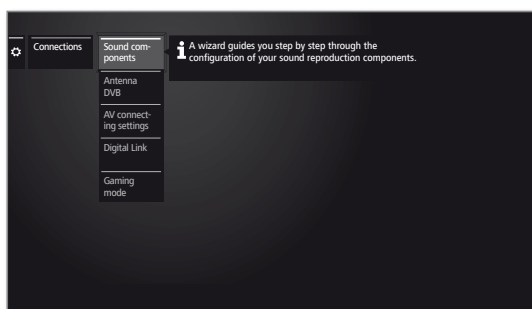

▼ ▲ Select desired settings.

Explanations of setting possibilities in the Connections menu:

Sound components The sound components wizard helps you to configure the components that are used to reproduce the TV sound.

See chapter **System settings**, section **Connections – Sound components** for further information.

Antenna DVB Here you can set the parameters of the DVB-T and the DVB-S antenna with the antenna wizard.

See chapter **System settings**, section **Connections – Antenna DVB** for further information.

AV connecting settings In the AV connecting settings the parameters for the AV connection socket can be adapted.

See chapter **System settings**, section **Connections – AV connecting settings** for further information.

Digital Link All settings for Digital Link are made here.

See chapter **System settings**, section **Connections – Digital Link** for further information.

Gaming mode Here you can set a faster display of your activities on the screen for various inputs of the TV set, e.g., for games consoles.

See chapter **System settings**, section **Connections – Gaming mode** for further information.

Sound components

The sound components wizard helps you to configure the components that are used to reproduce the TV sound. For sound reproduction, you can configure the TV loudspeakers, loudspeaker systems as well as analogue and digital HiFi/AV amplifiers.

Calling the sound components wizard

For information on navigation within the wizard, see chapter **General information on menu operation**.



HOME: Call **Home** view.



◀ ▶ ▲ ▼ Mark **System settings**, **OK** call System settings.

▲ ▼ Select **Connections**,
 ▶ go to next column.

▲ ▼ Select **Sound components**,
 ▶ go to next column.

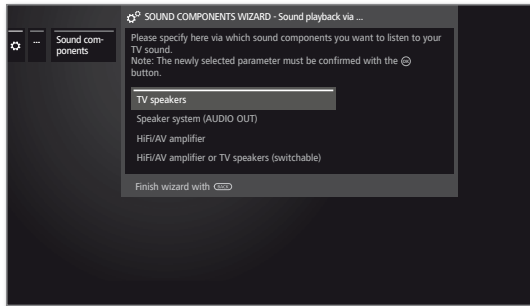

▲ ▼ Select **Sound component**.
 For selectable items see below.
OK Confirm selection.



▶▶ Proceed to next step.

Sound playback via ...

Some sound components can only be selected when the respective device is connected to the TV set.

TV speakers Sound reproduction via the built-in TV speakers (factory setting).
 With the selection of TV speakers the wizard will end.

Speaker system (AUDIO OUT) Sound reproduction via a loudspeaker system or active loudspeakers (connection to AUDIO OUT).
 How to connect a speaker system to AUDIO OUT, see chapter **External devices**, section **Connecting the speaker system (AUDIO OUT)**.

How to configure a speaker system at AUDIO OUT, see chapter **System settings**, section **Connections – Adjusting the speaker system (AUDIO OUT)**.

If a speaker system is connected to AUDIO OUT and you want to return to selecting **TV speakers**, switch the subwoofer of the speaker system off before you select the **TV speakers**. At the AUDIO OUT connection, the audio signal is output with maximum volume setting in the **TV speaker** selection.

HiFi/AV amplifier Sound reproduction via an external analogue or digital audio amplifier.

How you connect a HiFi/AV amplifier see chapter **External devices**, section **Connecting the HiFi/AV amplifier**.

How you configure a HiFi/AV amplifier see chapter **System settings**, section **Connections – Adjusting the HiFi/AV amplifier**.

HiFi/AV amplifier or TV speakers (switchable) Sound reproduction optionally via an external analogue or digital audio amplifier or via the built-in TV loudspeakers.

The selection options for switching between sound components can be called via the function list under **Sound settings**.



Adjusting the speaker system (AUDIO OUT)

Sound playback via ... – Speaker system (AUDIO OUT)¹

Enter here that you want to hear the TV sound via a speaker system connected to AUDIO OUT.

i For information on navigation within the wizard, see chapter **General information on menu operation**.

i Speaker system (AUDIO OUT) was selected in the Sound components wizard. Afterwards you can switch on the power switch of the subwoofer.

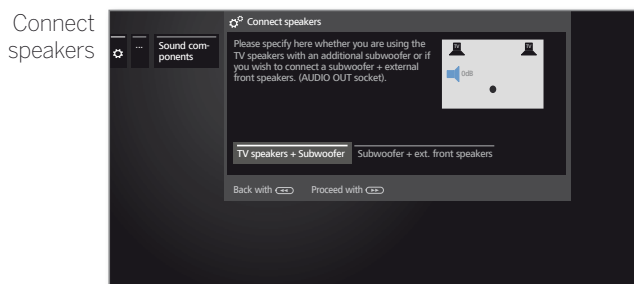

◀ ▶ Select **TV speakers + Subwoofer** or **Subwoofer + ext. front speakers**.

Specify here whether you want to operate the speakers of the TV set with an additional subwoofer or a subwoofer with external front speakers at the AUDIO OUT socket of the TV set.



▶▶ Continue with the appropriate selection.

TV speakers + Subwoofer

Adjust subwoofer level

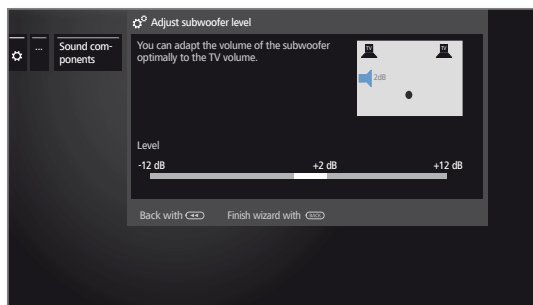

◀ ▶ Adjust the volume for the subwoofer.



Back: Finish wizard.

This ends the sound components wizard for connecting and setting up a speakers system.

Subwoofer + ext. front speakers

TV loudspeakers as centre speaker

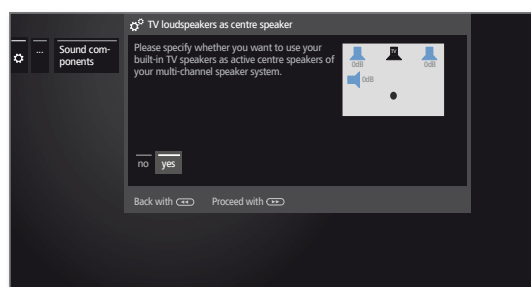

◀ ▶ Select **yes** here if you want to use the built-in TV speakers as centre speakers.

If you select **no** here, the external front speakers also transmit the centre sound parts additionally.



▶▶ Proceed to **Adjust ext. Speakers level**.

Adjust ext. Speakers level

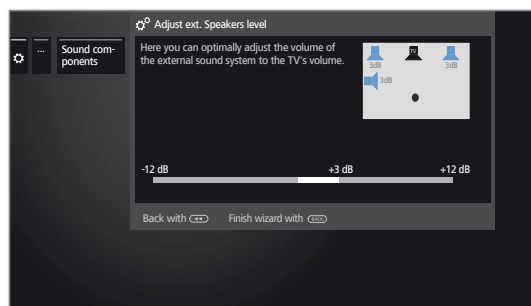

◀ ▶ Adjust the volume of the ext. sound system optimally to the TV volume.

i An audio broadband signal is transmitted via the AUDIO OUT jack. Therefore, the level of the front speakers and the subwoofer varies uniformly with the volume setting.



Back: Finish wizard.

This ends the sound components wizard for connecting and setting up a speakers system.

Adjusting the HiFi/AV amplifier

Sound playback via ... - HiFi/AV amplifier

The sound components wizard permits configuration of different audio amplifiers (stereo amplifiers, surround amplifiers, analogue or digital) with different digital audio formats (Dolby Digital, dts, MPEG, and stereo/PCM). See the user guide of the audio amplifier for more information.

i For information on navigation within the wizard see chapter **General information on menu operation**.

HOME

HOME: Call **Home** view.



◀ ▶ ▲ ▼ Mark **System settings**.
OK call System settings.

▲ ▼ Select **Connections**.
 ▶ go to next column.

▲ ▼ Select **Sound components**.
 ▶ Call sound components wizard.

Sound reproduction via ...

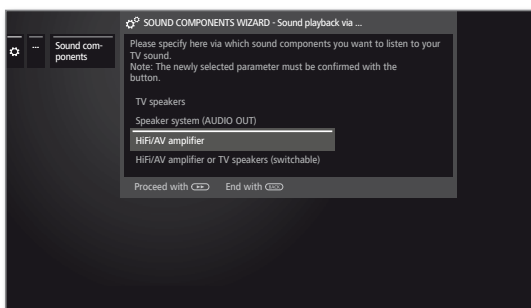

▼ ▲ Mark **HiFi/AV amplifier** or **HiFi/AV amplifier or TV speakers (switchable)**.
OK Confirm selection.

HiFi/AV amplifier Select setting when an amplifier is connected and the TV speakers are not used.

HiFi/AV amplifier or TV speakers (switchable) Select setting when an amplifier is connected and the TV speakers are used. In the sound mode selection the audio reproduction can then be switched between the amplifier and the TV speakers.



▶▶ Proceed to next step.

Type of sound transmission

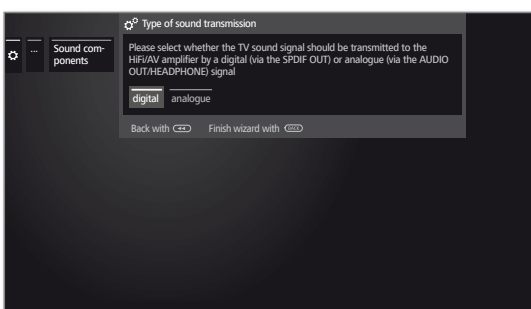

◀ ▶ Select whether the sound is to be transmitted digitally or analogue to the the amplifier (see right hand column):

digital: Proceed to **Sound formats**.
analogue: proceed with **Finish wizard**.

Sound formats

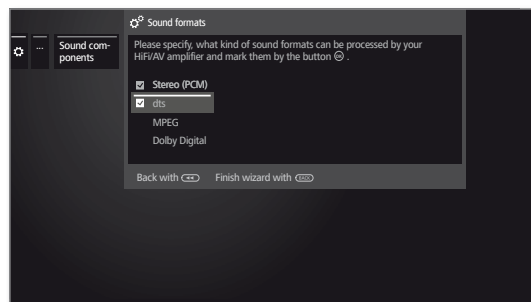

▼ ▲ Select sound formats which can be decoded with the digital amplifier (see operating manual of the used amplifier).

OK adopt sound formats.



Back: Finish wizard.



Antenna DVB

Here you can make settings for the DVB-T antenna and call the antenna wizard for the DVB-S antenna.

Call Antenna DVB

HOME

HOME: Call **Home** view.



◀ ▶ ▲ ▼ Mark **System settings**.

OK call System settings.

▼ ▲ Mark **Connections**,

▶ go to next column.

▼ ▲ Mark **Antenna DVB**,

▶ go to next column.

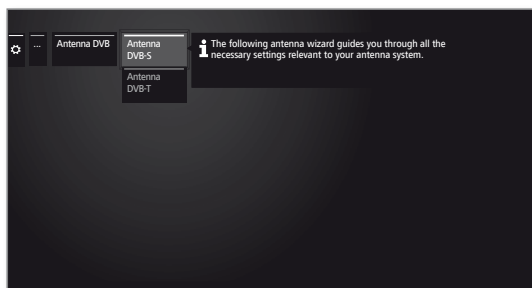

▼ ▲ Select the desired setting,

▶ call.

AV connection settings

In the AV connection settings menu the parameters for the AV connection socket can be adapted.

Calling the connections menu

HOME

HOME: Call **Home** view.



◀ ▶ ▲ ▼ Mark **System settings**.

OK call System settings.

▼ ▲ Mark **Connections**,

▶ go to next column.

▼ ▲ Mark **AV connecting settings**,

▶ go to next column.

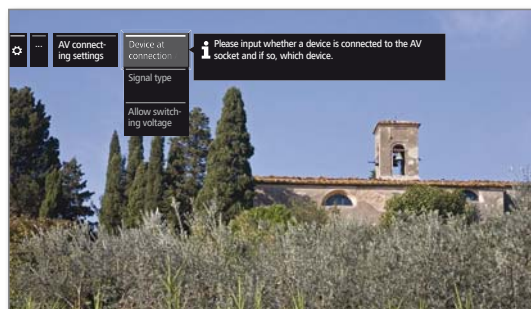

▼ ▲ Select the desired setting,

▶ call.

Explanations of the setting options in the antenna DVB menu:

Antenna DVB-S Here the antenna wizard starts guiding you through all the settings relevant to the DVB-S antenna. The settings of the DVB-S antenna wizard are explained in the procedure of initial installation.

Antenna DVB-T Here you can set whether your DVB-T antenna needs a supply voltage.

Antennas with an integrated amplifier need a supply voltage on the antenna line. In this case, select **Supply voltage 5V** and confirm with **OK**.

Otherwise, select **No supply voltage** and confirm also with **OK**.

Positioning/aligning DVB-T antenna

If you are receiving one or more DVB-T stations with picture and sound interference then you should change the installation location and alignment of the antenna. Ask your dealer to tell you which channels are used to broadcast the DVB-T stations in your region.

A DVB-T station is received and selected.

Calling manual search (see chapter **System settings**, section **Stations – Manual TV/Radio scan**).

Due to the preset stations, the signal source is already selected as DVB-T. Position and align the antenna so that maximum **C/N** values and **levels** are reached.

Search for DVB-T stations one after the other and compare values for **C/N** and **Level**. Then position/align the antenna to the weakest station so that maximum values for **C/N** and **Level** are obtained. The value for **BER** should be as low as possible.

Thereafter, perform an automatic search for all DVB-T stations.

Explanations of setting possibilities in the AV connecting settings menu:

Device at connection AV Indicate here whether a set and, if yes, which one is connected to the **AV** socket.

Signal type You set the signal type of the device connected to **AV** here. You can find out more from your dealer.

Allow switching voltage If this function is activated, the video and audio of an external unit connected to the **AV** connector (not at AVS) will immediately be reproduced on all TV broadcast sites when playback is started up, provided that the external unit supplies a switching voltage.

Digital Link

In the digital link menu you make further setting for comfortably linking external devices to the TV set.

Call Digital Recorder Link menu



HOME: Call **Home** view.



◀ ▶ ▲ ▼ Mark **System settings**.
OK call System settings.

▼ ▲ Mark **Connections**,
 ▶ go to next column.

▼ ▲ Mark **Digital Link**.
OK call Digital Link.



▼ ▲ Select the desired setting,
 ▶ call.

Explanations of the setting options in the Digital Link menu:

Digital Link HD functionality Herewith you can allow or forbid the automatic communication between the TV set and linked external devices (e.g., BluRay player). Among other things, it's role is that these devices switch mutually on and off.

Remote switch on of the TV set Here you can select whether the TV set is to switch on automatically from Standby mode, if **Digital Link HD** or **Digital Link Plus** capable devices connected to an HDMI or to AV inputs start playback or display a screen menu.

i Menu item only available if at **Digital Link HD - Functionality → on** has been selected.

Shutdown of the ext. device via TV button You can select here whether the external **Digital Link HD** device that is currently playing back should be automatically shut down as soon as you switch back to the TV or another AV channel.

i Menu item only available if at **Digital Link HD - Functionality → on** has been selected.

Gaming mode

For the inputs of your TV set on which game consoles, PC applications or even Karaoke machines are operated, we recommend you to activate the **Gaming mode**.

Your activities are then displayed quicker on the screen by reducing the complex picture improving techniques.

This mode can be set separately for every input of your TV set.

Call Gaming mode menu



HOME: Call **Home** view.



◀ ▶ ▲ ▼ Mark **System settings**.
OK call System settings.

▼ ▲ Mark **Connections**,
 ▶ go to next column.

▼ ▲ Select **Gaming mode**.
OK call.

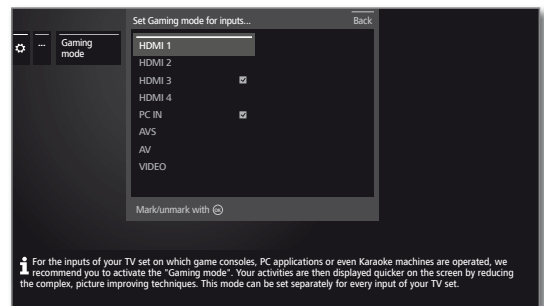

▲ ▼ Select connection,
OK Gaming mode for selected connection on/off.

You can recognise AV connections with set Gaming mode by the symbol after the connection name. A dice icon is shown in the extended station list behind the corresponding AV input when filtering on the AV list.

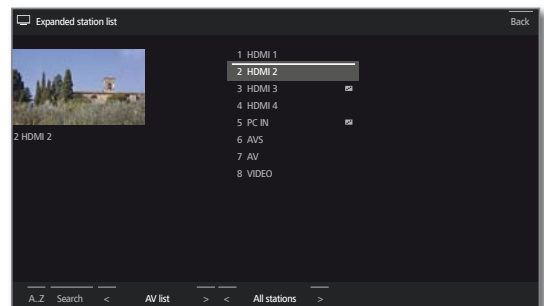

Extras

Extras contains additional functions and settings (e.g., Integrated features, Repeat initial installation, CA module settings).

Call Extras



HOME: Call **Home** view.



◀ ▶ ▲ ▼ Mark **System settings**.

OK call System settings.

▼ ▲ Mark **Extras**.

▶ go to next column.



▼ ▲ Select the desired setting.

▶ call.

Explanation of the subitems of Extras

Integrated features Call information on the integrated features of the TV set (see next page).

Repeat initial installation You can repeat the Initial installation again at any time. You are guided through the various menus where i.a. an automatic TV/radio station search is automatically carried out.

Caution: All stored stations and all created personal lists will be deleted by this!

i If a parental lock is activated, the access code must be entered before repeating initial installation.

Reset to factory settings Resetting various settings to their factory defaults (see next page).

CA module [Name] Make settings for your CA modules.

i This menu item appears only if at least one CA module is plugged in.

i The exact designation of the menu item and available subitems depends on your CA module(s).

See chapter **System settings**, section **Extras – CA module** for further information.

Integrated features

Here you can obtain information on the integrated features of the TV set.

i See the rating plate on the rear of the set for the precise product designation.

Call Integrated features

HOME

HOME: Calling the **Home** view.



◀ ▶ ▲ ▼ Mark **System settings**.
OK call System settings.

▼ ▲ Mark **Extras**.
 ▶ go to next column.

▲ ▼ Mark **Integrated features**.
OK call Integrated features¹.

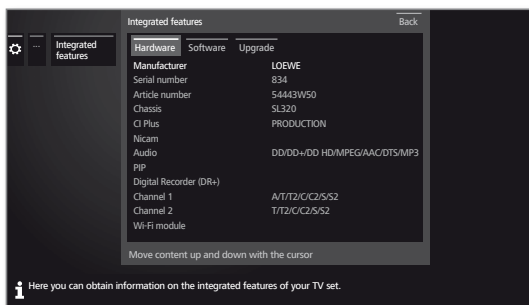

◀ ▶ ▲ ▼ Select category (e.g. hardware, software, etc.).
 ▲ ▼ If necessary, scroll content up/down.

Hardware Under the Hardware item, you can find the article and serial number of your TV set, the MAC address and the chassis type with all existing hardware components.

Software Under the item software, the current software version and the installed software features of your TV set are displayed.

Upgrade Under the item Upgrade you can find the installed software features with their respective status.

Activated: software feature is installed and can be used.

Not active: software feature is installed, but can not be used.

Reset to factory settings

Here you can reset some of the settings to the factory default values.

Call Reset to factory settings

HOME

HOME: Calling the **Home** view.



◀ ▶ ▲ ▼ Mark **System settings**.
OK call System settings.

▼ ▲ Mark **Extras**.
 ▶ go to next column.

▲ ▼ Mark **Reset to factory settings**.
OK call.



▲ ▼ Select a category you want to reset,
OK call.

◀ ▶ Select **Start reset**.
OK call.

Entire TV Set This resets the entire TV set to factory defaults. By resetting the entire TV set to the factory default state, all the settings you made and all stored stations will be deleted. Thereafter, an initial installation of the TV set is carried out again (see chapter **Initial installation**).

Picture/sound The current image and sound parameters of your TV set will be deleted and reset to the factory defaults.

Network The current network settings of your TV set will be deleted and reset to the factory defaults.

HDMI The HDMI setting is reset to the factory settings.

Browser The current browser settings of your TV set will be deleted and reset to the factory defaults. All data stored in the course of use are deleted.

Media data base Your current media database is deleted because the database is reinitialised. The information from the removable media (USB) and possibly the DR+ archive are then re-read. The system then automatically performs a system reset.

¹ The screen graphic displayed is only an example. Depending on the device type, the available hardware/software components may be different.

Common Interface (CI / CI Plus)

Common Interface, also called CI, is a interface in the TV set, into which a Conditional Access Module (CA module, see right column) can be plugged. The CA module and the smartcard from a corresponding Pay TV supplier enable reception of encrypted stations.

CI Plus is an advanced development of the DVB Common Interface Standard. CI Plus slots are in principle downward compatible to the previous CI standard, i.e. CA modules and Smart Cards according to the past CI standard can continue to be used in CI Plus slots, as far as the programme provider permits this.

Programme providers who use the CI Plus standard can assign different rights for their broadcast programmes.

For instance, the programme provider can restrict or completely prevent recording or later watching of an encoded programme. If there are such regulations, these also apply to timeshift television accordingly.

A screen message informs you of this fact, if you would like to record such a programme. Recording is carried out in such a case (an appropriate entry is displayed in the DR+ archive), later watching of the programme, however, is not possible at all or only for a limited period (e.g., 10 days).

A possible time limitation of the playback will also appear in the corresponding entry in the DR+ archive.

i All restrictions mentioned here are the responsibilities of the broadcaster. The TV simply values the signalling set by the broadcaster as neutral.

Furthermore, the programme provider can prevent external copying of protected programmes.

It could be necessary to enter the youth protection PIN of the CA module when programming the data, if you want to record a CI Plus protected programme, which has been protected against viewing by minors.

The Parental lock PIN can also be stored in the TV set. The access code of the TV set is required for watching the programme later.

Software update for CI Plus capable CA modules

From time to time, there will be new system software for your CA module software. There are two software update types.

Recommended update:

Information on an available update is displayed. You can either run this or cancel the procedure. If you do not install the update, the information will reappear in regular intervals until the update has been installed.

Forced update:

Information on an available update is displayed. The module does no longer decode until the update has been successfully implemented.

Conditional Access module (CA module)

In order to receive coded digital stations, a Conditional Access module (CA module) and a Smart Card must be inserted in the CI slot of your TV set.

The CA module and the Smart Card are not part of the set of equipment supplied with the TV set. They are usually available from your dealer. Loewe does not provide any guarantee for the functioning of the CA module.

The TV set must first recognise and set up the CA module during initial operation. Therefore, it can take up to a minute until decoding starts during initial operation.

Inserting the Smart Card into the CA module

Push the Smart Card into the CA module as far as it will go. The side of the card with the gold chip on it should be pointing towards the thicker side of the insertion slot (see illustration). Note the direction of the arrow printed on the Smart Card.

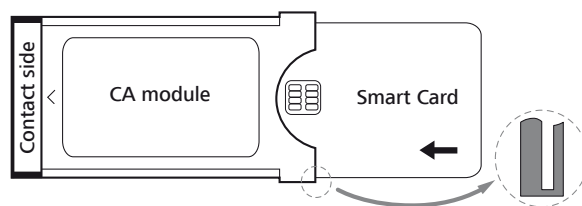

Inserting the CA module into the TV set's CI slot

i Switch off TV set using the mains switch.

Remove the cover from the rear of the set.

Insert the CA module carefully into one of the two CI slots, ensuring that the contact side goes in first. Do not use force. Make sure the module is not twisted in the process. Push the CA module in as far as it will go.

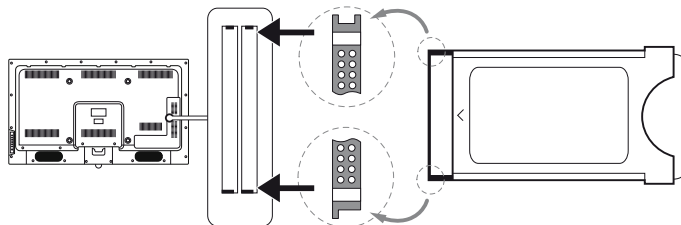

Finally, close the side cover.

Troubleshooting (CA module)

The following information can help, if problems should occur when running a CA module:

Switch the TV set off to the standby mode. Remove the CA-module from the TV set. Switch the TV set off completely. Wait a few seconds. Reinsert the CA module. Switch the TV set on again.

Should errors continue to occur, you will get further information resulting from the two-digit error code (only with CI Plus capable CA modules). You will find the table with the error codes in chapter **Miscellaneous**, section **CA module error codes**. If in doubt, contact your dealer.

Searching for scrambled stations

If no search for encrypted stations was performed during initial startup, this can be done later using the search wizard.

HOME



HOME: Call **Home** view.

◀ ▶ ▼ ▲ Select **System settings**.

OK call System settings.

▼ ▲ Mark **Stations**.

▶ go to next column.

▼ ▲ **Automatic scan TV+Radio**.

▶ go to next column.

◀ ▶ Select **Change search settings**.

OK wizard guides you through the search settings.

i Under **scrambled stations** you have to select **yes**.

◀ ▶ Next select **Start search/update**.

OK start updating the station list.

Calling CA module information

i This menu is only available when a CA module is plugged in.

HOME



HOME: Call **Home** view.

◀ ▶ ▲ ▼ Mark **System settings**.

OK call System settings.

▼ ▲ Mark **Extras**.

▶ go to next column.

▼ ▲ Select desired CA module.

i The indicated name depends on the inserted CA module.

▶ go to next column.

▼ ▲ Select **Module menu**.

OK call information.

The content of this menu depends on the provider of the CA module.

Smartcard rights

If two CA modules are used in parallel to decode stations, you specify here the rights of both smartcards.



▼ ▲ Mark **Smartcard rights**

▶ go to next column.

▼ ▲ Select **Same rights** or **Different rights**.

If you select **Same rights**, the TV set assumes that both smartcards have the same rights and can be used for Dual Recording in parallel. In this case, the **Station mapping** function is not available.

When selecting **Different rights**, you can assign the stations to be decoded to the respective CA module.

Station mapping

If two CA modules are both used for the decoding of stations, you decide here which station shall be decoded by which CA module.

i The station mapping settings will only be taken into account, if two CA modules are plugged.

i This menu item is only available if under **Smartcard rights** the item **Different rights** was selected.

i This statement refers explicitly to the CI slots of the TV set and **not** to the modules plugged into it! When the modules are exchanged, the mapping must be repeated.



▼ ▲ Mark **Station Mapping**.

▶ call station list.

◀ ▶ ▼ ▲ Select CA module for mapping.

◀ ▶ ▼ ▲ Mark station,

OK map station to the selected CA module / cancel mapping.

Behind the assigned station is the number of the corresponding CI slot.

Storage the PIN for recordings

Store the programme provider PIN belonging to your CA module in order to decode CI plus programmes with parental lock for recording.

i The menu option is available only if the plugged CA module supports storing the parental lock PIN.



▼ ▲ Mark **Storage of PIN for recordings**.

▶ call PIN entry box.

◀ ▶ ▼ ▲ Mark the desired CA module in the headline.

▼ Go to the PIN input line, use the numerical keys to enter the programme provider PIN.

Or:



◀ ▶ ▼ ▲ Mark figure,

OK adopt figure to input line.

To conclude the entry:



◀ ▶ ▼ ▲ Mark **Adopt**.

OK save PIN.

Removing the CA module

i Switch off TV set using the mains switch.

Remove the cover from the rear of the set.

Pull the CA module out of the CI slot.

Replace the cover.

Devices to the HDMI connections

The HDMI connections (High Definition Multimedia Interface) allow the transmission of digital video and audio signals from a player (e.g. DVD player, Blu-ray player, game console, camcorder, set-top box) via a single cable.

The digital video and audio data are transmitted without data compression digitally and therefore lose none of their quality.

A maximum of five devices can be connected in cascade to every HDMI socket. The devices are arranged in the AV list and in the station list below the appropriate HDMI socket. If the respective device sends its own device name, this appears in place of the connection name.

Connecting the device

Switch off all devices before connecting them.

Connect the device by an HDMI cable (Type A, 19-pole) to one of the **HDMI** sockets of the TV set.

An HDMI device is connected to the side HDMI socket (e.g. camcorder) in the same way as shown in the figure.

i Please note that not all signals may be represented on any HDMI socket (see chapter **Technical Data**, section **Signals via AV (PC IN) / HDMI**)

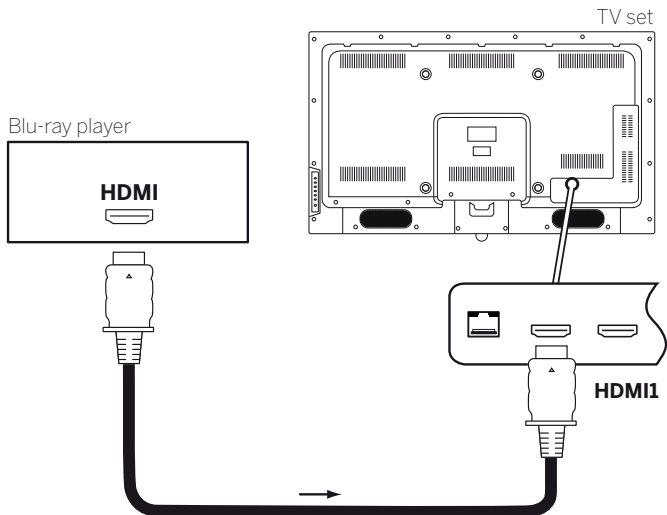

Connection example of an HDMI device (e.g. Blu-ray Player)

Playback from the device

If the device at **HDMI** supports the **Digital Link HD** functionality, the TV set will automatically switch to the corresponding HDMI input after starting the replay at the HDMI device.

The HDMI input can also be called up manually:



Call **AV list**.

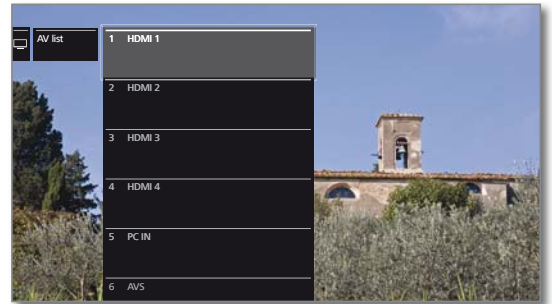

▲ ▼ Select **HDMI** socket.

With **Digital Link HD**-capable devices the device name may possibly appear in place of the connection name.

OK switch over.

Start playback on the connected HDMI device. The best possible format for the picture is detected and set automatically.

Renaming the HDMI port designation

The port designation of the HDMI jacks can be renamed manually.



Call **AV list**.



▲ ▼ Select desired **HDMI** socket.

OK switch over.



MENU: Call function list.



▲ ▼ Select **Rename**.

OK call.



Enter new name (information on how to enter characters, see also section **General information on operation**, section **Entering characters with on-screen keyboard**).



◀ ▶ ▲ ▼ Select adopt.

OK New name for the HDMI jack is adopted.

Digital Link HD

Operation of Digital Link HD (HDMI CEC) enabled devices

The **Digital Link HD** (HDMI CEC) function allows Loewe television sets to transmit the remote control signals via the HDMI connection of the TV set to compatible HDMI devices (such as Loewe BluTechVison 3D). You can therefore set up and use a concealed CEC capable HDMI device.

Thus, you can install a concealed CEC-enabled HDMI device and operate it easily.

You can select and operate the CEC-capable HDMI device in two different ways. On the one hand, by using a device key (**STB**, **VIDEO** or **AUDIO**) to switch to the operation of the HDMI device. On the other hand, by using the TV key to switch between HDMI device and the TV set.

Switching between operation of TV set and HDMI device using a device key

Assign the **HDMI CEC function** (code **22**) to the desired device key (**STB**, **VIDEO** or **AUDIO**). The assignment is described in chapter **External devices**, section **Setting the remote control – Setting the remote control for other Loewe devices**.

Subsequently, the assignment of the HDMI device used to the preset device key will be done.

i The CEC capable HDMI device is connected to one of the HDMI sockets of the TV set and switched on.

STB **VIDEO** **AUDIO** Press required button for 5 seconds.

A selection menu appears on the TV set.

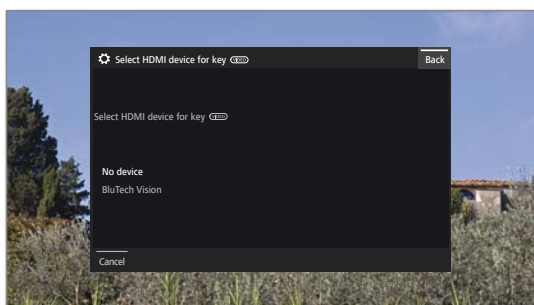

▲ ▼ Select required device from the list.

OK Accept.

The assignment of the device key and the assignment of the HDMI device are completed.

STB **VIDEO** **AUDIO** Press the corresponding device key to switch to the operation of the HDMI device. The remote control commands are routed from the TV set to the HDMI device.



Press the TV key to switch to the operation of the TV set.

If the Auto off function (see right column) is enabled, the HDMI device switches off.

Switching between operation of TV set and HDMI device using the TV key

i Switching the control via the TV key is only possible when no device key is assigned to the HDMI device you are using.



Call **AV-List**.



▲ ▼ Select a **HDMI** socket to which the HDMI device is connected.



Pressing **TV** for a longer period: switch remote control commands between HDMI and TV operation.

A message on the screen informs you about the currently selected mode.



Pressing briefly **TV**: Switch to TV mode (back to previous station).

Automatically switching off external devices

When returning to TV mode by briefly pressing the **TV** key the external device can be switched off.

You can find the settings in the **System settings** → **Connections** → **Digital Link** → **Shutdown of the ext. device via TV button**.

i Menu item only available if at **Digital Link HD - Functionality** → **on** has been selected.

Remote switch on of the tv set

You can select whether the TV set is to switch on automatically from Standby mode if a disc is played or a screen menu displayed on a **Digital Link HD**-enabled device.

You can find the settings in the **System settings** → **Connections** → **Digital Link** → **Remote switch on of the tv set**.

i Menu item only available if at **Digital Link HD - Functionality** → **on** has been selected.

Switching off the TV set and connected devices (system standby)

i The operation of the TV set must be enabled (see above).



Press the key briefly: TV set and all CEC-enabled devices connected to the **HDMI** ports will be switched off to standby (system standby).

Devices on AV

The **AV** connection socket offers the possibility to connect e.g. a DVD player, video/DVD recorder or PC via two different adapters.

The required adapters (Scart or VGA adapter) are available as an accessory from your Loewe dealer (see chapter **Accessories**).

The AV sockets can process different signal types. Which signal type your accessory device provides can be found in the operating manual of the appropriate device.

Owing to the large number of AV devices available on the market, we can only mention a few examples for the connection of accessory equipment to the AV socket here.

Remote TV switch on via Digital Link

You can select whether the TV set is to switch on automatically from Standby mode if a disc is played or a screen menu displayed on a **Digital Link Plus-enabled** device connected to **AV**.

You can find the settings in the **System settings → Connections → Digital Link → Remote switch on of the TV set**.

Connecting a DVD player to the TV set

■ A **DVD player** has been selected in the **System settings → AV connecting settings → Device at connection AV**.

Switch off all devices before connecting them.

Connect the Scart output of the DVD player to the TV set's **AV** socket using the Scart adaptor ¹.

Use a fully equipped Scart cable (available from your dealer) for this.

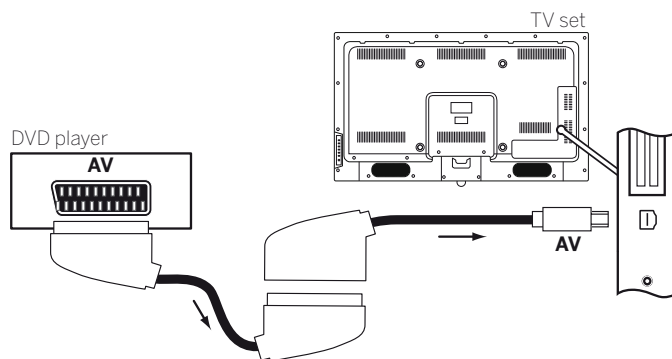

Connection example of a DVD player

Playback from AV device

If the device at AV supports the Digital Link Plus functionality or if in the **System settings → Connections → AV connecting settings → Allow switching voltage → yes**, the TV set will automatically switch to the corresponding AV input after starting the replay at the AV device.

The AV input can also be called manually, however.



Call **AV list**.

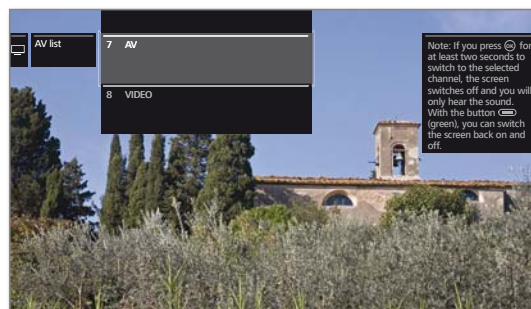

▲ ▼ Select **AV**,
OK switch over.

Start playback on the connected device.

¹ Adaptor is available as an accessory (see chapter **Accessories**).

Connecting a DVD recorder to the TV set

i A DVD recorder has been selected in the **System settings** → **Connections** → **AV connecting settings** → **Device at connection AV**.

Switch off all devices before connecting them.

Connect the Scart output of the DVD player to the TV set's **AV** socket using the Scart adaptor ¹. Use a fully equipped Scart cable (available from your dealer) for this.

If you want to receive and record analogue stations with the receiver (tuner) built into the recorder, the recorder must be looped into the aerial cable.

Connect the DVD recorder as shown in the connection example below.

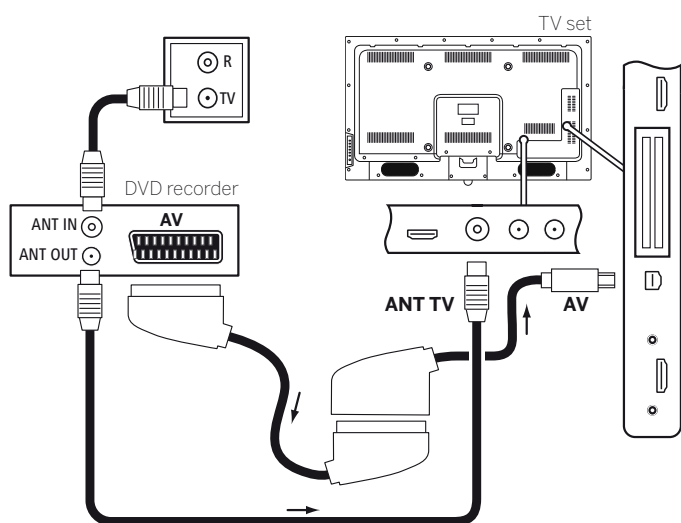

Connection example of a DVD recorder

Playback from AV device



Call **AV list**.

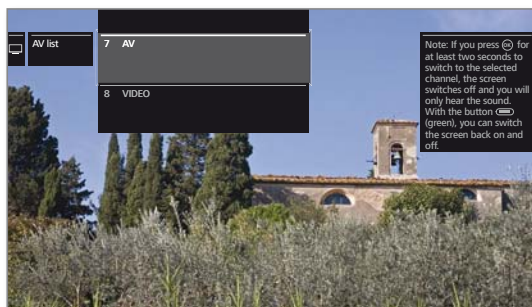

▲ ▼ Select **AV**.
OK switch over.

Start playback on the connected device.

Connecting PC / Set-top box

You can connect a PC and thus use the TV screen as a monitor.

i When connecting a PC or auxiliary device to the **AV** socket of the TV set, adjust the output signal on your PC first so that it matches one of the signals in the table in chapter **Technical data**, section **Signals via AV (PC IN) / HDMI**.

Switch off all devices before connecting them.

Connect the device to the TV set's **AV** socket with a VGA cable and the VGA adaptor ¹.

Connect the analogue audio signal of the PC to the VGA adaptor via the jack plug socket.

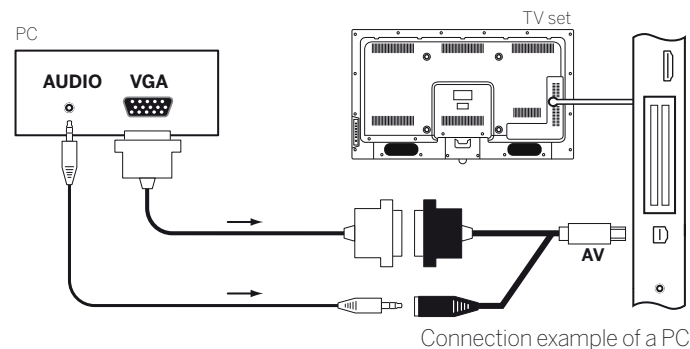

Connection example of a PC

Playback from the device



Call **AV list**.

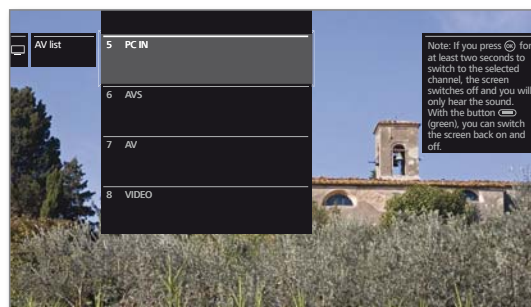

▲ ▼ Select **PC IN**.
OK switch over.

Adjusting the geometry of the PC picture

You can set the position (vertical, horizontal) and the phase position of your PC. The settings you find under **System settings** → **Picture** → **more ...** → **PC IN - Display**.

Connecting devices with component connection (YPbPr / YUV)

External units with component connection **YPbPr** (often informally referred to as **YUV**; see also **Glossary**) can be connected to the **AV** socket of the TV set using two adaptors. In addition to the VGA adaptor, a component VGA adaptor is required (available from your dealer).

The other units are connected as described in the left column.

¹ Adaptor is available as an accessory (see chapter **Accessories**).

Connecting the speaker system (AUDIO OUT)

You can easily connect a speaker system using the **AUDIO OUT** interface of your TV set.

Switch off all devices before connecting the speaker system.

The subwoofer is connected to the TV set via the **AUDIO OUT** interface.

Connect the analogue audio output **AUDIO OUT** of the TV set with a stereo cinch/jack adaptor cable to the Line IN audio inputs left/right of the subwoofer.

Further information on the wiring of the speakers you find in the instruction manual of the subwoofer or the speakers.

i Only turn in the power switch of the subwoofer after having selected the menu item **Speaker system (AUDIO OUT)** in the Sound Component Wizard. Otherwise, the sound system will operate with maximum volume.

i If you are using a speaker system at the AUDIO OUT jack, the headphone volume can no longer be controlled separately.

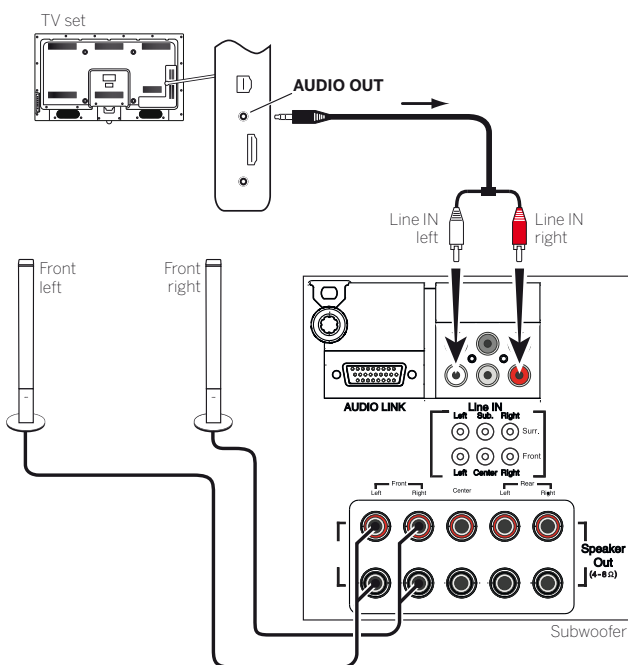

Example of connecting a speaker system to your TV set

Configuration of the speaker system (AUDIO OUT)

When configuring the sound system in the sound components wizard enter if you want to use e.g. external front speakers or how the TV speaker is used (see chapter **System settings**, section **Connections – Sound components**).

i Only turn in the power switch of the subwoofer after having selected the menu item **Speaker system (AUDIO OUT)** in the Sound Component Wizard. Otherwise, the sound system will operate with maximum volume.

Connecting the HiFi/AV amplifier

Connecting digital HiFi/AV amplifiers

Connect the digital audio output of the TV set **SPDIF OUT** to the digital audio input of the amplifier via a cinch cable:

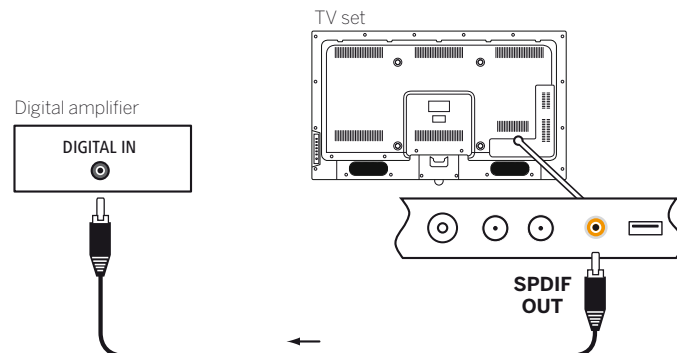

Connect digital audio (pre) amplifier via audio return channel (HDMI ARC)

Connect the **HDMI1** socket of the TV using an HDMI cable with the HDMI socket of the ARC-compatible audio (pre) amplifier (e.g. **Loewe MediaVision 3D**). It is not necessary to log-in the amplifier separately with the TV set.

Connecting analogue HiFi/AV amplifiers

Use a stereo cinch/jack adaptor cable to connect the analogue audio output **HEADPHONE** to the analogue audio input of the amplifier:

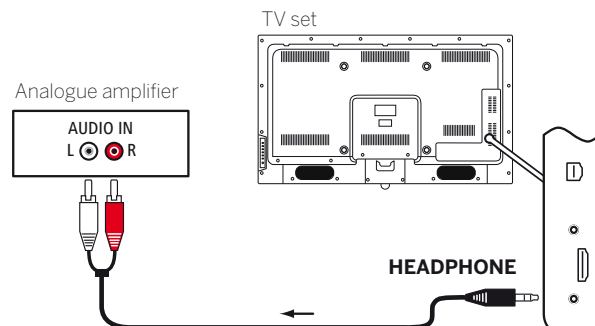

Reproducing sound via an HiFi/AV amplifier

The sound reproduction via connected HiFi/AV amplifiers can be adjusted in the sound components wizard (see chapter **System settings**, section **Connections – Sound components**).

Audio playback from external devices

Connect external AV devices (e.g., MP3 player) for sound reproduction to the AV inputs of the TV set.

Connecting an external appliance (e.g. MP3 player)

Connect the output (jack socket) of the MP3 player via the VGA adaptor¹ to the **AV** socket of the TV set.

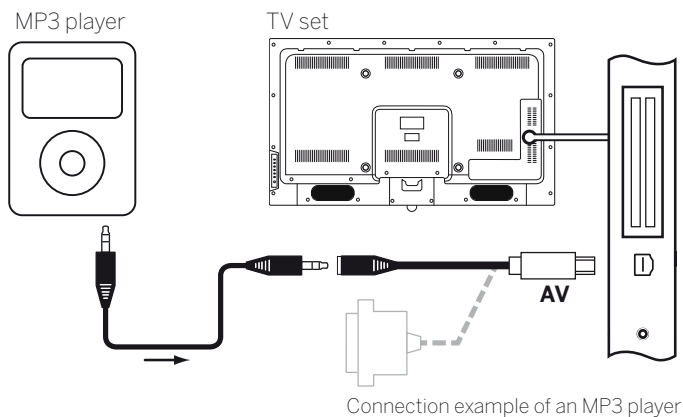

Select AV input

The selection of the AV input for a device at the **AV** socket (connection as described above) is describe here as an example. The procedure is similar to the selection of the other AV inputs.



Call up the **AV list**.

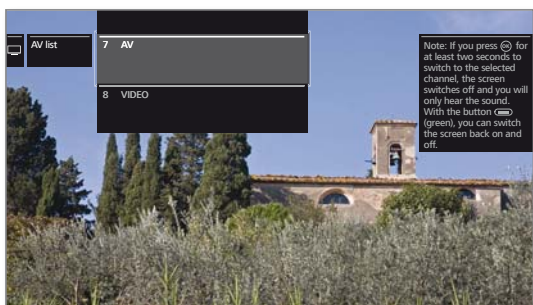

▼ ▲ Mark desired AV source, **OK** switch to AV source.

Start playback on the external device after selecting the AV input.

Only playback of the audio signal from the AV source (screen is off)

To play only the sound of a connected media player (e.g. MP3 player), the AV sources can be selected so that the screen goes blank.

Switching off the screen reduces the power consumption of the TV set.

Switching off the screen is possible for the AV sources HDMI1, HDM2, HDM3 and HDMI 4 UHD via the function list.



Call up the **AV list**.



▼ ▲ Select desired connection, **OK** press at least for two seconds.

 **Green key:** Press the green key to switch the the screen on and off again.

¹ Adaptor available as an accessory (see chapter **Accessories**).

Setting the remote control

Using the remote control for the TV mode of the TV set

TV Press the **TV key**, the LED above it will light for approx. 5 seconds.

Using the remote control for a Loewe recorder

STB Press the **STB key**, the LED above it will light for approx. 5 seconds.

Using the remote control for a Loewe player

VIDEO Press the **VIDEO key**, the LED above it will light for approx. 5 seconds.

Using the remote control for the radio mode of the TV set

AUDIO Press the **AUDIO key**, the display above it will light for approx. 5 seconds.

As long as a key is pressed, the LED for the selected operating mode lights up (**TV** – **STB** – **VIDEO** – **AUDIO**). This allows you to check which operating mode the remote control is set to every time you press a button.

The **factory setting** of the keys is described above (see also table in right hand column). The assignment of the buttons can be changed to suit the existing accessory devices (see right hand column).

Set unit for sound control function on the remote control

The keys for the sound control functions Volume (10) and Sound on/off (1) are programmed ex-factory to interact with the TV set. The unit to be operated can be modified.

■ The device must **first** be placed on one of the device key of the remote control (see right column) before the tone-control functions can be changed to the appropriate device.

TV **3 def** Press the **TV key** and the numerical key simultaneously for minimum 5 seconds. The LED above the selected **TV** key flashes twice.

| Function | Buttons | Unit |
|-----------------|---------|---|
| Audio Functions | TV + 3 | Auro/AudioVision/MediaVision 3D |
| | TV + 4 | Mediacenter |
| | TV + 5 | Loewe TV |
| | TV + 6 | Loewe TV with sound projector without system connection |

Setting the remote control for other Loewe devices

You can operate various Loewe devices with the remote control. The device keys **STB** – **VIDEO** – **AUDIO** can be reassigned to operate different Loewe devices.

STB ■ Press the required device key and the **STOP key** simultaneously for 5 sec. until the corresponding LED display flashes twice.

Then enter the two-digit device code from the list below. The corresponding LED indicator light flashes twice.

| Unit | Code | Factory setting |
|-------------------------------------|-----------|-----------------|
| Loewe ViewVision 8106 H | 10 | |
| Loewe Viewvision, Centros 21x2 | 12 | |
| Loewe ViewVision DR+ DVB-T | 13 | |
| Loewe Auro 2216 PS/8116 DT | 14 | |
| Loewe BluTech Vision Interactive | 15 | |
| Loewe Sound Projector | 17 | |
| SetTopBox (STB) data base | 18 | |
| Loewe TV - Digital radio | 19 | Audio |
| Loewe Mediacenter | 20 | |
| Loewe BluTech Vision 3D | 21 | VIDEO |
| HDMI CEC mode | 22 | |
| Loewe AudioVision | 24 | |
| Loewe Individual Sound Projector ID | 25 | |
| Apple IR codes | 26 | |
| Apple IR codes (Apple TV-2G) | 27 | STB |
| Loewe Soundbox | 28 | |
| Loewe SoundVision | 29 | |
| Loewe AirSpeaker | 30 | |
| Loewe Soundport | 31 | |
| Loewe MediaVision 3D | 35 | |
| Restore defaults | 99 | |

■ The codes shown here only apply to direct operation of the auxiliary device device.

■ The available codes may vary depending on the status of the firmware in the remote control.

■ The factory setting of the device keys can vary depending on the firmware version of the remote control

Teaching the remote control

By means of key code **18** (Set-Top Box data base) your remote control Assist may be taught for your Set-Top Box (e.g., decoder, external cable tuner). Thus, you spare yourself the use of several remote controls.

i For the use of 2-digit key codes see chapter **External devices**, section **Setting the remote control**.

The following options are available for teach-in:

- Entering a 3-digit code number
- Read-out of the programmed Set-Top Box code
- Teaching individual keys
- Delete learned codes

i In the following, the **STB** key is dealt with as an example since device code 18 is preset for this key ex-works. Code 18 may also be assigned to the **VIDEO** and **AUDIO** keys; the following description applies accordingly.

Entering a 3-digit code number

The **STB** key can be programmed directly by means of a device-dependent 3-digit code. You find a list of these codes in chapter **Code page** at the end of this instruction manual.

STB **OK** Keep the **STB** and **OK** keys depressed for five seconds. The LED above the **STB** key flashes twice.

Enter the 3-digit code from the list. The LED above the **STB** key lights up for 1 second.

OK end the programming mode. After a successful programming the LED flashes twice.

i When entering a wrong code number, the LED lights up for 2 seconds. Do this programming once again.

Read-out of the programmed Set-Top Box code

The code of the currently programmed device on the **STB** key can be indicated by the remote control.

STB **OK** Keep the **STB** and **OK** keys depressed for five seconds. The LED above the **STB** key flashes twice.

INFO Press **INFO** key.

The LED above the **STB** key shows the programmed code by flashing. The figure "0" will be indicated by flashing 5 times.

Teaching individual keys

All keys (except the **TV**, **STB**, **VIDEO** and **AUDIO** device keys as well as the **V+/-** keys **⏪** and **⏩**) can be taught for the operation of units which are not contained in the integrated data base. The functions of the selected button are then completely or partially overwritten with the new codes.

i Place the TV remote control and the remote control to be replaced in such a way that the infrared windows face each other at a distance of 1-5 cm (see sketch).

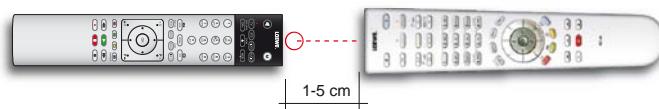

STB **Red key** Keep the **STB** and the **red key** simultaneously depressed for five seconds. The LED above the **STB** key lights up permanently.

⊙ Press key to be taught on the TV remote control.

The LED above the **STB** key flashes.

⊙ On the original remote control press the button which is to be taught.

The LED above the selected **STB** key flashes twice.

If the code is not correctly recognised, the LED above the **STB** key flashes ten times. Then repeat your entry on the original remote control. If necessary correct the allocation of the two remote controls. Continue with the other buttons as described above.

STB To end the teaching mode, press the **STB** key again.



i After 10 seconds without an entry the teaching mode is automatically terminated.

i It is possible that not all remote control codes can be taught.

i You can make a note of the functions, which you have allocated to the keys, on the notes pages at the end of this instruction manual.

Deleting individual key functions

You can delete the taught function of an individual button.

  Press **STB** and **green key** simultaneously for five seconds. The LED above the **STB** key lights up permanently.



Press key to be deleted on the TV remote control.

The LED above the **STB** key flashes twice.

Continue with the deletion of other buttons as described above.

 To end the deletion mode, press the **STB** key again.
The LED above the **STB** key flashes once.

Deleting all functions of the key for a device

You can delete all taught functions which you have set on the **STB** key.

  Press **STB** and **yellow key** simultaneously for five seconds. The LED above the **STB** key flashes twice.

Deleting all functions of the keys for all devices

You can delete all taught functions which you have set on the **TV**, **STB**, **VIDEO** or **AUDIO** buttons.



  Press **STB** and **blue key** simultaneously for five seconds. The LEDs above the keys for the devices flash twice.

| Problem | Possible cause | Remedy / Instructions |
|--|---|---|
| The TV set switches off automatically. | The automatic shutdown switches off the TV set to save energy after 4 hours of inactivity as soon as at least one signal input group is set up in the energy efficient mode Home Mode . | Using automatic shutdown is recommended for the purposes of energy saving and safety. |
| All menus are displayed in the wrong language . | The menu language was set incorrectly. | Set the menu language: Press HOME key. Call last menu item  (bottom left). Mark the fourth item from above in the following list and move to next column to the right. Call first list item with OK . Select the language and confirm it with OK . |
| General problems when connecting external devices via an AV input . | The Signal type is set incorrectly. | Set the correct signal type (System settings → Connections → AV connection settings → Signal type). If AV standard or Signal type is set to " Automatic " then this can lead to false detections with non-standard signals. In this case standard and signal must be set according to the information in the operating manual of the external device. |
| With Teletext various characters are displayed incorrectly. | The wrong character set has been set in the System settings . | Set the correct character set: System settings → Control → more ... → Standard Teletext → Character set → Standard or select the appropriate character set. |
| Errors occurred when running a CA module. | | Switch the TV set off. Remove the CA-module from the TV set. Wait a few seconds. Reinsert the CA module. Switch the TV set on again. |
| No sound via the external digital audio amplifier . | a) The external digital audio amplifier does not support the selected sound format (Dolby Digital, dts, MPEG). b) TV set and external digital audio amplifier are not connected with each other. | a) Set PCM stereo on the DVD player in the sound selection. For DVB stations switch Language/Sound b) Connect SPDIF OUT from the TV set to a digital input of the external digital audio amplifier and select the appropriate input to this. |
| A programmed recording was not made. | The provider deleted the programme from the EPG data, for example due to a programme change. The station from which the recording was made does not support automatic time control (Accurate Recording) . | Only the broadcasting organisations are responsible for transmitting data for the automatic time control . The availability of the appropriate data cannot be guaranteed. |
| There is no start or end of a programmed recording although the automatic time control (Accurate Recording) was used. | The transmission time of the program was delayed and the channel from which the recording was made has not updated the data. | Only the broadcasting organisations are responsible for transmitting data for the automatic time control . The availability of the appropriate data cannot be guaranteed. |
| No IP address will be issued to your TV set in spite of automatic IP configuration. | No DHCP server is working on your network. | Set up a DHCP server. Assign the IP addresses for the TV set manually . |

| Problem | Possible cause | Remedy / Instructions |
|--|--|--|
| Despite video or music file being played back, no sound can be heard. | a) The TV set is set to mute or the volume has been turned down too much. b) An audio device that does not exist or that is not connected, is registered under System settings → Connections → Sound components (e.g., HiFi/AV amplifier). | a) Increase the volume by pressing the V+ key on the remote control for a longer time. This will also cancel any mute setting. b) Connect the audio device and switch it on. In the Sound components wizard change back to TV speakers . |
| A media file that is displayed can not be played back. | The format of the file is not supported (see also limitations in chapter Technical data , section Media – File formats supported). | No remedy. |
| Characters received in the WLAN code of the wireless router cannot be entered for the network configuration at the TV set. | The device does not support all special characters. | Change the WLAN key of the router. |
| When searching for wireless routers, no device is found. | The router is not ready for wireless communication. | Check your wireless router. Try to make the connection again a few minutes later. |

Technical data

Changes of technical data and design of the equipment reserved.

| Loewe device type: | One 55 |  |
|--|---|--|
| Part number: | 55402W87 | |
| EU energy efficiency class: | see enclosed energy label or under www.loewe.tv/int/supportportal | |
| Screen diagonal: | 140 cm / 55 inch | |
| Power consumption On-Mode (max.) (Audio output 1/8 of the maximum value): | 190 W | |
| Power consumption On-Mode (home) ⁽¹⁾ : Annual energy consumption ⁽¹⁾ : | see enclosed energy label or under www.loewe.tv/int/supportportal | |
| Power consumption Standby Mode: Power consumption when set is switched off: | 0,38 W 0 W | |
| Resolution: | Ultra HD 3840 x 2160 px | |
| Display technology / Picture format: | LCD with Edge-LED-Backlight / 16:9 | |
| Viewing angle (horizontal / vertical): | 178° / 178° | |
| Device dimensions without stand (W x H x D): Device dimensions with stand ⁽²⁾ (W x H x D): | 123,5 x 73,7 x 4,9 cm 123,5 x 75,4 x 27,0 cm | |
| Weight without stand (approximate): Weight with stand ⁽²⁾ (approximate): | 23,7 kg 28,2 kg | |
| Ambient temperature: | 5° C – 35° C | |
| Relative humidity (non-condensing): | 20 – 80% | |
| Air pressure: | 800 – 1114 hPa (0 – 2000 m above sea level) | |
| Chassis designation: | SL 412 | |
| Power supply: | 220 V – 240 V/50–60 Hz | |
| Tuner: | terr./cable: Satellite: | VHF/Hyperband/UHF 4 levels: 13/18V/22kHz / 16 levels: DiSEqC 1.0 / single-cable system: EN 50494 |
| Range: | terr./cable: Satellite: | Terr./cable: 45 MHz up to 860 MHz Satellite: 950 MHz up to 2150 MHz |
| Station storage locations incl. AV and radio: | 6000 | |
| TV standards: | analogue: digital: | B/G, I, L, D/K, M, N DVB-T/T2, DVB-C, DVB-S/S2 (UHD via DVB to max. 60 Hz) ⁽³⁾ |
| Colour standards: | SECAM, PAL, NTSC, NTSC-V, PAL-V (60 Hz) | |
| Sound formats: | analogue (FM): analogue (NICAM): digital (MPEG): | Mono, Stereo, Dual channel Mono, Stereo, Dual channel Mono, Stereo, Dual channel, PCM, Dolby Digital, Dolby Digital Plus, Dolby Digital Pulse, Dolby MS11 |
| Audio output power (sine / music): | 2 x 10W / 2 x 20W | |
| Acoustic speaker concept: | backfiring sound, open speaker system | |
| Teletext: | TOP / FLOF / HiText (Level 2.5) | |
| Page memory: | 2000 | |
| LAN: | Standards supported: | 10 Mbit/sec Ethernet (10Base-T) / 100 Mbit/sec Fast Ethernet (100Base-T) |
| WLAN: | Standards supported: Frequency range used: Types of encoding that are supported: | IEEE 802.11a/b/g/n, 802.11ac 2400-2483,5 MHz and 5150-5725 MHz WEP 64 and 128 Bit (ASCII and HEX), WPA PSK, WPA2 AES |
| Home networking standard: | Universal Plug and Play Audio / Video (UPnP AV) | |
| File formats supported ⁽⁴⁾ : | Pictures: Audio: Video: | JPEG, PNG MP3, M4A (AAC LC), WMA (without lossless), FLAC, WAV (PCM), Ogg Vorbis AVI (MPEG-1/2, XviD, AC3, MP3), WMV (WMV9, VC-1, WMA9, WMA Pro), MP4 (XviD, H.264/MPEG-4 AVC, AAC LC), MOV (H.264/MPEG-4 AVC, AAC LC), MKV (H.265/HEVC, H.264/MPEG-4 AVC, AC3), FLV (H.264/MPEG-4 AVC, H.263, MP3, AAC LC), MPG (MPEG-1, MPEG Audio), TS/PS (MPEG-2, H.264/MPEG-4 AVC, MPEG2 Audio, AC3), VOB (MPEG-2, MPEG2 Audio, AC3)  H.264/MPEG-4 AVC upto Profil High (Level 4.2) |

⁽¹⁾ The energy consumption per year is calculated on the basis of a daily four-hour operation of the TV set on 365 days. The actual energy consumption will depend on the way the TV set is used. On-Mode (home) values less than 100 W must have decimal places (,0).

⁽²⁾ Supplied mounting option: Table Stand.

⁽³⁾ Currently, a maximum of 30 Hz is possible via DVB for UHD. After a software update, which is available in the second half 2016, 60 Hz are possible via DVB for UHD.

⁽⁴⁾ For the playability of the individual formats no guarantee can be given.

Signals via AV (PC IN) / HDMI

The following table shows the compatible signals which may be represented by your TV set using the appropriate adapter at the **AV** connection (**PC IN**) or at the HDMI connections (**HDMI1, HDMI2, HDMI3, HDMI 4 UHD**).

Set the output signal on your device so that it matches one of the signals in the table.

■ Please note that not all signals may be represented at every HDMI socket or at AV (PC IN).

| Format | Horizontal x Vertical | Frame frequency | Connection |
|---------|-----------------------|-----------------|-----------------|
| 480p60 | 720 x 480p | 60Hz | HDMI 1-4 |
| 576p50 | 720 x 576p | 50Hz | PC IN, HDMI 1-4 |
| 720p50 | 1280 x 720p | 50Hz | PC IN, HDMI 1-4 |
| 720p60 | 1280 x 720p | 60Hz | HDMI 1-4 |
| 1080i50 | 1920 x 1080i | 50Hz | PC IN, HDMI 1-4 |
| 1080i60 | 1920 x 1080i | 60Hz | HDMI 1-4 |
| 1080p24 | 1920 x 1080p | 24Hz | PC IN, HDMI 1-4 |
| 1080p25 | 1920 x 1080p | 25Hz | PC IN, HDMI 1-4 |
| 1080p30 | 1920 x 1080p | 30Hz | PC IN, HDMI 1-4 |
| 1080p50 | 1920 x 1080p | 50Hz | PC IN, HDMI 1-4 |
| 1080p60 | 1920 x 1080p | 60Hz | HDMI 1-4 |
| VGA | 640 x 480 | 60Hz | HDMI 1-4 |
| | 3840 x 2160p | 24Hz | HDMI 1-4 |
| | 3840 x 2160p | 25Hz | HDMI 1-4 |
| | 3840 x 2160p | 30Hz | HDMI 1-4 |
| | 3840 x 2160p | 50Hz | HDMI 1-4 |
| | 3840 x 2160p | 60Hz | HDMI 1-4 |

Signal input groups

In your TV set the signals are sorted in various signal input groups according to their source. In addition to the source, the type of signal is also distinguished.

For each signal input group, there are individual values for the picture settings.

| Signal group name | Signal source/Signal type |
|-------------------|--|
| SD Analog | cable analogue, interfaces AV, AVS, PC IN [†] (SD) |
| SD Digital | DVB (SD), DR+ (SD), MPEG-Encoder |
| SD Media Player | full screen display of SD videos via USB, Network, VOD and media centre (incl. HbbTV media centre) |
| SD HDMI | Playback of SD video via HDMI, e.g., DVD player |
| HD Analog | PC IN [†] (HD) |
| HD Digital | DVB (HD), DR+ (HD) |
| HD Media Player | full screen display of HD videos via USB, Network, VOD and media centre (incl. HbbTV media centre) |
| HD HDMI | Playback of HD videos via HDMI, e.g., Blu-Ray player |
| Photo Player | Playback of Photos via USB and network |
| Browser | Display of Web sites in the Browser (incl. Media apps) |
| VGA | PC IN [†] (PC) or HDMI (PC) |

[†] with VGA adaptor on AV connection.

Accessories

The following accessories are obtainable from your Loewe dealer.

Mounting options:

A variety of options for mounting your TV set on the floor, table, and wall are available.

An overview of the available placement options can be found in the chapter **accessories**, section **placement options**.

Loewe sound systems:

You can combine your TV set with Loewe sound components. Several possible combinations of speakers and subwoofers are available.

Loewe Blu-ray player:

With the Loewe Blu-ray player BluTech Vision 3D you're fully kitted out to watch Blu-ray discs with 2D and 3D material. With the Loewe system integration you control BluTech Vision 3D and your Loewe TV set simultaneously using the Assist remote control.

Loewe Assist Easy:

The reduced focused design of Loewe Assist Easy remote control guarantees survey at first sight, nevertheless all important functions are controllable with one hand. Therefore it is the optimal control centre of the new user interface Loewe Assist Media. As a multifunctional remote control it is able to control further Loewe products in addition.

Loewe Vesa adaptor bolts M6x32 (part. no. 90473988):

Mounting a Loewe flatscreen TV set to a holder according to the VESA standard **necessarily** requires the use of Loewe Vesa adaptor bolts to prevent damage to the TV set.

See chapter **Accessories**, section **VESA standard** for further information.

Upgrade kits / conversion kits / cables

USB extension (part no. 70167080):

To ensure the accessibility of the USB connections or to be able to insert USB sticks with a large housing, a USB extension can be connected to the TV set. You can purchase the USB extension via your Loewe dealer.

Adapter Micro-AV / 25cm / Scart (part no. 72150080) set of 3:

The Loewe scart adaptor allows you to extend your TV set by adding an AV socket to connect, e.g., DVD players or DVD recorders.

Adapter Micro-AV / 25cm / VGA (part no. 72155080) set of 3:

The **VGA** adaptor enables the connection of a PC monitor or a Set-top box.

Additionally to the video inputs, the adaptor for VGA is equipped with a 3.5 mm stereo jack socket for analogue sound.

Feature Upgrade Drive SL3xx (Art. no. 72341080):

By means of the feature upgrade drive you can expand the functionality of your Loewe TV set. After any necessary software updates and plugging in the feature upgrade drive, the new features are available.

DR+ Feature Disk (Art. no. 72462W00):

Like the Feature Upgrade Drive SL3xx the DR+ Feature Disk also expands the functionality of your Loewe TV set. After any necessary software updates and plugging in the DR+ Feature Disk, the new features are available.

The DR+ Feature Disk represents a recording medium for your TV set. Just quickly record and view your desired TV programmes, of course, whenever you want it.

| | |
|---|-------------|
| ■ | One 55 |
| | User manual |
| | Accessories |
| | |

Mounting options



Wall Mount Slim/Vesa Size 400

One 55: 71361T20



Wall Mount WM 67

One 55: 72115W80



Wall Mount Isoflex 32-55

One 55: 71363B00⁽²⁾



Table Stand

One 55: included in delivery



Floor Stand Universal 32-55

One 55: 72190B00⁽¹⁾



Screen Lift Plus

One 55: 65486B10⁽²⁾



Loewe Rack TS

Different versions, sizes and colours available to match Loewe TV, sound system and equipment

⁽¹⁾ Only in conjunction with appropriate adaptor to be ordered separately.

⁽²⁾ Only in conjunction with VESA Size 400 adapter.

VESA standard

Instructions on using third-party mounting options according to the VESA standard

Loewe flat screen TV sets are specified for Loewe accessories. When using third-party mounting options according to the VESA standard, the manufacturer's instructions on the mounting options must be observed.

Loewe accepts no liability for the use of mounting options from other manufacturers.

On the rear wall of the TV set, there are four points of screw connections to receive the VESA adapter bolts.

Mounting a Loewe flat screen TV set to a holder according to the VESA standard **necessarily** requires the use of Loewe VESA adaptor bolts. Otherwise, the TV set may be damaged.

The existing screws in the four screwing points must be removed.

In case of device type One 55, **the** washers under the screws must be **definitely** reused for the Loewe VESA adaptor bolts.

Screw the Loewe VESA adapter bolts (in case of One 55, **with** washers) with a torque of approx. 4 Nm into the screwing points of the TV rear panel (see Fig. 1).

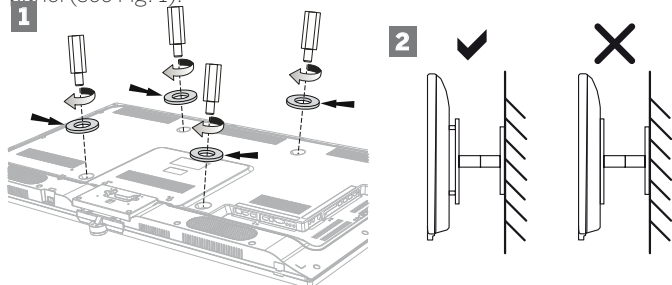

The Loewe VESA adaptor bolts are used to ensure stability and the necessary minimum distance of 5 mm between rear wall of the TV set and VESA holder (see Fig. 2). The VESA holder must not rest on the rear panel.

When mounting the TV set, always check that all **four** Loewe VESA adaptor bolts are used. For each mounting point, only **one** VESA adaptor bolt may be used. It is inadmissible to screw several VESA adaptor bolts or extend individual adapter bolts.

Measure the hole distance between the screwing points of your TV set. A hole distance of 400 x 400 mm on the rear of the TV set means VESA 400 standard.

Thus, a suitable mount bracket must also correspond to the VESA 400 standard. If the VESA standard of your TV set fits the standard of the desired bracket, the bracket has also to be approved for the weight and size of the TV set (for weight and TV set size refer to chapter **Technical Data**).

Loewe is **not** responsible for the permissible load-carrying capacity and the professional fixing of the holder.

Please observe additionally and definitely the points described in the chapter on safety instructions.

If you use a Vesa mounting options from other manufacturers, you can order the Vesa adapter bolts M6x32 (No. 90473.988) at your authorized dealer of Loewe.

Environmental protection

Power consumption

Your TV set is equipped with an eco-standby power supply. In the standby mode, the power consumption drops to low power (see chapter **Technical data**). If you want to save even more energy then switch the device off with the mains switch. Please also note that the EPG data (Electronic Programme Guide) is lost under certain circumstances and possibly programmed timer recordings **cannot** be carried out by the TV set.

i The TV set will be completely separated from mains only when you unplug the mains cable.

The power consumed by the TV set during operation depends on the energy efficiency preset in the initial installation or on the setting in the system settings.

If the TV set is not operated for 4 hours (adjustment of volume, programme change, etc.) the TV set will automatically switch to standby mode to save energy. A prompt to terminate this shutdown process appears one minute before expiry of the 4 hours.

Cardboard box and packaging

You have made a decision to purchase a high-quality technical product with a long service life. For disposal of the packaging, we have paid a fee to a commissioned recycler to pick up the packaging from the dealer in accordance with national legislation.

The device



The EU directive 2002/96/EG regulates the proper way to recycle, handle and utilise used electronic devices. **Old electronic appliances** must therefore be disposed of separately. **Never** dispose of this device in normal **domestic waste!**

You can hand in your old unit free of charge at identified collection points or to your dealer if you buy a similar new unit. Other details about re-acceptance (also for non-EU countries) are available from your local municipal administration.

Batteries



The batteries supplied as initial equipment do not contain any pollutants such as cadmium, lead, or mercury.

In accordance with the Battery Directive, used batteries should **no** longer be disposed of in the **domestic waste**. Dispose of your batteries at no charge in the **collection containers** which are set up for this purpose in retail stores.

Licences

Manufactured under licence from Dolby Laboratories. "Dolby" and the double-D symbol are trademarks of Dolby Laboratories.

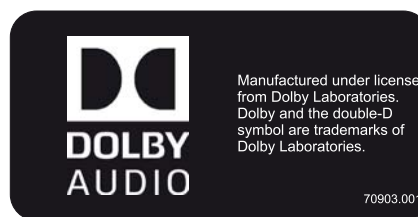

This set contains a software which is partly based on the work of the Independent JPEG Group.

This product includes software developed by the OpenSSL Project for use in the OpenSSL Toolkit (<http://www.openssl.org/>).

This software is provided by the OpenSSL project "as is" and any expressed or implied warranties, including, but not limited to, the implied warranties of merchantability and fitness for a particular purpose are disclaimed. In no event shall the OpenSSL project or its contributors be liable for any direct, indirect, incidental, special, exemplary, or consequential damages (including, but not limited to, procurement of substitute goods or services; loss of use, data, or profits; or business interruption) however caused and on any theory of liability, whether in contract, strict liability, or tort (including negligence or otherwise) arising in any way out of the use of this software, even if advised of the possibility of such damage.

This product includes cryptographic software written by Eric Young (eyay@cryptsoft.com).

This product includes software written by Tim Hudson (tjh@cryptsoft.com).

This product contains software which was developed by third parties and / or software which is subject to GNU General Public License (GPL) and/or GNU Lesser General Public License (LGPL). You can pass on and modify them in accordance with Version 2 of the GNU General Public License or optionally every later version which is published by the Free Software Foundation.

The publication of this programme by Loewe is carried out WITHOUT ANY GUARANTEE OR SUPPORT, particularly without an implicit guarantee concerning MARKET MATURITY or the USABILITY FOR A SPECIFIC PURPOSE. Details can be found in the GNU General Public License. You can obtain the software via the Loewe customer service department.

The GNU General Public License can be downloaded from: <http://www.gnu.org/licenses/>.

CA module error codes

In case of problems with a CA module, error codes are displayed by TV set. The following table from the CI specification shows the meaning of the error codes.

| Error Code + | Error condition | Error detected by | Host action | CI Plus Module action | Comments |
|--------------|----------------------------------|-------------------|---|--|--|
| 00 | | N/A | None | None | |
| 01 | | CICAM | | CICAM goes to pass - through mode ¹ . | |
| 02 | | CICAM | | - CICAM goes to pass-through mode ¹ . - a revocation notification message is displayed. | |
| 03 | | CICAM/Host | | - If EMI>0 CICAM goes to pass-through mode, otherwise switches to DVB CI mode - a response error notification message is displayed. | The service operator and CAS may choose under what conditions to descramble when operating in DVB CI mode. |
| 04 | | CICAM/Host | | - If EMI>0 CICAM goes to pass-through mode, otherwise switches to DVB CI mode - a response error notification message is displayed. | The service operator and CAS may choose under what conditions to descramble when operating in DVB CI mode. |
| 05 | | CICAM | None | Recommended: - CICAM retries the download 2 times - a response error notification message is displayed. | |
| 06 | | CICAM | None | Recommended: - CICAM retries the download 2 times - a response error notification message is displayed. | |
| 07 | | CICAM | None | Recommended: - CICAM retries the download 2 times - a response error notification message is displayed. | |
| 08 | | CICAM | None | CICAM goes to pass - through mode | |
| 09 | | CICAM/Host | Host stops the CICAM. | CICAM goes to pass - through mode | |
| 10 | | CICAM/Host | Host stops the CICAM. | CICAM goes to pass - through mode | |
| 11 | | CICAM/Host | Host stops the CICAM. | CICAM goes to pass - through mode | |
| 12 | | CICAM/Host | Host stops the CICAM. | CICAM goes to pass - through mode | |
| 13 | | Host | Host stops the CICAM. | None | |
| 14 | | Host | Host goes to DVB-CI mode ² . | None | |
| 15 | | Host | Host stops the CICAM. | None | |
| 16 | | CICAM | None | - CICAM goes to pass- through mode - a response error notification message is displayed. | |
| 17 | | CICAM | None | - CICAM goes to DVB-CI mode ³ - a response error notification message is displayed. | |
| 18 | | CICAM | None | - CICAM goes to pass- through mode - a response error notification message is displayed. | |
| 19 | | CICAM | None | - CICAM goes to DVB-CI mode ³ - a response error notification message is displayed. | |
| 20 | | CICAM | None | - CICAM goes to DVB-CI mode ³ - a response error notification message is displayed. | |
| 21 | | CICAM | None | - CICAM goes to DVB-CI mode ³ - a response error notification message is displayed. | |
| 22 | CICAM Requires Update | CICAM | None | - CICAM goes to pass- through mode - a response error notification message is displayed. | |
| 23-127 | Reserved for CI Plus | CICAM | None | - a response error notification message is displayed. | |
| 128-255 | Private Use for Service Operator | CICAM | None | - a response error notification message is displayed. | |

¹ The CICAM relays the transport stream unaltered and does not descramble any services (CI Plus or DVB).

² The Host behaves like a DVB - CI compliant Host.

³ The CICAM descrambles only services that require no CI Plus protection (DVB-CI fallback mode).

0-9

24p motion picture display: Movies released on Blu-ray Disc support the 24p motion picture display. The Blu-ray player transfers the original film format to the television with 24 frames per second. The DMM (DigitalMovieMode) set in the factory calculates and inserts additional intermediate pictures, which suppress film jerking typical for the cinema, thereby providing for a smooth motion sequence.

A

Administrator: Person who administers the network, i.e. takes care of setting up and maintaining all components belonging to the network.

Active antenna: An antenna with its own power supply or amplification which can improve the reception in areas with a poor coverage.

ARC: Abbreviation for **Audio Return Channel**.

Audio Return Channel: The audio return channel which was introduced with the **HDMI** Standard 1.4 is used when an audio system with audio (pre) amplifier, e.g. Loewe MediaVision 3D, is connected to a TV set via HDMI. The digital audio signal of the TV set (e.g. the sound of the current TV program) can be transferred to the audio amplifier via the audio return channel of the HDMI cable. Thus the same cable which is normally responsible for transferring image data from a connected media player to the TV set transfers the audio data in the opposite direction. In this way, the audio return channel makes the cinch cable, which has previously been required in addition to the HDMI cable, redundant.

Automatic time control: Also called **Accurate Recording**. Similar to **VPS** for analogue stations the automatic time control monitors the start and end times of programmes from DVB stations. If these times deviate from the data programmed in the timer data, the running time of the recording is adapted automatically. The automatic time control is not supported by all DVB stations.

AV socket: Socket for audio and video signals.

AV sources: Audio/Video source.

AVI: Abbreviation for Audio Video Interleave, a video container file format developed by Microsoft. A single AVI video file can contain several audio, video and text data streams (thus the name container format).

B

Band: Name for a transmission range.

Blu-ray Disc: The follow-up format of **DVD**. The contents of about five DVDs fit onto one Blu-ray Disc (abbreviated BD). Therefore, the Blu-ray disc provides enough space for high-resolution images and multi-channel sound formats.

BMP: Abbreviation for Bitmap, a grid graphics format designed for Microsoft Windows and OS/2 that is wide spread and therefore supported by almost every popular graphics software package without any problems.

C

CA Module: The **Conditional Access module** contains the coding system and compares the transmitted code with the one on the **Smart Card**. If they match, the appropriate stations or programmes are decoded.

CEC: Abbreviation for Consumer Electronics Control. CEC provides universal component control functions for entertainment electronics devices (e.g. System standby, One Touch Play). CEC is referred to by Loewe as **Digital Link HD**.

Channel (WLAN): Devices that want to communicate with each other have to use the same WiFi channel. In Europe the WiFi frequency band is currently divided into 13 channels.

Cinch cable: Cable for transmitting sound or pictures.

CI slot: See **Common Interface**.

Client: Also called network client, describes an end device such as your TV set that is connected to the network and gets data from a (media) server to make it accessible to the user.

Common Interface: The Common Interface (CI slot) is a standardised interface. By inserting suitable decoding modules (**CA modules**) and a **Smart Card** coded digital programmes can be used.

Common Interface Plus: CI Plus is an advancement of the **Common Interface** standard. CI Plus slots are in principle downward compatible to the previous CI standard, i.e. CA modules and Smart Cards according to the past CI standard can continue to be used in CI Plus slots, as far as the programme provider permits this. Additionally, extended regulations apply however to CI Plus.

Component: See **Component connection**.

Component connection: Also referred to as **Component**. Connection where the video signal is transferred via three separate (Cinch) connections. It comprises the brightness signal **Y** as well as the colour difference signals **Pb** (blue component) and **Pr** (red component).

Conditional Access module: See **CA module**.

D

DHCP: Abbreviation for Dynamic Host Configuration Protocol. DHCP allows automatic assignment of IP addresses with the aid of a DHCP server.

DHCP server: Network service which takes care of automatic assignment of **IP addresses** to clients.

Digital Link HD: System for controlling units via the HDMI connection of the Loewe TV set when they have been set up in a covered position.

DMM: Abbreviation for Digital Movie Mode. Whether a studio recording, live broadcast, or feature film – the broadcast images are always displayed optimally. Still images are reproduced in all their sharpness and tranquillity. By creating intermediate images, DMM enables perfect studio quality, even with quick movements.

DNC: Abbreviation for "Digital Noise Control". Weak TV signals (analogue) can generate disruptive picture noise. DNC adjusts the effect of digital noise reduction to the picture contents.

DNS: Abbreviation for Domain Name System. Readable names (e.g. www.loewe-int.de) are assigned to numerical **IP addresses**. DNS servers are responsible for the resolution of readable addresses into the corresponding IP addresses.

DRM: Digital Rights Management. Processes to control copyright protected data. To be used correctly, DRM protected contents require not only a DRM capable device but also the possession of a license issued by the provider (to be paid for).

DTS: Digital Theatre Systems; Digital multi-channel audio.

DVB-C/-S/-T: Digital Video Broadcasting stands for digital television. Technical DVB is the standardised process for transmitting digital content (television, radio, multi-channel audio, room sound, **EPG**, Teletext, and other supplemental services) through digital technology. **CST** for terrestrial or antenna distribution.

DVD: Abbreviation for Digital Video Disc and later Digital Versatile Disc.

DVD receiver: Combi device of DVD player and radio without integrated amplifier.

Dynamic contrast ratio: Here the light intensity of the display is adapted in case of a high black content in the picture. The so-called backlights are dimmed automatically and the contrast ratio increases temporarily, i.e. dynamically.

E

Electronic Programme Guide: See **EPG**.

EPG: Electronic Programme Guide is the electronic variant of a printed TV guide. Using the EPG you can watch the TV programme of the TV station, transfer the appropriate data. The list of programmes contains the title, beginning and end and duration of the programme. In addition brief descriptions of the content of the programmes are also displayed.

Ethernet: Cable linked data net technology for local networks (LANs). Also covers standards for e.g. plug connectors and transfer speeds.

Euro AV socket: Interface for connecting video devices to a TV set. This socket is also referred to as Scart socket.

Exif: Standard format for additional data with modern digital cameras, e.g. date and time, aperture, light sensitivity, alignment of the camera (portrait/landscape).

F

FLOF: Full Level One Facilities. Teletext system in which names and numbers of the jump destinations are transmitted in the bottom line on every page. This guides the reader to related topics for example. An information about which pages exist and which pages have sub-pages is not available in FLOF.

G

Gateway: Transition to another network; in this case connection from the home network to the Internet. The network device that establishes this connection is normally used as a standard gateway. As a rule, the DSL router also represents the Internet gateway.

H

HbbTV: HbbTV (Hybrid broadcast broadband television) is an industry standard that offers an open platform for technology that is not dependent on manufacturers. HbbTV combines TV programmes with online services seamlessly over broadband Internet (DSL).

HDCP: High-bandwidth Digital Content Protection. Coding system provided for the **DVI** and **HDMI** interfaces for secure transmission of audio and video data.

HDMI: High Definition Multimedia Interface, represents a newly developed interface for the fully digital transfer of audio and video data.

HD Ready: A quality seal that is awarded to products that are capable of displaying high-definition television (**HDTV**).

HDTV (HD): High Definition Television is a collective term, designating a series of high-resolution television standards.

High and low band: Transmission ranges for satellites.

Host: Computer that the server services are provided from, i.e. that makes data available. Refer also to media server.

I

ID3 tags: Additional information for MP3 and WMA audio files. Information about the singer, title, album and album cover can be saved here among other things. This data is then processed by the PC using an ID3 tag editor.

IP address: IP addresses (Internet Protocol Addresses) are used to identify devices in an Internet Protocol (IP) network. IP addresses are made up of four groups of numbers of three digits each.

IR-Link: The IR Link function allows the operation of accessory devices with concealed installation made by other manufacturers via the Loewe TV set. The infrared sensor required for this is available as an accessory and can be connected to the IR-Link connection of the TV set.

J

JPEG/JPG: Joint Photographic Experts Group is a committee, which has developed a standardised method for the compression of digital images. This method JPEG (**JPG** for short), named after the committee, is a commonly used graphic format for photos.

L

LAN: Abbreviation for Local Area Network. Mainly used as a name for networks with cabling (Ethernet).

LCD: Liquid Crystal Display.

LCN: Logical Channel Numbers. In stations with LCN, the channel location number belonging to the station is also transmitted by the provider. The stations are sorted according to these channel location numbers.

LNB/LNC: The crucial electronic component of a satellite antenna is referred to as an LNB (Low Noise Block Converter). It is mounted in the focal point of a parabolic antenna. The designation **LNC** (Low Noise Converter) indicates that conversion to a lower intermediate frequency takes place. The supplemental block in the LNB refers to the fact that a whole frequency range (a block) is converted in each case.

M

MAC address: Hardware address of a network adaptor, e.g., the network card in the PC. It is issued permanently by the manufacturer and is used to uniquely identify devices in networks.

Mbit/sec: Information about the transfer rate in networks in megabits, i.e. millions of characters per second. With WLAN the maximum speed is 11 (IEEE 802.11b), 54 (IEEE 802.11g) or 300 (IEEE 802.11n) Mbit/sec, in wired networks 10 Mbit/sec or 100 Mbit/sec (Fast Ethernet).

Media Server: Stands for the device on which multimedia content is stored, but is also the name for the service provided by the device that makes this data available to the network.

Modulator: Transmitter in the video or DVD recorder so that the devices can receive signals via the tuner of the TV device.

Mono: Single channel sound.

MP3: Data format for compressed audio files.

MPEG: Digital compression method for video.

Multimedia content: Videos, music files and photos are grouped together under this term.

N

NAS: The term describes a hard disk which is independently linked to the network (i.e. without a PC).

Network ID: NID refers to the so-called programme ID number, also known as network ID – a number between 0 and 8191. This specification is necessary in specific cable networks of some countries. Then only DVB signals of this station network are searched for.

NICAM: Audio standard. Is used in Denmark, England, France, Sweden, and Spain.

NTSC: American colour standard, stands for National Television Standards Committee.

P

Page Catching: For teletext, refers to marking and calling a page number.

PAL: European colour standard, stands for phase alternation line.

PCM: Pulse Code Modulation for digital sound.

Picture in Picture: See **PIP**.

PIP: Picture in Picture; a function which displays two pictures on the screen.

Pixel: Also called picture element or pel. Denotes both the smallest unit of a digital graphic grid and its display on a screen with grid control.

Pixel error: A pixel error is a defective pixel, usually on an LCD. Pixel errors may be caused by production errors. They are expressed for example by a constantly lit pixel or a constantly black pixel. Single defective pixels however are excluded from a guarantee.

PNG: Abbreviation for Portable Network Graphics, a freely available grid graphics format for loss-free compression.

Port: It allows assignment of data packages to various services which are running on one device under the same network address.

Powerline: Powerline designates a type of wired network connection in which data is transferred via the domestic electricity network using optionally available adaptors.

P (continuation)

Progressive JPEG: **Progressive JPEGs** are built up gradually. The quality of the picture increases progressively during the loading process.

ProScan/Progressive Scan: Progressive Scan (abbr. PS) or full picture method is a technique in the picture build-up of monitors, TV sets, beamers, and other display devices in which the output device is not sent line interlaced half pictures – unlike in the interlace technique – but real full pictures.

PSK: Clients that wish to connect to a wireless network secured with PSK must know this key.

R

RGB: Colour signals Red, Green and Blue.

Router: Device for connecting several networks, e.g., home network and Internet.

S

Satellite tuner: Receiver for satellite programmes.

SDTV: Standard Definition TeleVision.

SECAM: French colour standard, stands for Séquentiel à mémoire.

Set-top box: Set-top box (STB for short) refers to a device in entertainment electronics which is connected to another device, usually a TV set, and offers the user additional functional options.

Signal input group: Depending on the applied signal, the signal sources are divided into different groups.

Signal strength: Strength of the received antenna signal.

Signal quality: Quality of the incoming antenna signal.

Smart Card: The Smart Card is an electronic chip card issued by the respective programme provider or by the certification free Pay TV operators. It contains the code which is decoded by the **CA module**.

Static contrast ratio: Describes the difference between the brightest and darkest picture display.

Stereo: Dual channel sound.

Switch: Device for connecting several computers to a network.

Switching voltage: Video devices supply this voltage to switch the TV set to playback.

Symbol rate: Specifies the transmission speed for data transmission.

T

Terrestrial: In data transmission a wireless transmission that does not use satellites as intermediate station is referred to as terrestrial.

TFT: Thin Film Transistor. One widely distributed application is control of liquid crystal flat screens, for which a signal transistor is used for each pixel. This design of display is also referred to as active matrix, however it is frequently also referred to as TFT display.

Tuner: Another term for receiver.

U

Ultra HD: Ultra HD (abbr. for Ultra High Definition) is a digital high-definition video format, which is about four times the resolution of HDTV.

USB: Universal Serial Bus. Serial bus system for connecting external devices (USB card reader, USB stick).

UPnP AV Is used to control network devices from all manufacturers. Has become a widespread standard for home networking.

V

VGA: PC interface for connecting a monitor.

W

WEP: Abbreviation for Wired Equivalent Privacy. Former standard process in the WiFi encryption, now outdated.

Wired network: see LAN.

Wireless network: see WLAN.

WLAN: Abbreviation for Wireless Local Area Network. Also abbreviated as wireless network.

WMA: Abbreviation for Windows Media Audio, Microsoft own audio data format. As with MP3 files, the content is compressed here as well.

WMV: Abbreviation for Windows Media Video, proprietary Microsoft video data format.

WPA: Abbreviation for Wi-Fi Protected Access. Replaced WEP as standard encryption for wireless networks.

Y

Ycc/Ypp: Colour standards for Set-top boxes.

YCbCr: Digital colour model, informally also incorrect designation for signals in standard resolution (**SDTV**). The YCbCr colour model, in which, e.g., DVDs are coded, has been developed from the YUV colour model used in analogue television technology. With YCbCr, the data is transferred via digital interfaces such as **DVI** or **HDMI** without being converted.

YPbPr: Analogue colour model, see also **Component connection**. The analogue YPbPr signal is generated from the YCbCr signal by a converter in the source player and then output at the 3 component outputs of the source player.

YUV: The YUV colour model is used for analogue television in accordance with the standards **PAL** and **NTSC**. YUV is often informally referred to when **YPbPr** (for analogue connections/cables) or **YCbCr** (in digital applications) is actually meant. YUV only occurs in quadrature modulation during PAL or NTSC transfer and is not otherwise used.

- BG** Този уред отговаря на основните изисквания и разширените съответни предпоставки **Директива 1999/5/ЕС**. Разрешено е използването му във всички държави от **ЕС**, и освен това в **Исландия, Норвегия и Швейцария**. Във **Франция и Италия** използването му е разрешено **само в затворени помещения**.
- CZ** Toto zařízení je v souladu se základními požadavky a ostatními odpovídajícími ustanoveními **Směrnice 1999/5/EG**. Může být používán ve všech zemích **EU** dodatečně také na **Islandu, v Norsku a ve Švýcarsku**. Ve **Francii a v Itálii** je použití přístroje dovolené **jenom v interiéru**.
- D** Dieses Gerät entspricht den grundlegenden Anforderungen und den weiteren entsprechenden Vorgaben der Richtlinie **1999/5/EG**. Es darf in allen Ländern der **EU** sowie zusätzlich in **Island, Norwegen** und der **Schweiz** betrieben werden. In **Frankreich und Italien** ist die Nutzung **nur in Innenräumen** zulässig.
- DK** Dette udstyr er i overensstemmelse med de væsentlige krav og andre relevante bestemmelser i **Direktiv 1999/5/EF**. Det må kun anvendes i **EU-landene** samt i **Island, Norge og Schweiz**. I **Frankrig og Italien** er det kun tilladt at anvende det **inden-dørs**.
- E** Este equipo cumple con los requisitos esenciales así como con otras disposiciones de la **Directiva 1999/5/CE**. Puede operar en todos los países de la **UE** y adicionalmente en **Islandia, Noruega y Suiza**. En **Francia e Italia**, su uso está permitido **únicamente en espacios interiores**.
- FIN** Tämä laite täyttää **direktiivin 1999/5/EY** olennaiset vaatimukset ja on siinä asetettujen muiden laitetta koskevien määräysten mukainen. Laitetta saa käyttää kaikissa **EU-maissa** sekä **Islannissa, Norjassa ja Sveitsissä**. **Ranskassa ja Italiassa** laitetta saa käyttää **vain sisätiloissa**.
- F** Cet appareil est conforme aux exigences essentielles et aux autres dispositions pertinentes de la **Directive 1999/5/EC**. L'utilisation est possible dans tous les pays de l'**UE**, en **Islande**, en **Norvège** et en **Suisse**. En **France** et en **Italie** l'utilisation est autorisée **uniquement dans des espaces fermés**.
- GB** This equipment is in compliance with the essential requirements and other relevant provisions of **Directive 1999/5/EC**. It may be operated in all countries in the **EU** and also in **Iceland, Norway and Switzerland**. In **France and Italy** it may only be used **indoors**.
- GR** Αυτός ο εξοπλισμός είναι σε συμμόρφωση με τις ουσιώδεις απαιτήσεις και άλλες σχετικές διατάξεις της **Οδηγίας 1999/5/ΕΚ**. Επιτρέπεται η λειτουργία της σε όλες τις χώρες της **ΕΕ**, καθώς και στην **Ισλανδία**, στην **Νορβηγία** και στην **Ελβετία**. Στην **Γαλλία** και στην **Ιταλία** επιτρέπεται η χρήση **μόνο σε εσωτερικούς χώρους**.
- I** Questo apparato è conforme ai requisiti essenziali ed agli altri principi sanciti dalla **Direttiva 1999/5/CE**. Può essere messo in funzione in tutti i paesi dell'**UE** e inoltre in **Islanda, Norvegia** e in **Svizzera**. In **Francia** e in **Italia** è consentito l'uso **solo in ambienti chiusi**.
- N** Dette utstyret er i samsvar med de grunnleggende krav og andre relevante bestemmelser i **EU-direktiv 1999/5/EF**. Det kan brukes i alle **EU-land** og dessuten i **Island, Norge og Sveits**. I **Frankrike og Italia** er **kun innendørs bruk** tillatt.
- NL** Dit apparaat voldoet aan de essentiële eisen en andere van toepassing zijnde bepalingen van de **Richtlijn 1999/5/EG**. Het gebruik is toegestaan in alle landen van de **EU** en ook in **IJsland, Noorwegen en Zweden**. In **Frankrijk en Italië** is het gebruik **slechts binnenshuis** toegestaan.
- P** Este aparelho está em conformidade com os requisitos fundamentais e todas as restantes disposições da **Diretiva 1999/5/CE**. Pode ser utilizado em todos os países da **UE** assim como na **Islândia, Noruega e Suíça**. Em **França e Itália** a sua utilização apenas é permitida em espaços interiores.
- S** Denna utrustning är i överensstämmelse med de väsentliga kraven och andra relevanta bestämmelser i **Direktiv 1999/5/EC**. Apparaten får användas i alla länder inom **EU** liksom på **Island, i Norge och i Schweiz**. I **Frankrike och Italien** får apparaten användas **endast inomhus**.

A

| | |
|---|--------------|
| Access code | 85 |
| Adding stations to personal list | 81 |
| Additional functions for DR+ archive playback | 59 |
| Adjusting the HiFi/AV amplifier | 105 |
| Adjusting the sound | 75 |
| Adjust size of the PIP image | 93 |
| Allow switching voltage | 106 |
| Antenna DVB | 72, 102, 106 |
| Antenna DVB-S | 106 |
| Antenna DVB-T | 106 |
| ARC | 116 |
| Archive recording | 44 |
| Artist Search | 66 |
| Audio commentary | 93 |
| AUDIO key | 118 |
| Audio playback | |
| Playback | 63 |
| Audio playback from external devices | 117 |
| Audio/Radio | 31, 62 |
| Audio return channel | 116 |
| Auto dimming | 72 |
| Auto dimming - Room | 73 |
| Auto format (AMD) | 73 |
| Automatic menu info | 18 |
| Automatic rotate | 67 |
| Automatic scan TV+Radio | 72, 76 |
| Automatic shutdown | 7 |
| Automatic time control | 54 |
| Auto volume | 72 |
| AV connecting settings | 72, 102, 106 |
| AV list | 35 |
| AV output signal | 72 |

B

| | |
|------------------------------|--------|
| Balance | 72, 75 |
| Batteries | 13 |
| Blu-ray player | 112 |
| Bookmarks | |
| Delete | 60 |
| Delete individual ones | 60 |
| Jump | 59 |
| Set | 44, 59 |
| Brightness | 72, 73 |
| Browser | 71 |

C

| | |
|--|-----|
| Cable fixing | 11 |
| Camcorder | 112 |
| CA modul | 110 |
| Change title of an archive recording | 47 |
| Changing the station list | 32 |
| Character table | 17 |
| CI slot | 110 |
| Cleaning and care | 7 |
| Clear data base | 84 |
| Clock display | 18 |

| | |
|---|--------|
| Code number | 85 |
| Color intensity | 72 |
| Coloured keys | 39 |
| Colour intensity | 73 |
| Colour temperature | 72, 73 |
| Common Interface Plus | 110 |
| Component connection | 115 |
| Compose / edit Personal list | 81 |
| Connecting antennas | 12 |
| Connecting HiFi/AV amplifier | 116 |
| Connecting home network | 12 |
| Connecting the speaker system (AUDIO OUT) | 116 |
| Connecting the TV set | 12 |
| Connections | 10, 72 |
| Contrast | 72, 73 |
| Control | 72 |
| Create new personal list | 81 |
| Crossover | 67 |

D

| | |
|---|--------------|
| Data capture | 84 |
| Deblocking filter | 72, 73 |
| Delete | |
| Bookmarks | 60 |
| individual bookmarks | 60 |
| Recording | 47 |
| Delete manager | |
| Set delete protection for timer recording | 54 |
| Delete personal list | 81 |
| Deleting blocks | 80 |
| Deleting stations from the personal list | 81 |
| Devices on AV | 114 |
| Digital Link | 72, 102, 107 |
| Digital Link HD | 113 |
| Digital Link HD functionality | 107 |
| Digital Noise Control (DNC) | 72, 73 |
| Direct recording | 44 |
| DR+ | 72, 94 |
| DR+ archive | 46 |
| DR+ Streaming | 50, 72 |
| Notify started „Follow me" recording | 95 |
| DR+ Streaming settings | 94 |
| Also use other archives | 95 |
| DR+ device group name | 95 |
| DR+ device name | 95 |
| IP port number | 95 |
| DVB character set | 93 |
| DVB settings | 72, 93 |
| DVD player | 112 |

E

| | |
|------------------------------|------------|
| Edit new personal list | 81 |
| Edit personal list | 81 |
| Energy efficiency | 19, 72, 86 |
| Environment | 128 |

| | |
|------------------------------|---------|
| EPG | 36, 72 |
| Explanation of keys | 18 |
| Explanation of symbols | 18 |
| Export archive entries | 48 |
| Export log file | 72, 97 |
| Extras | 72, 108 |

F

| | |
|--------------------------------------|--------|
| Favourites | 31 |
| Film quality improvement (DMM) | 72, 73 |
| FLOF | 39 |
| Follow-Me function | 50, 56 |
| Function list | 35 |
| Function of the TEXT key | 96 |

G

| | |
|---|--------------|
| Game console | 107, 112 |
| Gaming mode | 72, 102, 107 |
| Gamma brightness correction | 73 |
| General information on menu operation | 15 |

H

| | |
|------------------------|------------|
| Hard disks | 72, 96 |
| Formatting | 96 |
| HbbTV | 41, 72, 96 |
| HbbTV-Modus | 96 |
| HbbTV text | 41 |
| HDMI | 112 |
| HDMI CEC | 113 |
| Headphone volume | 35 |
| History | 33 |
| Home | 31 |
| Home view | 31 |

I

| | |
|--------------------------------------|--------------|
| Image+ Active | 72, 73 |
| Initial installation wizard | 19 |
| Installing the TV set | 12 |
| Instant Channel Zapping | 32 |
| Instant recording | 44 |
| Integrated features | 72, 108, 109 |
| Interval functions | 60 |
| Deleting part of the recording | 61 |
| Hide | 60 |

J

| | |
|----------------------------|----|
| Jump | 57 |
| Jump distance | 94 |
| Jumping to Bookmarks | 59 |

L

| | |
|-------------------------|-----------------|
| Language | 19, 72, 84, 121 |
| Licence agreement | 19 |
| LNC/LNB | 24, 26, 27 |
| Loudness | 72, 75 |

M

| | |
|---|---------|
| Mains switch | 9, 14 |
| Manual scan TV | 76 |
| Manuell scan (incl. antenna status) | 72 |
| Maximum switch on volume | 72 |
| Maximum volume | 72, 75 |
| MediaNet | 69 |
| Browse | 70 |
| Exit | 69 |
| Settings | 70 |
| Mobile phone keyboard | 17 |
| Move block | 80 |
| Move picture up/down | 72, 73 |
| Move stations in the personal list | 81 |
| Moving of archive entries | 48 |
| Multimedia / Network | 72 |
| Multimedia settings | 72, 101 |
| Multi select | 47 |
| Music playback | |
| end | 64 |
| Repeat | 64 |
| Shuffle playback | 64 |
| Winding | 63 |

N

| | |
|------------------------------|--------|
| Networking | 98 |
| Network selection | 21, 22 |
| Network settings | 72, 98 |
| Notify hidden sections | 94 |
| Numerical keys | 15, 32 |

O

| | |
|---------------------------|--------|
| One touch recording | 44 |
| On/Off button | 9 |
| On-screen displays | 72, 92 |

P

| | |
|-------------------------------|------------|
| Page selection | 39 |
| Parental lock | 49, 72, 85 |
| PC | 114 |
| PC IN - Display | 73 |
| Permanent clock display | 18 |
| Personal list | 33 |
| Add station | 81 |
| Create new list | 81 |
| Delete list | 81 |
| Delete station | 81 |
| Move station | 81 |
| Rename list | 81 |
| Photo | 31, 67 |
| Exit | 68 |
| Full-screen mode | 68 |
| Rotate photo | 68 |
| Slide show | 68 |
| Picture | 72 |
| Picture adjustment | 72, 73, 74 |

P

| | |
|--|------------|
| Picture format | 72, 73, 74 |
| 4:3 | 74 |
| 16:9 | 74 |
| PALplus | 74 |
| Panorama | 74 |
| Zoom | 74 |
| Picture settings | 73 |
| PIP | 42, 72 |
| PIP Settings | 93 |
| Positioning/aligning the DVB-T antenna | 106 |
| Post-record time | 94 |
| Pre-record time | 94 |
| Proxy server | 98, 100 |

Q

| | |
|------------------|--------|
| Quick start mode | 72, 86 |
|------------------|--------|

R

| | |
|------------------------------------|--------------|
| Radio mode | 65, 66 |
| Record conflict | 52 |
| Recording | 94 |
| Remote control | 8, 13, 118 |
| Remote TV switch on of the TV set | 107 |
| Renaming the HDMI port designation | 112 |
| Renaming the personal list | 81 |
| Renderer | 72, 101 |
| Repeat initial installation | 19, 72, 108 |
| Reset to factory settings | 72, 108, 109 |
| Restore stations | 80 |

S

| | |
|---|---------------------|
| Safety | 6, 7, 11 |
| Satellite selection | 24, 25, 26, 27 |
| Satellite system | 23 |
| Scope of delivery | 5 |
| Scrambled stations | 21, 22, 28, 77, 111 |
| Search for artists | 66 |
| Selecting a station out of the station list | 32 |
| Select station | 32 |
| using the numerical keys | 32 |
| via personal lists | 33 |
| with P+/P- | 32 |
| Serial recording tolerance | 94 |
| Service | 138 |
| Setting the volume | 32 |
| Set-top box | 112 |
| Sharpness | 72, 73 |
| Shutdown of the ext. device via TV button | 107 |
| Signal type | 106 |
| Skin tone | 72, 73 |
| Slide show speed | 67 |
| Smart Card | 110 |
| Smart jump | 57, 94 |
| Software | 72 |
| Software download | 87 |

Software update

| | |
|---|-------------------|
| Automatic update via the internet | 91 |
| Manually via Antenna | 89 |
| Via Antenna | 90 |
| Via USB memory medium | 88 |
| Sound | 72, 75 |
| Sound adjustment | 72, 75 |
| Sound components | 72, 102, 103, 116 |
| Sound picture synchronisation | 72 |
| Sources | 31 |
| Standard Teletext | 72 |
| Standby mode | 14 |
| Start behaviour of HbbTV-stations | 96 |
| Station lists Radio | 72, 76, 80 |
| Station lists TV | 72, 76, 80 |
| Stations | 72, 76 |
| Station search | 66 |
| Status display | 34 |
| STB key | 118 |
| Stop recording early | 45 |
| Subtitle | 45, 61, 93, 94 |
| Supply voltage 5V | 106 |
| Switching off the TV set during recording | 45 |
| Switch off | 14 |
| Switch on | 14 |
| Switch-on volume | 75 |
| Switch to live picture | 43 |
| System settings | 31, 72 |

T

| | |
|----------------------------|---------|
| Teletext | 39 |
| Time and date | 72, 92 |
| Time display | 18 |
| Timer | 51 |
| Timer list | 51 |
| Timer Services | 54 |
| Timer data | 53 |
| Automatic time control | 54 |
| Beginning | 53 |
| Date | 53 |
| Delete protection | 54 |
| End | 53 |
| Favourite | 54 |
| Folder | 53 |
| Lock recording | 54 |
| Recording subtitles | 54 |
| Recording type | 53 |
| Station | 53 |
| Timer Services | 51 |
| Time shift | 43 |
| TOP | 39 |
| Transfer all station lists | 72, 76 |
| TV | 31, 32 |
| TV key | 13, 118 |
| TV on when memorised | 84 |
| TV viewing with time shift | 43, 44 |

U

Update station list automatically 72, 76
UPnP 12
USB stick 87

V

Value-added service 8, 41
VBD+ 73
VESA standard 127
Video 31, 55
VIDEO key 118
Video playback
 Change picture format 59
 Jump by entering a time 57
 Playback 56
 Repeat 58
 Selecting language/sound 59
 Winding 58
Viewing a locked movie 49
Viewing another movie from the archive during archive recording 44
Volume adjustment 72

W

Wake on LAN/WiFi 98
Watching other stations during archive recording 44
Web 31, 69
WEB key function 72, 97

Y

YPbPr 115
YUV 115

AUS

Qualifi Pty Ltd
24 Lionel Road
Mt.Waverley VIC 3149 Australia
Tel +61-03-8542 1111
Fax +61-03-9543 3677
E-mail: info@qualifi.com.au

B NL L

Loewe Opta Benelux NV/SA
Uilenbaan 84
2160 Wommelgem, België
Tel +32 - 3 - 2 70 99 30
Fax +32 - 3 - 2 71 01 08
E-mail: ccc@loewe.be

CH

Telion AG
Rütistrasse 26
8952 Schlieren, Schweiz
Tel +41 - 44 732 15 11
Fax +41 - 44 732 15 02
E-mail: infoKD@telion.ch

CN

Guangdong MG Audio Development Co.Ltd
No.8 Jinghu Rd. Xinhua St. Huadu Reg.
GZ, PRC
Tel +86-(0)20-22675666
Fax +86-(0)20-22675777
E-mail: service@loewe-mg.com

Xiamen Tenote Investment Co. Ltd
26F 3# Xinglin Bay Operation Center,
No.478 xinglinwan Avenue,
Jimei District, Xiamen, Fujian, PRC
Tel +86-400 088 1566
E-mail: service@loewe-tnt.com

CY

Hadjikyriakos & Sons Ltd.
121 Prodromos Str., P.O Box 21587
1511 Nicosia, Cyprus
Tel +357 - 22 87 21 11
Fax +357 - 22 66 33 91
E-mail: savvas@hadjikyriakos.com.cy

CZ

BaSys CS s.r.o.
Sodomkova 1478/8
10200 Praha 10 - Hostivar,
Česká republika
Tel +420 234 706 700
Fax +420 234 706 701
E-mail: office@basys.cz

D A

Loewe Technologies GmbH,
Customer Care Center
Industriestraße 11
96317 Kronach, Deutschland
Tel +49 9261 99-500
Fax +49 9261 99-515
E-mail: ccc@loewe.de

DK

EET Europarts
Loewe Denmark
Bregnerødvej 133 D
3460 Birkerød, Denmark
Tel +45 - 82 19 19
E-mail: info@eeteuroparts.dk

E

Gaplasa S.A.
Conde de Torroja, 25
28022 Madrid, España
Tel +34 - 917 48 29 60
Fax +34 - 913 29 16 75
E-mail: loewe@maygap.com

F

Loewe France SAS
Rue du Dépôt,
13 Parc de l'Europe, BP 10010
67014 Strasbourg Cédex, France
Tel +33 - 3 - 88 79 72 50
Fax +33 - 3 - 88 79 72 59
E-mail: loewe.france@loewe-fr.com

FIN

EET Europarts
Loewe Finland
Metsänneidonkuja 12
02130 Espoo, Finland
Tel +358 9 47 850 900
www.eeteuroparts.fi

GB IRL

Loewe UK Limited
1st Floor, 237A Kensington High St
London
W8 6SA, UK
Tel +44 - (0) 207 368 1100
Fax +44 - (0) 207 368 1101
E-mail: enquiries@loewe-uk.com

GR RO AL

Issagogiki Emboriki Ellados S.A.
321 Mesogion Av.
152 31 Chalandri-Athens, Hellas
Tel +30 - 210 672 12 00
Fax +30 - 210 674 02 04
E-mail: christina_argyropoulou@
isembel.gr

HR

Plug&Play Ltd.
Bednjanska 8, 10000 Zagreb
Hrvatska (Kroatia)
Tel +385 1 4929 683
Fax +385 1 4929 682
E-mail: info@loewe.hr

I

Loewe Italiana S.r.L.
Via Monte Baldo, 14/P - 14/N
37069 Dossobuono di Villafranca di
Verona
Tel +39 - 045 82 51 690
Fax +39 - 045 82 51 622
E-mail: info@loewe.it

IL

Clear electronic entertainment Ltd
13 Noah Mozes St.
Agish Ravad Building
Tel Aviv 67442, Israel
Tel +972 - 3 - 6091100
Fax +972 - 3 - 6092200
E-mail: info@loewe.co.il

IND

Nonplus Ultra Home Automation Pvt Ltd
First Floor, No. 615, Second Main Road
Indiranagar Stage I, Indiranagar
Bangalore 560038
India
Tel +91 80 41114599
E-mail: jimmy@nplusultra.in

IR

Pars Royal Taramesh
LOEWE Gallery
#3 Shariati St. Opp. Soheil St.
P.O.Box 1914965537
Tehran, Iran
Tel + 98 21-22391661
E-Mail: info@tarameshgroup.com

JOR

ACCU-TECH Solutions Co.
1-Kharija Al-Ashja'i Street
Jabal Al-Weibdeh
P.O.Box 9668 Amman 11191, Jordan
Tel: +962-6-465-9985
Fax: +962-6-465-0119
E-Mail: info@accutech-solutions.net

KSA

LOEWE Show Room
Olaya Street, Near Kingdom Center
RIYADH, SAUDI ARABIA
P.O.Box 92831 Riyadh 11663
Tel +966-11-4640927
Fax +966-11-4640759
E-mail: hkkurkjian@gmail.com

LV EST

Kpartners, SIA
A. Caka iela 80
Riga, LV-1011, Latvia
Tel +3 71 - 67 29 29 59
Fax +3 71 - 67 31 05 68
E-mail: evgenii.bebnev@loewe.lv

LT

A Cappella Ltd.
Ausros Vartu 5, Pasazo skg.
01129 Vilnius, Lithuania
Tel +370 - 52 12 22 96
Fax +370 - 52 62 66 81
E-mail: info@loewe.lt

N

EET Europarts AS
Olaf Helsetsvai 6 (Vekstsenteret)
0694 Oslo, Norge
Tel +47 - 22919500
E-mail: salg@eeteuroparts.no

P

Gaplasa S.A.
Rua Professor Henrique de Barros
Edifício Sagres, 2º. C
2685-338 Prior Velho, Portugal
Tel +351 - 21 942 78 30
Fax +351 - 21 940 00 78
E-mail: geral.loewe@mayro.pt

PL

3LOGIC Sp.z o.o.
ul. Zakopiańska 153
30-435 Kraków
Tel +48 - 12 640 20 00
Fax +48 - 12 640 20 01
www.3logic.pl

RI

V2 Indonesia
5th Intiland tower
Jl. Jenderal Sudirman 32
Jakarta 10220, INDONESIA
Tel +62-21 57853547
E-mail: service@v2indonesia.com

RL

I Control SAL
Gemmaizeh, Rmeil.
Building 328 1st Floor Beirut, Lebanon
Tel +961 1 446777 / 1 587446
Fax +961 1 582446
E-mail: info@icontrol-leb.com

RUS

Service Center Loewe
Aptekarsky per.4 podjezd 5A
105005 Moscow, Russia
Tel +7 - 499 940 42 32 (ext. 454)
Fax +7 - 495 730 78 01
E-mail: service@loewe-cis.ru

S

EET Europarts AB
Loewe Sweden
Box 4124
SE-131 04, Nacka, Sverige
Tel +46 - 8 507 510 00
E-mail: Kundservice@eeteuroparts.se

SGP

Atlas Care Centre
11 changi south street 3
#03-01 builders centre
Singapore 486122
Tel +65 - 6745 2028
Fax +65 - 6546 7861
E-mail: service@atlas-sv.com

TR

ENKAY GROUP
SERVISPLUS MUSTERI HIZMETLERI
Alemdag Cad. Site Yolu No:18
Umraniye, Istanbul, TÜRKIYE
Tel 444 4 784
E-mail: info@servisplus.com.tr

ZA

Volco Enterprise Close Corporation
Unit 8
7 on Mastiff (Road)
Longlake Ext 1, Lingbro Business Park
2165 Johannesburg
Tel +27 11 608 1228
Fax +27 11 608 1740
E-mail: v63@mweb.co.za

| | | | | | | | |
|--------------------------|---|------------------|--|---------------------|---|------------------|--|
| STB | | | | | | | |
| ABSAT | 166, 169 | CONDOR | 164, 226 | GENX | 317 | LORENZEN | 161, 162, 163, 164, 165, 186 |
| AEGIR | 179 | CONNEXIONS | 047, 096, 226, 231 | GENIX | 024 | LORRAINE | 193 |
| AIWA | 141 | CONRAD | 006, 010, 164, 169, 226, 230 | GENERAL-INSTRUMENTS | 332 | LUPUS | 226 |
| AKAI | 033, 104 | CONTEC | 054, 135, 169 | GIUCAR RECORD | 089 | LUXOR | 006, 010, 021, 088, 097, 099, 120, 123, 130, 214 |
| ALBA | 060, 017, 067, 104, 111, 126, 180, 201 | COSAT | 059 | GMI | 175 | LYONNAISE | 110 |
| ALCATEL | 336 | CROWN | 175 | GOLDBOX | 128, 191, 211 | M&B1 | 197 |
| ALDES | 133, 168, 179, 201 | CRYPTOVISION | 067, 315 | GOODMANS | 067, 111 | MACAB | 225, 232, 248, 329 |
| ALLSAT | 033, 048, 059, 077, 201 | CYBERMAXX | 116 | GRAETZ | 088, 099 | MAGAI | 080 |
| ALLSONIC | 133, 168, 226 | CYRUS | 037 | GRANADA | 021, 099 | MANATA | 060, 171, 172 |
| ALLTECH | 060, 137, 225 | DAERYUNG | 047 | GRANDIN | 185, 239 | MANHATTAN | 042, 059, 067, 106, 111, 151, 171, 172, 179, 210, 221 |
| ALPHA | 033 | DAEWOO | 060, 017, 025 | GROTHUSEN | 017, 193 | MARANTZ | 033, 037 |
| ALTAI | 047 | DANSAT | 048, 077 | GRUNDIG | 026, 003, 067, 090, 097, 171, 172, 176, 217, 227, 240, 241, 242, 020, 307, 316 | MASCOM | 081 |
| AMITRONICA | 060 | DAUMLING | 163 | HANSEATIC | 197 | MASPRO | 060, 026, 003, 093, 096, 106, 108, 113, 137, 161, 176, 242 |
| AMPERE | 047, 186, 207 | D-BOX | 045, 214 | HANTOR | 017, 094 | MASTER_S | 135 |
| AMSTRAD | 060, 006, 047, 071, 097, 132, 165, 174, 175, 186, 212, 216, 217, 227, 228 | DECCA | 038 | HANURI | 179 | MATSUI | 003, 109, 171, 172, 176 |
| ANGLO | 060 | DECSAT | 310 | HARTING UND HELLING | 133 | MAX | 164 |
| ANKARO | 060, 051, 133, 161, 162, 168, 226 | DECSAT CANAL | 310 | HASE & IGEL | 161 | MB | 197 |
| ANTTRON | 017, 077, 180 | DELFA | 212 | HELIOCOM | 164 | MEDIABOX | 191, 211 |
| APOLLO | 017 | DEUTSCHE TELEKOM | 056 | HIGH PERFORMANCE | 085, 122 | MEDIAMARKT | 175 |
| ARCON | 025, 051, 079, 132, 136, 161 | DEW | 025, 054 | HINARI | 017, 077 | MEDIASAT | 006, 128, 191, 211, 223 |
| ARMSTRONG | 033, 175 | DIAMOND | 225 | HIRSCHMANCE | 090 | MEDION | 060, 226 |
| ARTHUR MARTIN | 130 | DIRECTV | 144 | HIRSCHMANN | 006, 009, 010, 047, 081, 113, 133, 171, 172, 176, 196, 203, 216, 219, 243 | MEDISON | 060 |
| ASA | 009 | DISCOVERER | 197 | HISAWA | 094 | MEGA | 033 |
| ASAT | 025, 033 | DISEQC | 171, 172 | HITACHI | 067, 106, 111, 120 | MELETRONIC | 204 |
| ASLF | 060 | DISK EXPRESS | 051 | HNE | 165 | MEMPHIS | 054, 134 |
| AST | 127, 194 | DISMOND | 225 | HOUSTON | 059, 071, 161, 162, 171 | METRONIC | 060, 017, 117, 119, 121, 131, 146, 147, 149, 151, 152, 153, 154, 156, 157, 168, 175, 179, 180, 185, 204, 217 |
| ASTACOM | 171, 172 | DISTRATEL | 119, 146, 147, 149, 185, 217 | HUMAX | 212, 236, 244, 005 | METZ | 090, 176 |
| ASTON | 032, 095 | DISTRISAT | 033, 059 | HUTH | 013, 054, 059, 094, 133, 136, 161, 162, 163, 164, 168, 169, 175, 186 | MICRO | 164, 180 |
| ASTRA | 013, 021, 025, 098, 099, 164, 175, 178, 190, 222, 223 | DNR | 161 | HYPERVERSION | 345 | MICRO ELECTRONIC | 060 |
| ASTRO | 006, 091, 094, 176, 177, 179, 180, 181 | DNT | 033, 037, 047, 231 | ICX | 138 | MICRO MAXX | 116 |
| AUDIOTON | 059, 180 | DRAKE | 029 | IKUSI ALLSAT | 136 | MICRO STAR | 116 |
| AUSTAR | 212, 332 | DST | 017 | IMEX | 185 | MICRO TEC | 060 |
| AVALON | 047 | DUAL | 025 | IMPERIAL | 126 | MICRO TECHNOLOGY | 060, 190, 223 |
| AXIS | 054, 210, 223, 226 | DUNE | 226 | INGELEN | 088, 099 | MICRONIK | 249 |
| BARCOM | 021, 051 | DYNASAT | 196 | INNOVATION | 116 | MINERVA | 003, 090 |
| BEKO | 067 | ECHOSTAR | 060, 021, 047, 086, 088, 128, 211, 213 | INTERNATIONAL | 186 | MITSUBISHI | 067, 090 |
| BEST | 051, 226 | EIF | 014, 198 | INTERTRONIC | 175 | MITSUMI | 222 |
| BIRMINGHAM CABLE | 343 | EINHELL | 060, 006, 017, 097, 163, 168, 169, 175, 186, 222 | INTERVISION | 042, 059, 164, 170 | MNET | 320, 321, 342 |
| BLAUPUNKT | 090, 176 | ELEKTA | 179 | ITALTEL | 213 | MORGAN | 060, 033, 059, 132, 163, 169, 175, 186, 199, 207, 222, 250 |
| BLUE SKY | 060, 217 | ELSAT | 071 | ITT | 021, 067, 088, 099, 120, 123 | MOVIE TIME | 328 |
| BOCA | 163, 169, 175, 186, 199, 207, 222 | ELTA | 017, 033, 059, 226 | ITT NOKIA | 009, 010, 021, 067, 088, 099, 120, 123, 214 | MR ZAPP | 329 |
| BRAIN WAVE | 094, 161 | EMMASAT | 059 | JEEMON | 059 | MULTICHOICE | 100, 235 |
| BRANDT | 069 | EMME ESSE | 133, 213, 226 | JERROLD | 138, 330, 332, 341, 343 | MULTISTAR | 080 |
| BRITISH SKY BROADCASTING | 050, 227 | ENGEL | 060 | JOHANSSON | 059, 094 | MURATTO | 127, 193 |
| BRITISH TELECOM | 341 | EP SAT | 067 | JOK | 171, 172, 200, 229 | MYRYAD | 037 |
| BROADCAST | 013 | EURIEULT | 185, 217 | JSR | 059 | MYSAT | 060 |
| BROCO | 060, 223 | EUROCRYPT | 021, 067 | JVC | 003, 104 | NAVEX | 094 |
| BRUNS | 133 | EURODEC | 110, 232 | KABELVISION | 330 | NEC | 030, 073 |
| BSKYB | 227 | EUROPA | 006, 033, 161, 162, 164, 169, 212 | KAMM | 060, 215 | NEIRU | 079 |
| BT | 104, 171, 172, 229, 335 | EUTRA | 137, 203 | KATHREIN | 060, 033, 037, 080, 081, 090, 091, 094, 096, 112, 114, 135, 166, 176, 180, 196, 204, 218, 245, 246 | NETA P | 140 |
| BT SATELLITE | 171 | EXATOR | 017, 104, 180 | KEY WEST | 163 | NETWORK | 077 |
| BUBU SAT | 060 | FAGOR | 059 | KOLON | 017 | NEUHAUS | 060, 006, 059, 161, 162, 164, 169, 210, 223, |
| BUSH | 048, 077, 106, 126 | FERGUSON | 023, 048, 067, 077, 106, 108, 111, 124, 206 | KONIG | 164 | NEUSAT | 060, 161, 210 |
| BVV | 161 | FIDELITY | 006, 071, 097 | KOSCOM | 210 | NEXTWAVE | 138 |
| CABLETIME | 308, 311, 312, 333, 334 | FILMNET | 318 | KOSMOS | 080, 081, 133, 193 | NIKKA | 060, 175, 201 |
| CAMBRIDGE | 006, 104, 199 | FINLANDIA | 021, 067 | KR | 059, 137, 180, 203 | NOKIA | 009, 010, 021, 045, 067, 088, 099, 105, 120, 123, 211, 214, 242, 251, 346 |
| CANAL | 019 | FINLUX | 009, 010, 021, 067, 220 | KREISELMEYER | 176 | NOMEX | 221 |
| CANAL DIGITAL | 128 | FINNSAT | 110 | K-SAT | 060 | NOOS | 329 |
| CANAL PLUS | 128, 019, 320, 321 | FLAIR MATE | 060 | KYOSTAR | 017, 180 | NORCO | 221 |
| CANAL SATELLITE | 128, 191, 211 | FORCE | 068 | KYOTO GMI ATLAN | 143 | NORDMENDE | 017, 067, 179, 206 |
| CANARY | 137 | FOXTEL | 235, 022, 319 | LAGS ELECTRONIC | 226 | NOVIS | 094 |
| CARAT.SOM | 054 | FRACARRO | 017, 087, 196, 213 | LASAT | 054, 164, 175, 179, 186, 199, 222, 226 | NSC | 328 |
| CHAPARRAL | 012, 134 | FRANCE TELECOM | 344 | LEMOM | 161, 162, 247 | NTC | 133, 203 |
| CHESS | 197 | FREECOM | 017, 193, 201 | LENCO | 060, 017, 025, 079, 161, 162, 164, 193, 221, 223, 226 | NTL CABLETELL | 332 |
| CITYCOM | 135, 164, 203, 204, 230 | FREESAT | 137 | LENNOX | 042, 059 | OCEANIC | 225 |
| CLARK | 180 | FTE | 060, 080, 136, 137, 169, 196, 199, 212, 226 | LENSON | 006 | OCTAGON | 017, 025, 054, 161, 162, 180 |
| CLATRONIC | 094 | FUBA | 010, 014, 017, 021, 047, 051, 088, 135, 176, 220, 226 | LEXUS | 033 | OKANO | 080, 133, 175 |
| CLEMENS KAMPHUS | 133, 210 | G SAT | 077, 130 | LEYCO | 104 | OLYMPIC | 133 |
| CLYDE CABLE VISION | 317 | GALAXI | 051 | LG (GOLDSTAR) | 079, 107, 193 | ONDIGITAL | 187, 188, 189 |
| CNT | 179 | GALAXIS | 054, 059, 133, 161, 168, 209, 210, 211, 212, 223, 226, 236, 237, 238 | LIFESAT | 197, 226 | ONO | 301 |
| COMCAST | 004 | GALAXISAT | 127 | LIFETEX | 116 | OPTEX | 059, 135, 196, 208 |
| COMCRYPT | 320, 321 | GARDINER | 204 | LOKIA | 088 | | |
| COMMANDER | 161, 162 | | | | | | |
| COMM LINK | 168 | | | | | | |
| COMMUNICADO | 054 | | | | | | |
| COMTEC | 054, 168 | | | | | | |

| | | | | |
|--------------------------|--|--------------------|---|---|
| OPTIMA | 133 | SATMASTER | 013 | 191, 205, 206, 211 |
| OPTUS | 332 | SATPARTNER | 017, 079, 094, 133, 179, 180, 193, 201 | THORENS 225 |
| ORBIT | 025, 194 | SATSTATION | 151 | THORN 067 |
| ORBITECH | 006, 017, 103, 169, 181, 224 | SAVA | 077, 108, 161, 164, 171, 172, 179, 200, 201, 206, 217 | THORN-FERGUSON 023, 048, 067 |
| ORIGO | 126, 221 | SCHACKE | 180 | TIOKO 135, 175 |
| OSAT | 097 | SCHAUB LORENZ | 088, 099 | TLEWIRE 059 |
| OTTO VERSAND | 090 | SCHNEIDER | 171, 172, 218 | TOKAI 033 |
| OXFORD | 104 | SCHWAIGER | 077, 114, 135, 161, 164, 169, 197, 217, 255 | TONNA 060, 006, 013, 059, 067, 171, 210 |
| P ACE | 001, 022, 044, 048, 050, 067, 077, 098, 108, 124, 189, 202, 227, 242, 252, 253, 319, 347 | SCIENTIFIC ATLANTA | 305, 306, 325, 326 | TOPFIELD 011 |
| PACIFIC | 225 | SEDEA-ELECTRONIQUE | 017 | TORX 341 |
| PACKSAT | 171, 172 | SEEMANN | 047, 104, 175, 223 | TOSHIBA 067, 145 |
| PALCOM | 092 | SEG | 017, 094, 165, 178, 190, 197, 226 | TPS 129, 205 |
| PALLADIUM | 003, 006, 017, 175 | SELECO | 059, 213 | TRENDLINE 222 |
| PALSAT | 006 | SEPTIMO | 146, 151, 154 | TRENDPLAIN 222 |
| PANASAT | 235, 254 | SERVI SAT | 059 | TRGRA 088 |
| PANASONIC | 031, 067, 124, 227 | SIEMENS | 090, 176, 199 | TRIAD 085, 101, 127, 193, 194 |
| PANDA | 021, 048, 067, 164, 176, 210 | SILVA | 079, 193 | TRIASAT 006, 220 |
| PATRIOT | 104 | SINTRACK | 013 | TRIAx 060, 006, 033, 047, 211, 220, 230 |
| PHILIPS | 026, 003, 033, 037, 051, 067, 077, 124, 128, 144, 156, 161, 162, 169, 171, 172, 176, 180, 187, 188, 191, 204, 211, 218, 229, 242, 313, 323, 329, 345 | SKANTIN | 060 | TRISTAR 025 |
| PHOENIX | 054, 077 | SKARDIN | 223 | TUDI 327 |
| PHONOTREND | 042, 059, 133, 142, 168, 212 | SKINSAT | 006 | TWINNER 115, 119 |
| PIONEER | 128, 191, 211, 302 | SKR | 060 | U NIDEN 058, 071, 080, 148, 208 |
| PIXX | 255 | SKY | 034, 050, 189, 227, 001 | UNISAT 033, 054, 175 |
| PLANET | 126, 213 | SKY MASTER | 060, 133, 168, 170, 197, 215 | UNITED CABLE 330, 341 |
| POLSAT | 110 | SKY PLUS | 002 | UNITOR 051, 094 |
| POLYTRON | 047, 135 | SKYLAB | 051 | UNIVERSUM 003, 009, 071, 164, 165, 176 |
| PREDKI | 017, 094 | SKYMAX | 033 | V AIADIGITAL 078 |
| PREISNER | 047, 103, 163, 169, 175, 186, 199, 222 | SKYSAT | 197 | VARIOSAT 176 |
| PREMIER | 059, 133 | SKYVISION | 059 | VARIOSAT 176 |
| PREMIERE | 191, 211, 214, 007 | SL | 161, 165, 175, 186 | VECTOR 178 |
| PROMAX | 067 | SM ELECTRONIC | 060 | VENTANA 033, 037 |
| PROSAT | 168, 170 | SMART | 186 | VESTEL 165 |
| PROSONIC | 165 | SONY | 067, 211, 227 | VIASAT 016 |
| PROTEK | 225 | SR | 222 | VIDEOCRYPT 023 |
| PROVISAT | 201 | STARLAND | 060 | VIDEOTRON 331 |
| PROVISION | 179 | STARRING | 094 | VIDEOWAY 331 |
| PVP STEREO VISUAL | 330 | STARSAT | 080 | VIDIO WAY 015 |
| PVP STEREO VISUAL MATRIX | 341 | STRONG | 017, 025, 179, 180, 186, 196, 211, 226, 235 | VIPER 054 |
| PYE | 003 | STS | 328 | VIRGIN MEDIA 063 |
| PYXIS | 208, 210 | STV | 014 | VISIOPASS 309, 313, 329 |
| Q UADRAL | 168, 169, 170, 171, 172, 173, 226 | STVI | 014, 137 | VISIOSAT 060, 194, 200 |
| QUELLE | 090, 097, 164, 165 | SUMIDA | 175 | VIVA 161, 162 |
| QUIERO | 110 | SUNNY SOUND | 226 | VORTEC 017, 082, 083, 132, 142 |
| R ADIOLA | 033, 037 | SUNSAT | 060, 223 | VTECH 127, 194, 200, 204 |
| RADIX | 047, 137, 216 | SUNSTAR | 163, 175, 186, 222, 226 | W ELA 060, 163, 169, 186 |
| RAINBOW | 137, 180 | SUPERCABLE | 343 | WESTMINSTER 335 |
| RC | 138 | SUPERNOVA | 189 | WETEKOM 006, 197, 207 |
| RC-1000 | 104 | T AGRA | 059 | WEWA 067 |
| RED STAR | 226 | TANDBERG | 008 | WIBO 175 |
| REDPOINT | 223 | TANDY | 085, 122 | WINERSAT 094 |
| REDSTAR | 226 | TANTEC | 067, 108 | WINTERGARTEN 168 |
| RFT | 033, 037, 161, 162, 168, 224 | TATUNG | 067 | WISI 006, 047, 067, 088, 123, 127, 164, 169, 176, 194, 200, 210 |
| ROADSTAR | 060 | TCM | 116 | WITTENBERG 071 |
| ROVER | 060, 170 | TECHNILAND | 013, 059 | WOLSEY 085, 122 |
| S ABA | 077, 108, 161, 164, 171, 172, 179, 200, 201, 206, 217, 229 | TECHNISAT | 006, 028, 033, 047, 102, 103, 181, 184, 224, 231 | WOORISAT 179 |
| SABRE | 067 | TECHNOWELT | 164 | WORLD 094 |
| SAGEM | 205, 329 | TECO | 025, 175, 222 | WORLDSAT 171, 172 |
| SAKURA | 054, 057 | TELASAT | 164, 197 | X COM 169 |
| SALORA | 021, 088, 099, 120, 130, 303 | TELECIEL | 180, 201 | XCOM MULTIMEDIA 046 |
| SAMSUNG | 017, 080, 127, 132, 211, 243, 302, 324 | TELECOM | 060 | XRYPTON 226 |
| SAT | 006, 071, 127, 194 | TELEDIREKT | 077 | XSAT 060, 046, 166, 169 |
| SAT PARTNER | 017, 094, 133, 179, 180, 193, 201 | TELEFUNKEN | 017, 083, 171, 172 | Y ES 189 |
| SAT TEAM | 060 | TELEKA | 026, 006, 047, 081, 103, 180, 161, 164, 175, 203, 210 | Z AUNKONIG 161 |
| SATBOX | 304 | TELEMASTER | 179 | ZEHNDER 051, 080, 114, 127, 135, 165, 179, 204, 226, 255 |
| SATCOM | 013, 164, 197 | TELEMAX | 018 | ZENITH 034, 314 |
| SATEC | 060, 077, 242 | TELEPIU | 320, 321 | ZETA-TECHNOLOGY 033 |
| SATECO | 017 | TELE PLUS ONE | 320, 321 | ZODIAC 180 |
| SATELCO | 226 | TELESAT | 164, 197 | ZWERGNASE 163, 175 |
| SATFORD | 013 | TELESERVICE | 311, 314 | |
| SATLINE | 170 | TELESTAR | 006 | |
| | | TELETECH | 215 | |
| | | TELEVES | 006, 067 | |
| | | TELEWIRE | 059 | |
| | | TENSAI | 025, 094 | |
| | | TEVION | 116 | |
| | | THOMSON | 060, 049, 067, 128, 155, 164, 171, 172, | |

LOEWE.