Equipment

Blu-ray Player

BluTechVision 3D



35688021



Instructions for use

LOEWE.

Table of Contents.....	2	Control	19
WELCOME!.....	3	Playing discs.....	19
Set of equipment supplied.....	3	Playback in general.....	20
About this operating manual.....	3	Disc playback.....	21
General information on the operation of the set.....	3	Disc Menu.....	23
Performance.....	3	Picture Mode.....	23
Legal information.....	3	3D Setting.....	23
For your safety.....	4	BD-LIVE™.....	23
Environmental protection.....	5	Main Menu.....	24
Quick guide.....	6	Video files.....	24
Remote control.....	7	Music files.....	25
Control elements / Connections	8	USB Mode.....	25
Connection.....	9	Importing Audio CDs.....	25
BluTechVision 3D cable.....	9	Photo files.....	26
Preparing the remote control unit.....	10	Setting the HDMI resolution.....	26
Activate/deactivate.....	10	YouTube videos.....	27
Digital Link HD.....	10	Troubleshooting	28
Start-up.....	10	Glossary	29
Main Menu.....	11	Language Code Page / Area Code Page.....	30
Language Menu.....	11	Technical Data	31
Settings Menu.....	11	Trademarks	32
Display Menu.....	12	Service.....	33
Audio Menu.....	13		
Lock Menu.....	14		
Network Menu.....	15		
Others Menu.....	17		
Updating software	18		

Thank you

for choosing a Loewe product.

Loewe stands for the highest standards of technology, design and user friendliness. This applies equally for TV, DVD, video, audio and accessories. Neither technology nor design is an end in itself, but both are intended to provide our customers with the best possible audio and visual experience. Our design is not influenced by short-term, fashionable trends. You have, after all, purchased a high-quality piece of equipment which you do not want to tire of tomorrow or the day after.

Set of equipment supplied

- BluTechVision 3D
- HDMI cable
- Mains cable
- These instructions for use

About this operating manual

The information in these instructions refers to the Loewe product **BluTechVision 3D** (Art No. 53504 L/T/U).

Unless stated otherwise, the instructions refer to the operating elements on the **Assist** remote control (Art. no. 89900A13)

I For best results regarding safety and the longevity of the set, we recommend you read the chapter "**For your Safety**" before switching it on for the first time (see page 4).

Paragraphs which begin with the symbol **I** indicate important instructions, tips or conditions for the following settings.

Terms which you will find in the menus or printed on the remote control or unit are written in **bold** type.

The necessary control elements are shown in the descriptions to the left of the text containing the instructions for action.

Depending on the connected accessory equipment, the menus in the unit can differ from those described here.

All the photos, music titles, albums and album covers in this operating manual are only meant to serve as examples.

General information on the operation of the set

For further information on the user interface and the general operation of your Set see page 11.

Performance

The **Loewe BluTechVision 3D** offers you convenient access to your media collection. It plays Blu-ray Discs™ in 2D/3D format, audio CDs and video DVDs. You can also play digital video, photo and music files from a USB stick and from your home network. A special feature of this device is that it can play YouTube videos from the internet.

Connection options

USB 2.0
HDMI (HDMI output, V1.4)
AUDIO OUT (Analog audio output stereo L/R)
SPDIF OUT (Digital audio output)
LAN (Network connection)

Blu-ray™/CD/DVD Player

Playing Blu-ray™ 2D and 3D discs
Playing audio CDs, CD-R and CD-RW discs
Playing DVD video, DVD-ROM and DVD-RW discs
DVD upscaling (720p/1080p/4k - UltraHD)
Control via drive buttons on the unit as well as via the **Assist** remote control

Media management

DLNA streaming client
BD/DVD/CD/File Title recognition via Internet databases
Display of album graphics (only MP3)
Importing audio CDs to USB storage devices

Music playback

Playing MP3 or WMA audio files
Repeating titles, tracks or directories
Random playback

Video playback

Playing DivX(HD) video files
Displaying subtitle
Playback of YouTube videos from the Internet

Photo display

Display of JPEG photo files
Slide show with music

Use with other Loewe system components

Connection of Loewe flat TV sets via Digital Link HD (HDMI CEC) and operation of both devices with a single **Assist** remote control - also for concealed set-up of the **BluTechVision 3D**.

Legal information

Loewe Technologies GmbH
Industriestraße 11
D-96317 Kronach
www.loewe.de

Editorial date 11/15-CH/TB
© Loewe Technologies GmbH,
Kronach
BD.5.05.261.D

All rights including translation, technical modifications and errors reserved.

For your safety, and to avoid unnecessary damage to your unit, please read and follow the safety advice below:

Intended Use and ambient conditions

This Set is intended exclusively for rendering video and audio signals and is designed for use in residential apartments or office premises. It must not be used in rooms with a high level of **humidity** (e.g. bathroom, sauna) or a high **dust concentration** (e.g. workshops). The manufacturer's warranty is only valid for use in the specified permissible environment.

If the unit is used outdoors, make sure that it is protected from **moisture** (rain, dripping water and splashing water or dew). High humidity and dust concentrations lead to leakage currents in the device. This can result in a shock hazard by touching it or even fire.

If you have moved the unit out of the **cold** into a warm environment, leave it switched off for about an hour because of a possible formation of **condensation**.

Do not place **objects** containing **liquids** on top of the unit. Protect the device against dripping and splashing water.

Candles or **naked flames** must be kept away from the unit at all times to prevent it from catching fire.

Never place the Set in a location where it is exposed to **vibrations**. This can lead to material overload.



Power supply:

Incorrect voltages can damage the unit. This device may only be connected to a power supply with the voltage and frequency indicated on the type plate using the supplied mains cable. The **mains plug** of the unit must be easily accessible so that the device can be disconnected from the mains at any time. When unplugging the unit from the mains, pull at the connector body and not at the **cable**. The cables in the mains plug could otherwise be damaged and could cause a **short-circuit** when plugged in again.

Lay the **mains cable** so that it cannot be damaged. The power cable may not be kinked or laid over sharp edges, stood on or exposed to **chemicals**; the latter also applies to the unit as a whole. A power cable with damaged insulation can cause **electric shocks** and poses a **fire risk**.

Air circulation and high temperatures

Ensure that there is at least 3 cm free space on the sides and above the set for air circulation, if the set is placed in a **cabinet** or on a **shelf** or is hung up.

Like any electronic device, your unit requires **air for cooling**. Obstruction of the air circulation can cause fires.

Prevent **metal items**, needles, paper clips, liquids, wax, or similar items, from getting into the interior of the device through the **vent slots** in the rear panel. Such objects can cause **short circuits** in the unit, which could possibly cause a fire.

If something should get into the **interior of the set** then immediately unplug the mains plug of the device and contact the **field service** for more information.

Set-up

Place the unit on an **even, firm, horizontal surface**. Particularly ensure that the set does not protrude to the front when placed in or on pieces of furniture.

Set up the device where it is not exposed to direct **sunlight** and where it is not exposed to additional heating by **radiators**.

The picture and sound of a TV set, a player or a radio in the vicinity can be distorted. If this is the case, do not place the unit in the direct vicinity of these devices.

Set up the device so that the infrared signal of the remote control can reach the display of the player without hindrance (or if this is not possible, see "Digital Link HD (HDMI CEC)" page 10).

Do not place any strong artificial light source in front of the unit. This could have a detrimental effect on the infrared reception.

Watching TV using the 3D function

Read the following safety instructions before using the 3D function of your device.

Please only use the Loewe 3D devices with the Loewe 3D glasses that can be purchased as an accessory from your Loewe dealer.

People with a visual disorder may not be able to perceive 3D effects or may only be able to perceive them to a limited extent. People who are sensitive to flickering images (e.g. those with epilepsy) should only use this function after having consulted their doctor.

It might take some time for you to get used to the 3D glasses and before you can perceive the 3D effects properly. Stop using the 3D devices immediately if you experience any feelings of nausea, dizziness or malaise when viewing 3D content.

Supervise children whilst they are viewing 3D content, as they can be particularly sensitive to it.

Allow more time for a break after having watched 3D movies, so that you are able to relax. Failure to do so could result in headaches, fatigue, dizziness or malaise.

Position yourself comfortably in front of the 3D TV set and ensure that you are seated firmly. By doing this, you will avoid any injuries that may occur due to reacting to extreme 3D content.

Switch off any artificial light sources (e.g. energy saving lamp) between the 3D TV set and the 3D glasses. These could impair the infrared reception or the TV picture may flicker as a result.

Supervision

Do not allow **children** to use the device without supervision or to play in the immediate vicinity of the device. The device could tip over, be pushed off or pulled down from the stand surface and injure someone.

Do **not** allow the switched-on device to run **unattended**.

Volume

Loud music can lead to ear damage. Avoid extreme volume especially over long periods and when using headphones.

Thunder storms

In the event of a thunderstorm, pull out the **mains plug** and all connected **antenna cables** from the device. Overvoltage caused by **lightning strokes** can damage the device via the antenna system, as well as via the mains. The mains plug and all connected antenna cables should also be pulled out during long periods of **absence**.

Cleaning and care

i Switch off the device prior to cleaning.

Clean the device and the remote control unit with a soft, moist, clean and colour-neutral cloth only, **without any aggressive or scouring cleaning agents**.

Repairs and accessories



Warning: to rule out the danger of an electric shock, do not remove the cover. There are no parts inside the unit that can be repaired by the user. Have your device repaired or serviced by **authorised television technicians** only.



Only use **original accessories** such as Loewe stands, if possible.

Environmental protection

Cardboard box and packaging

In line with national regulations regarding the disposal of packaging materials, we pay a fee to authorised recyclers who collect packaging from dealers. Nevertheless, we recommend that you keep the original cardboard box and the rest of the packaging materials so that the device can, if necessary, be transported in the safest possible conditions.

The device



Attention: The EU Directive 2002/96/EC governs the proper return, handling and recycling of used electronic appliances. Old electronic devices must therefore be disposed of separately. Never dispose of this device in normal domestic waste! You can hand in your old unit free of charge at identified collection points or to your dealer if you buy a similar new unit.

Other details about return (also for non-EU countries) are available from your local authorities.





Batteries





The batteries provided contain no harmful materials such as cadmium, lead or mercury.

In accordance with the Battery Directive, used batteries should no longer be disposed of in the domestic waste. You can dispose of used batteries free of charge at the collection points in retail outlets. Your dealer will also have a collection point for used batteries.

Switching the device on/off

-  Switching the device ON / switching it OFF in Standby mode
-  BluTechVision operation ¹
-  TV operation
-  Call up TV-radio mode ¹













General navigation

-  Call up **Home** Menu, select the operating mode or the function
 ▲ ▼ If necessary, select medium **Disc - USB - Server - OK**
-  ◀ ▶ ◂ ▸ ▲ Navigation on the user interface, select objects - **OK**









Insert disc

-  Button on the device



Play

-  Play
-  Pause
-  Stop (Continue)
-  Stop (2x)
-  Short: previous chapter
 Long: search backwards (press several times)
-  Short: next chapter
 Long: search forwards (press several times)
-  **P+/P-** Next/Previous chapter
-  **V+/V-** Increase/reduce volume
-  Sound on/off
-  Single image - press several times
-  Slow motion forwards-  long press, then press several times

Key functions

-  Call the menu
-  Step-by-step backwards /Close menu
-  Title Menu ◀ ▶ ◂ ▸ ▲
-  Disc Menu (Blu-ray Disc™/DVD) ◀ ▶ ◂ ▸ ▲
-  Pop-UP Menu (Blu-ray Disc™) ◀ ▶ ◂ ▸ ▲
-  Picture Mode Menu ◀ ▶ ◂ ▸ ▲
-  Repeat/random playback- press several times - **OK**
-  HDMI resolution
-  Zoom Menu

Function of the coloured keys in zoom mode

-  **Green button** Zoom out
-  **Yellow button** Zoom in

Function of the coloured keys when playing back audio files

-  **Red button** Change device
-  **Green button:** Screen on/off (Music)

BD-LIVE™

-  Pop-UP Menu (Blu-ray Disc™) - ◀ ▶ ◂ ▸ ▲ - submenu / BD-LIVE™ Menu - ◀ ▶ ◂ ▸ - **OK**

¹ The assignment of these keys can be changed. The description refers to the standard setting.

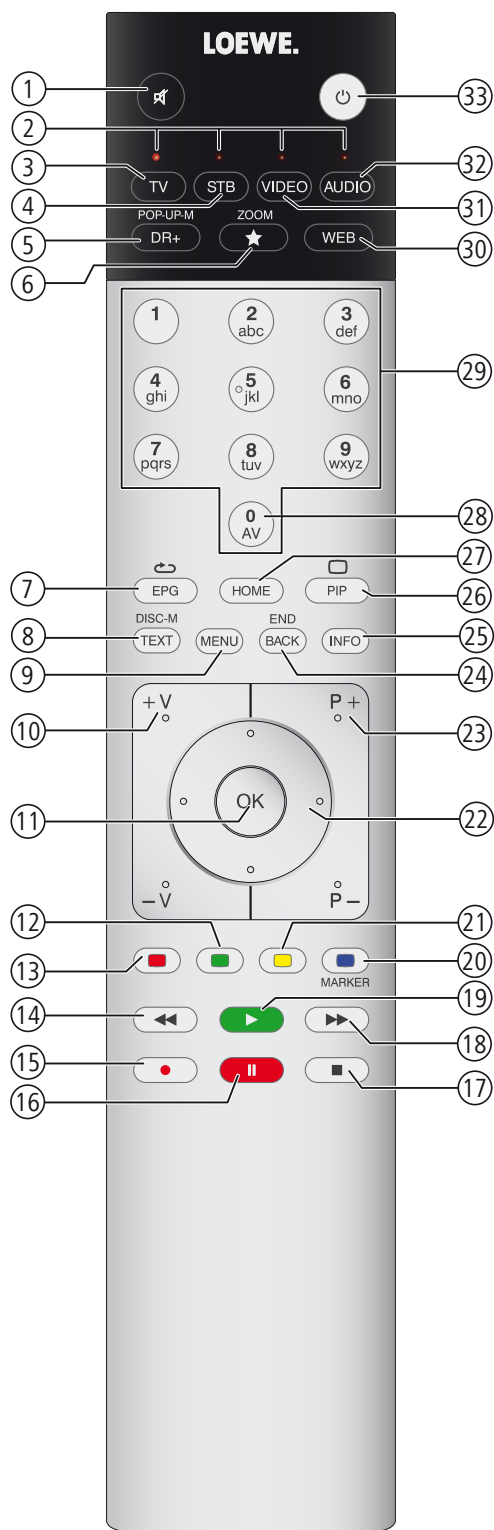

- ① Sound off/on
- ② LED display for currently operated device
- ③ Switch over to TV mode (page 10)
- ④ Reassign remote control to SetTop-Box (PACE DS440N)¹
- ⑤ Pop-Up / Disc Menu (page 23)
- ⑥ Zoom Menu (page 22)
- ⑦ Repeat / random playback (page 20)
- ⑧ DISC: Menu of the BD/DVD that is inserted (page 23)
- ⑨ Settings Menu (page 11)
- V+ / V-** Increase/reduce volume
- ⑪ In the menu: Confirm/call up (page 11)
- ⑫ Green coloured key: screen on/off (page 24)
- ⑬ Red colour button: Music: change device (page 25)
- ⑭ Short: previous chapter
Long: search backwards (press several times) (page 20)
- ⑮ HDMI resolution (page 26)
- ⑯ Pause (page 20)
- ⑰ Stop (page 20)
- ⑱ Short: next chapter
Long: search forwards (press several times)
- ⑲ Playback (page 20)
- ⑳ Blue button: zoom: normal display (page 22)
- ㉑ Yellow coloured button: Zoom: zoom in (page 22)
- ㉒ In the menu / lists: Select/Set (page 11)
- ㉓ **P+ / P-** DISC: Select title up/down (page 21)
FILE: Skip forward/backwards in the list (page 21)
- ㉔ Close menu (page 11)
- ㉕ Title Menu (page 21)
- ㉖ Picture Mode Menu (page 22)
- ㉗ Main Menu (page 11)
- ㉘ MENU: enter numbers (page 14)
- ㉙ MENU: enter numbers (page 14)
- ㉚ TV: Call up the web browser
- ㉛ Reassign remote control to **BluTechVision 3D**¹ (page 10)
- ㉜ Switch over to TV-radio mode¹
- ㉝ Switch on/off to standby mode (page 10)

The key assignment displayed here is valid for the main menu level of the device. The key assignment may vary in certain operating modes (see the corresponding chapter in this operating manual).

¹ The assignment of these keys can be changed. The description refers to the standard setting.
 The remote control code 21 is used for the BluTechVision 3D.
 If a remote control is not included with the device, the remote control for the Loewe TV set should be used.



- ① **Switch on/off to stand-by mode**
 The device will be completely separated from mains only when you unplug the mains cable.
- ② **CD/DVD/Blu-ray disc drive**
- ③ **Open / Close disc drawer**
- ④ **Display**
- ⑤ **Play / Pause**
- ⑥ **Stop**
- ⑦ **HDMI resolution**

- ⑧ **USB socket**
- ⑨ **Next chapter**
- ⑩ **Previous chapter**
- ⑪ **IR receiver:**
 Infrared receiver for receiving the remote control commands.
- ⑫ **Front flap**
- ⑬ **Operating display**

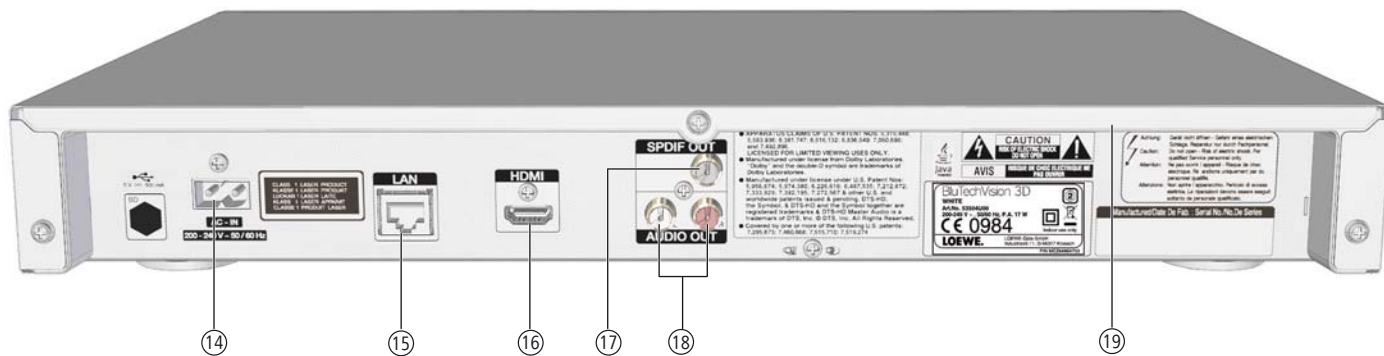

- ⑭ **Mains socket**
- ⑮ **LAN** (RJ-45 network connection)
- ⑯ **HDMI** (HDMI output)

- ⑰ **SPDIF OUT**
 Digital audio output
- ⑱ **AUDIO OUT**
 (Analog audio output stereo L/R)
- ⑲ **Connector panel cover**

BluTechVision 3D cable

Connect the **HDMI** socket of the **BluTechVision 3D** to an **HDMI IN** (HDMI 1/2/3/...) socket on your TV set using the HDMI cable provided.

Use an optional RJ-45 network cable (not included in the delivery) to connect the **BluTechVision 3D** to a network connection (e.g. switch or DSL router) that has a connection to the Internet/home network. Alternatively, you can connect the device to your home network via WiFi (page 16)

Plug the small plug of the mains cable into the rear of the unit (page 8) and then plug the large plug of the mains cable into a 220-240V 50/60 Hz socket.

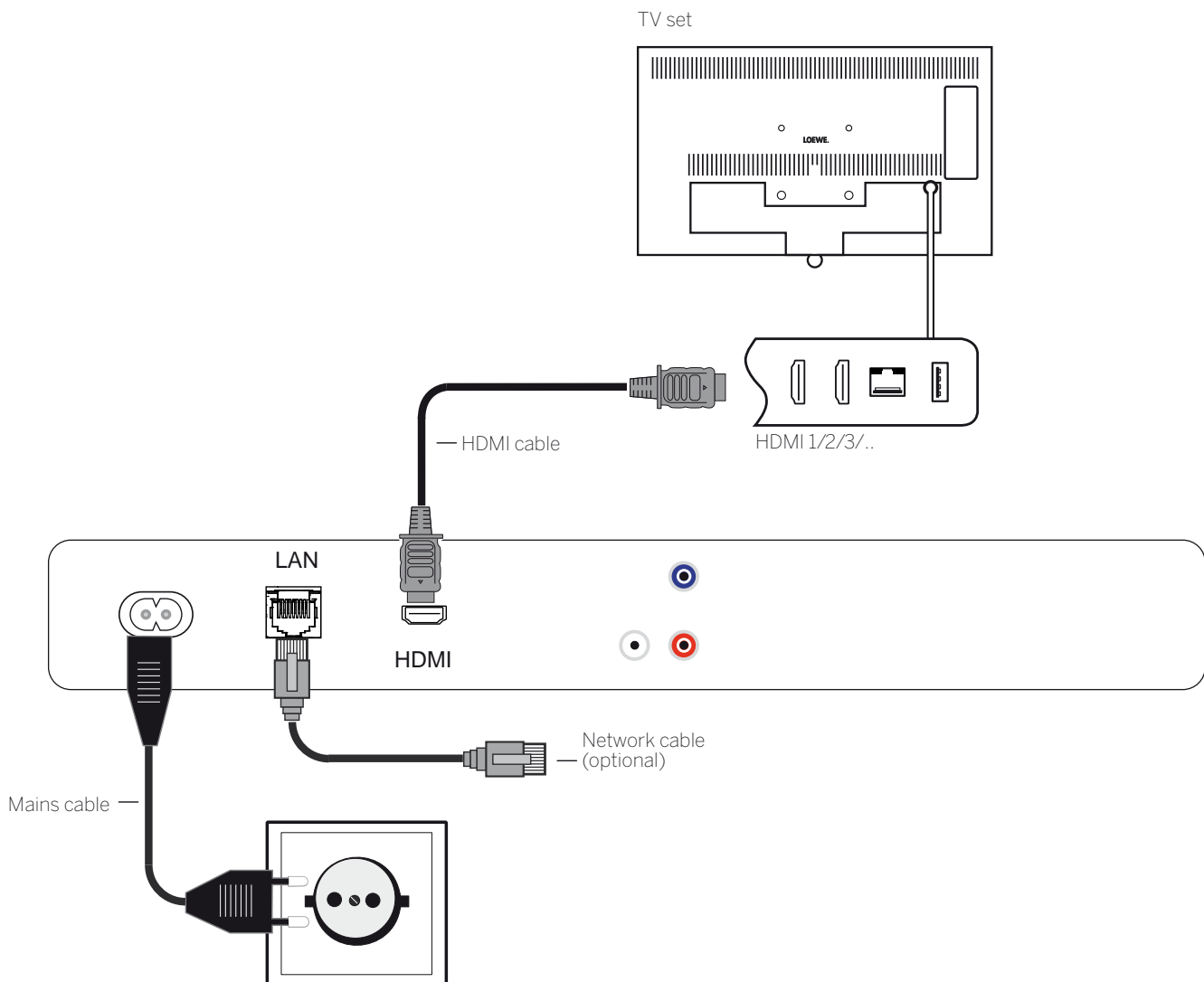

Preparing the remote control unit

Inserting or replacing batteries

Press on the embossed arrow whilst pushing the battery cover down to remove it.

Only use leak-proof micro-cells of the LR 03 (AAA) Alkali-Manganese type. Do not use different types of batteries and old and new batteries together.

The batteries used must not be exposed to excessive heat such as sunlight, fire or similar!

Pay attention to the correct polarity of + and - when inserting the batteries.

If the batteries are too weak after longer use, the Loewe TV set prompts you to change the batteries.

Dispose of used batteries in an environmentally friendly way (see page page 5).

Push the cover back on from below after having inserted the batteries.



Activate/deactivate



Set the remote control for **BluTechVision 3D** operation by pressing the **VIDEO** button briefly.

Your **BluTechVision 3D** switches on. If you have connected a Loewe TV set (L271x/SL1xx/SL2xx/SL3xx) via HDMI, this will then switch on as well. Otherwise (MB180), switch your TV set on and set the respective AV programme slot.

i If necessary, you may have to set the operation of the **BluTechVision 3D** to the AV socket used on your TV set (see, for example, "Operating additional devices" in the relevant instructions for use of your TV set).

As soon as **MediaVision 3D** is ready for operation, the **operating display** (13) (page 8) lights up green.



To switch off the device, press the OFF/ON knob on the **BluTechVision 3D** or once again on the **Assist** remote control.

Digital Link HD

With Digital Link HD, Loewe TV sets and other TV sets that support the CEC standard send the remote control signals via the HDMI connection from the TV set to the **BluTechVision 3D**.

i The TV set must be turned on.



Select the AV programme slot for HDMI on the TV set.

As long as HDMI is selected as a programme slot, most TV remote control commands (**ASSIST** remote control in TV Mode) are communicated to the connected HDMI device. However, the volume, sound on/off, sound adjustment and the TV Aspect Ratio continue to affect the operation of the TV set. These AUDIO commands (**ASSIST** remote control in AUDIO Mode) are not transmitted from the TV.



If you press the **TV button** for a longer time, you can toggle between HDMI and TV operation. Briefly pressing the **TV button** switches back to TV Mode.

The **TV button** (press briefly) can be used to switch to the last station viewed in TV Mode and quit the device control.

i A software update might be necessary for your Loewe TV set. Please contact your dealer.

General information on the operation

You will use some keys of the remote control for operating the device more often than others. The most important keys for navigation will be explained in general. The numbers in the text refer to the figure showing the remote control on page 7.

The **arrow keys** (22) help you to navigate in the menus and lists of the device and are used for selecting menu items. They are arranged in the middle of the remote control in a circle around the **OK** key (11). Later in this guide they will be represented as follows:



◀ ▶ ▲ ▼ Select the desired item.

The **OK** key (11) is used to confirm a selection, to call up the highlighted menu item and to start the playback. In this guide, an instruction for this key looks like this:



Press **OK** to confirm

The **Main Menu** is the central overview page for all of your device's operating modes. You reach the **Main Menu** by pressing the button **HOME** (27).



HOME: Call up the **Main Menu**.

Pressing the **BACK** (24) key closes all opened fade-ins. An example for the **BACK** key in this guide:



BACK: Cancel text entry and exit entry box.

If the function for a key is not available, this will be indicated by an inserted symbol (20) on the right above.

The remote control code 21 is used for the BluTechVision 3D.

If a remote control is not included with the device, the remote control for the Loewe TV set should be used.

Main Menu

The Main Menu of the **BluTechVision 3D** is shown on the screen of the TV set connected. Here you can select the required functions.

HOME Call up the **Main Menu**.

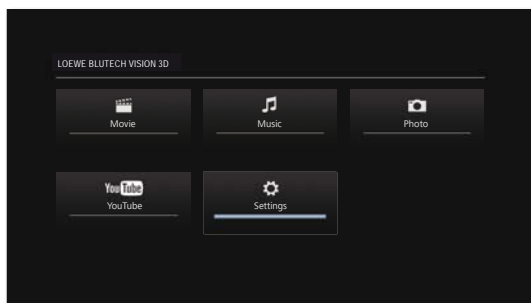

◀ ▶ Select the desired function.

Press **OK** to confirm.

Description of the individual functions:



Movie: Display the **Movie** Menu (page 24) for playing video files or the Disc Menu



Photo: Display the **Photo** Menu (page 26) for displaying photo files



Music: Display the **Music** Menu (page 25) for playing audio files



YouTube: Display the **YouTube** Menu (page 27) for playing internet videos



Settings: Display the **settings** Menu (page 11), to make settings

i To call up the Main Menu, close any other menus that might be open with **HOME**.

Language Menu

Your **BluTechVision 3D** attempts to automatically set the correct menu language via the HDMI-CEC connection to the same language as your Loewe TV set. You can also set the required menu language manually.

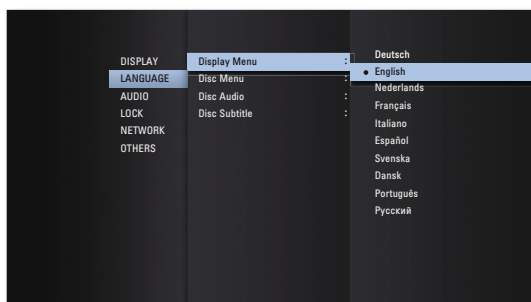

Call up **Settings** Menu.



▲ ▼ Select the **Language** option.

▶ ▲ ▼ Select the **Display Menu** option.

▲ ▼ Select the desired language.

Press **OK** to confirm.

Disc Languages

Select a language for the menu, the sound and the subtitle of the disc. If a language different to the "original" of the disc version is to be used, select this here if available on the disc.



▶ ▲ ▼ Select option **Disc Menu, Disc Audio** or **Disc Subtitle**.

▶ ▲ ▼ Select desired option.

Off Switch off disc subtitle

Original The original language of the disc is selected

Other Select another language (page 30).

Press **OK** to confirm.



Close menu.

Settings Menu

The **Settings** Menu allows you to make any settings and adjustments that might be necessary to e.g. your TV set.

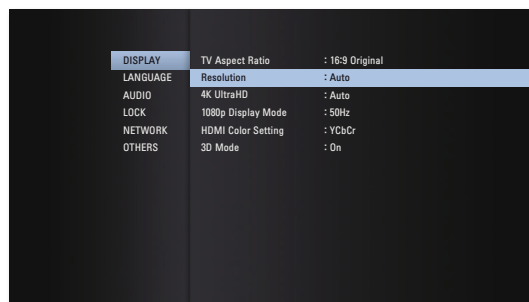

Call up **Settings** Menu.



▲ ▼ Select desired category.

▶ ▲ ▼ Select the desired subcategory.

▲ ▼ Make the desired setting.

Press **OK** to confirm.



Close menu.

i If the blue bar for the menu selection appears in the first level (left), you will see the settings currently valid in the overview in the third level (right).

Display Menu

In the **Display** Menu you can set the screen imaging of your **BluTech-Vision 3D** on your TV set.

i These settings are automatically made when the HDMI socket is used.

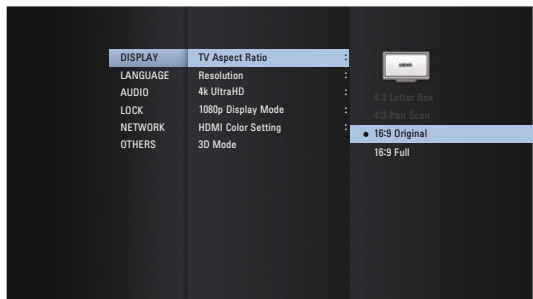

Call up **Settings** Menu.



▲ ▼ Select the **Display** option.

TV Aspect Ratio

▶ ▲ ▼ Select **TV Aspect Ratio** option.

- 4:3 Letterbox Select this setting if a standard TV set with 4:3 TV Aspect Ratio is connected. Recordings in wide-screen TV Aspect Ratio appear with a black bar at the top and bottom of the screen
- 4:3 Panscan Select this setting if a standard TV set with 4:3 TV Aspect Ratio is connected. The picture fills the entire screen, but crops the area on both sides if required.
- 16:9 Original Select this setting if a wide-screen TV set with 16:9 TV Aspect Ratio is connected. The 4:3 picture in the original 4:3 TV Aspect Ratio is displayed with black bars on the left and right of the screen.
- 16:9 Full Select this setting if a wide-screen TV set with 16:9 TV Aspect Ratio is connected. The 4:3 picture is stretched horizontally (with the same TV Aspect Ratio) so as to fill out the entire screen.

i Depending on the TV set, not all settings will be available.

Resolution

You can set the resolution of the video signal at the **HDMI** socket.

▶ ▲ ▼ Select the option **Resolution**.

- Automatic The picture is automatically set to the highest possible resolution depending on the TV set
- 576p Output in the 576 line Progressive Mode
- 720p Output in the 720 line Progressive Mode
- 1080i Output in the 1080 line Interlaced Mode
- 1080p Output in the 1080 line Progressive Mode

4K UltraHD

This function can be used to scale up video signals to the 4K/UltraHD mode.

▶ ▲ ▼ Select the option **4K UltraHD**.

Automatic If a 4K/UltraHD capable device is connected to **HDMI**, content can be scaled up to 4K/UltraHD and played back

Off Playback takes place without scaling

i This device only scales 24 Hz video material from Blu-ray discs into the 4K/UltraHD mode.

1080p Display Mode

Select the option **24Hz** to smoothly show movies on HDMI-compatible TV sets with 1080 lines at a frame rate of 24Hz.

▶ ▲ ▼ Select the option **1080p Display Mode**.

24HZ Frame rate 24Hz for cinema movies

50HZ Frame rate 50Hz for TV movies

i Picture disturbances can occur when changing between video and movie material in the **24Hz** setting. In this case, select the setting **50Hz**.

i Even if the option **1080p Display Mode** is set to **24Hz**, the actual frame rate of the video output will be specified at 50 Hz or 60 Hz depending on the format of the video source, if your TV set does not support the resolution 1080/24p.

HDMI colour setting

Select the video output signal depending on which TV set you have connected.

▶ ▲ ▼ Select the option **HDMI Colour Setting**.

YCbCr Choose this setting if an HDMI socket is being used on the TV set

RGB Choose this setting if an DVI socket is being used on the TV set

3D Mode

You can switch the 3D Mode on/off.

▶ ▲ ▼ Select the option **3D Mode**.

On If a 3D capable device is connected to HDMI OUT, 3D content can be played back

Off Blu-ray™ 3D media will be played back in 2D

Audio Menu

You can make various sound settings in the **Audio** Menu.

i These settings are automatically made when the HDMI socket is used.

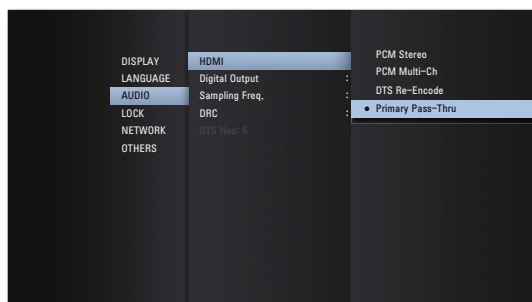

Call up **Settings** Menu.



▲ ▼ Select the **Audio** option.

HDMI/Digital output

The digital audio signal that is output at the **HDMI** or **SPDIF OUT** (page 8) socket can be set up.

- PCM Stereo Choose this option if a device with a dual-channel stereo amplifier is connected to the BluTechVision3D
- PCM multi-channel Choose this option if a device with a digital multi-channel decoder is connected to the BluTechVision3D (only HDMI)
- DTS Re-Encode Choose this option if a device with a DTS decoder is connected to the BluTechVision3D
- Primary Pass-Thru Choose this option if a device with a Dolby Digital Plus, Dolby True HD, DTS or DTS HD decoder is connected to the BluTechVision3D

i If the option **HDMI** is set to **PCM multi-channel**, the sound may be output as PCM stereo sound, if the PCM multi-channel information cannot be determined by the TV set.

Sampling Freq.

If you use the **HDMI** or **SPDIF OUT** socket, you can set the sampling freq.

- 48kHz Choose this option if the device that you have connected cannot process 192 kHz or 96 kHz signals. If you select this option, your BluTechVision 3D will automatically convert 192 kHz and 96 kHz signals into 48 kHz signals
- 96kHz Choose this option if the device that you have connected cannot process 192 kHz signals. If you select this option, your BluTechVision 3D will automatically convert 192 kHz signals into 96kHz signals
- 192kHz Choose this option if the device that you have connected can process 192 kHz signals

DRC

You can use the DRC (night mode) function to limit the dynamics (in other words, the difference between the loudest and quietest sounds). In this way, you can also play a movie with lower volume differences (e.g. at night).

- Automatic Select this option if you wish to play audio signals with the coding Dolby True HD with reduced dynamics
- Off Audio signals are played with the full dynamic range
- On Select this option if you wish to play audio signals with the coding Dolby Digital or Dolby Digital Plus with reduced dynamics

DTS Neo: 6

If the device is connected to an AV receiver via **HDMI**, 2-channel audio signals can be played back in multi-channel surround quality

- i** Only audio signals with a sampling frequency of up to 48 kHz are possible for this function.
- i** This option is only available if the **HDMI** option is set to the **PCM multi-channel**.
- Off Stereo playback via front speakers
- Music Choose this option if you wish to play stereo music in multi-channel quality
- Cinema Choose this option if you wish to play a movie in multi-channel quality

Lock Menu

You can specify playback restrictions in the **Lock** Menu.

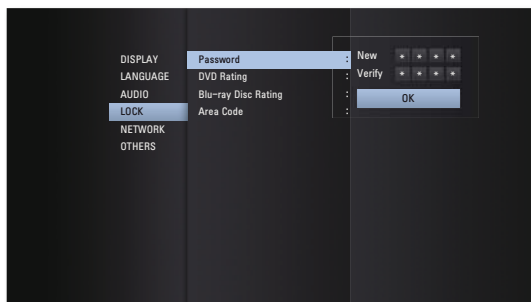

Call up **Settings** Menu.



▲ ▼ Select the option **Lock**.

Password set-up

Please set your personal password.

◀ ▶ ▲ ▼ Select the option **Password**.

▶ Select the option **New**.



Use the numerical buttons to enter a four-digit password.

Confirm the new password.

Press **OK** to confirm.

i If the entry is incorrect before you press **OK**, repeatedly press ◀ to clear the numbers.

Resetting the password

If you have forgotten the password or wish to deactivate the password function, you can reset it.

i Remove every medium (disc, USB) and close all menus.



Call up **Settings** Menu.

▲ ▼ Select the option **Lock**.

▶ Select the option **Password**.



Use the numerical buttons to enter the code number (page 30).

The password protection is now deactivated. If necessary, set up a new password, as described under "Password set-up".

DVD Rating

This function restricts the playback of DVDs with adult-only content, if these contain a corresponding code. You will be prompted to enter the password to play the content in full.

◀ ▶ ▲ ▼ Select the option **DVD Rating**.

Press ▶ button.

Use the numerical buttons to enter the current four-digit password.

Press **OK** to confirm.

▲ ▼ Select desired option.

Lift restriction The disc is played fully

Ratings 1 to 8 Only the scenes of the inserted discs corresponding to the assigned security rating or whose rating is below this are played. Level "1" has the most playback restrictions

i Not all discs include a rating.

Blu-ray Disc Rating

This function restricts the playback of Blu-ray Discs™ with adult-only content, if these contain a corresponding code. You will be prompted to enter the password to play the content in full.

◀ ▶ ▲ ▼ Select the option **Blu-ray Disc Rating**.

Press ▶ button.



Use the numerical buttons to enter the current four-digit password.

Press **OK** to confirm.



Use the numerical buttons to enter the three-digit code for the age rating (you can find this code on the Blu-ray Disc™ or on the accompanying material).

Press **OK** to confirm.

255 The disc is played fully

0 to 254 Only the scenes of the inserted discs corresponding to the assigned security rating or whose rating is below this are played. Code "0" has the most playback restrictions

i Not all discs include a rating.

Area Code

To utilise the playback restrictions for the discs, enter the area code for the relevant country (for the list see page 30).

◀ ▶ ▲ ▼ Select option **Area Code**.

Press ▶ button.



Use the numerical buttons to enter the current four-digit password.

Press **OK** to confirm.

▲ ▼ Select the required code.

Press **OK** to confirm.

Network Menu

Your **BluTechVision 3D** can be connected to a home network with an Internet connection via the LAN connection on the rear (page 8) or via **WiFi**.

Wired network

If your home network has a DHCP server (e.g. a DSL router), **BluTechVision 3D** can set up all the network parameters automatically.



Call up **Settings** Menu.



▲ ▼ Select the **Network** option.
 ▶ ▲ ▼ Select the option **Connection Setting**.

Press **OK** to confirm.

The **Network Setting** Menu appears.

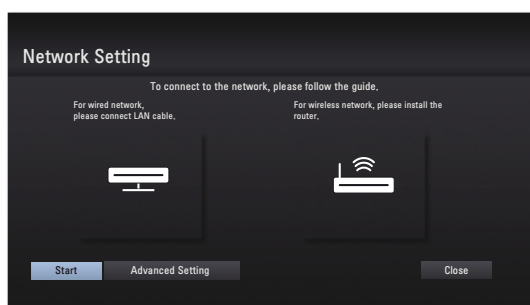

▲ ▼ Select the option **Start**.

Press **OK** to confirm.

Your **BluTechVision 3D** searches for available LAN/WiFi connections in your home network and automatically selects one of the LAN connections that is present.

If the connection test was successful, a corresponding message will be displayed.

Connection Status Menu

You can display the network parameters currently set.



Call up **Settings** Menu.



▲ ▼ Select the **Network** option.
 ▶ ▲ ▼ Select the option **Connection Status**.

Press **OK** to confirm.

The **Connection Status** Menu appears

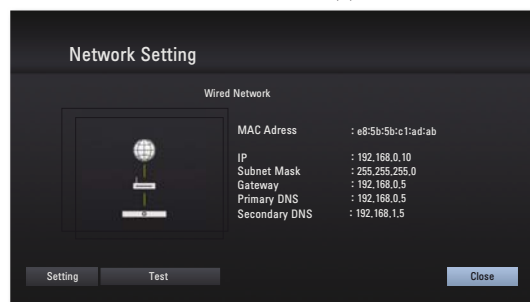

Test Perform connection test

Setting Display **Connection Setting** menu

Manually set up the network connection

The network parameters can be set manually (e.g. if there is no DHCP server in your home network).



Call up **Settings** Menu.



▲ ▼ Select the **Network** option.
 ▶ ▲ ▼ Select the option **Connection Setting**.
 ▶ ▲ ▼ Select the option **Advanced Setting**.

Press **OK** to confirm.

▶ ▲ ▼ Select the option **Wired**.

The **IP Address & DNS Setup** Menu appears.

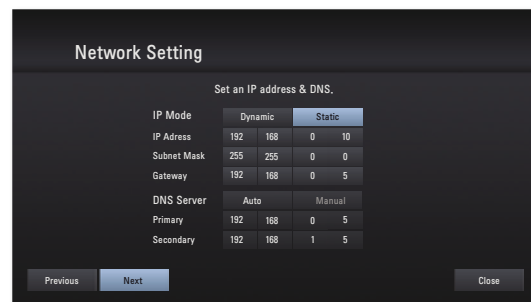

▲ ▼ ◀ ▶ Select the option **IP Mode: Static**.



▲ ▼ ◀ ▶ Input the **IP Address**, **Subnet Mask** and **Gateway** using the numerical buttons on the Assist remote control.

▲ ▼ ◀ ▶ Select the option **DNS Server: Manual**.

▲ ▼ ◀ ▶ Enter the **Primary** and poss. **Secondary DNS server** address using the numerical buttons on the Assist remote control.

▲ ▼ ◀ ▶ Select the option **OK**.

Press **Next** to confirm.

Your **BluTechVision 3D** will now use the given parameters to attempt to establish a connection to the Internet router in your home network.

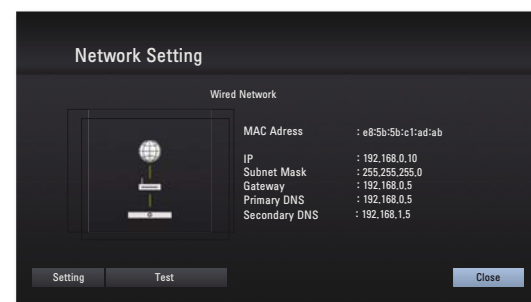

If the connection test was successful, a corresponding message will be displayed in the **Connection Status** Menu.

Wireless network

Loewe recommends use of a wired network (LAN, Ethernet, Powerline) to ensure a high stability and quality of the data link. As a matter of principle, wireless connections can get disturbed due to external influences (e.g. microwave devices) and mostly provide a lower data transmission rate.



Call up **Settings** Menu.



▲ ▼ Select the **Network** option.
 ▶ ▶ ▼ Select the option **Connection Setting**.

Press **OK** to confirm.

The **Network Setting** Menu appears.



▲ ▼ Select the option **Advanced Setting**.

Press **OK** to confirm.

▲ ▼ Select the option **Wireless**.

Press **OK** to confirm.

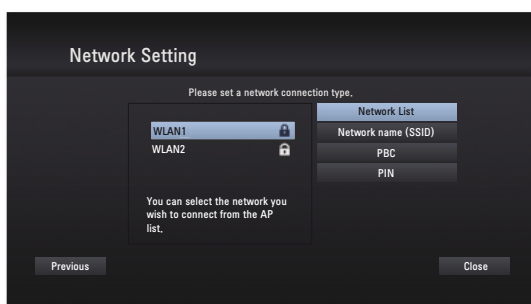

There are several methods by which your **BluTech-Vision 3D** can establish a wireless connection.

Network List Select a WiFi network from the list

Network name Enter the network name (SSID)

PBC Press the WPS button on the router

PIN Enter the router's PIN on its website.



▲ ▼ Select the required connection type.
 Press **OK** to confirm.

When selecting the **Network List** type, select the desired WiFi connection and then enter the network password.

Setup the IP Address (where necessary) and the DNS (page 15) or click **Next**.

If the connection test was successful, a corresponding message will be displayed.

BD-LIVE™connection

You can specify whether your **BluTechVision 3D** may establish an Internet connection to the **BD-LIVE™** service (page 23).



Call up **Settings** Menu.



▲ ▼ Select the **Network** option.
 ▶ ▶ ▼ Select the option **BD-LIVE™ Link**.

Press **OK** to confirm.

Permitted BD-LIVE™ is permitted for all contents

Partially permitted BD-LIVE™ is only permitted for content for which a user certificate is available.

Prohibited BD-LIVE™ is locked

Device name

You can give the unit an individual name for identification in the network.



Call up **Settings** Menu.



▲ ▼ Select the **Network** option.
 ▶ ▶ ▼ Select **Device Name**.

Press **OK** to confirm.

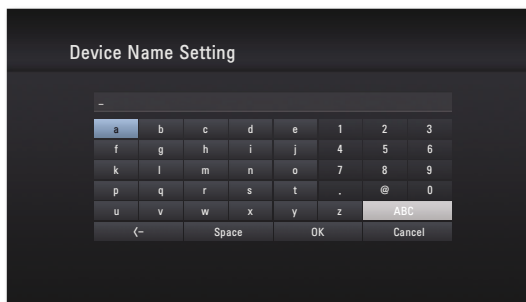

The menu **Device Name Setting** is displayed.

◀ ▶ ▲ ▼ Select the letter/number/function
 Press **OK** to confirm.

<- Clear a character

Space Insert space

OK Save name

Cancel Do not save name

Others Menu

Blu-ray Disc Storage Select

You can set whether you wish to use the integrated memory of the device or a memory connected to the USB socket for the BD-LIVE function.



Call up **Settings** Menu.



▲ ▼ Select **Others** option.

▶ ▲ ▼ Select the option **Blu-ray Disc Storage Select**.

Built-In Storage Memory integrated in the device

USB Storage Memory connected to the USB socket of the device

Press **OK** to confirm.

Blu-ray Disc Storage Clear

You can clear the memory used for the BD-LIVE function (page 23) so that more space is freed up for new files.



Call up **Settings** Menu.



▲ ▼ Select the option **Others**.

▶ ▲ ▼ Select the option **Initialize**.

▶ ▲ ▼ Select the option **Blu-ray Disc Storage Clear**.

Press **OK** to confirm.

◀ ▶ Confirm security query with **Yes**.

DivX® VOD

You will receive the DivX® VOD (Video On Demand) registration code for borrowing and buying movies via the DivX® VOD service.



Call up **Settings** Menu.



▲ ▼ Select the option **Others**.

▶ ▲ ▼ Select the option **DivX® VOD**.

Register The registration code that is valid for your device is displayed. You can register for the VOD service on the Internet at: <http://vod.divx.com> You can also find further information on the use here.

Deregister The deactivation code valid for your device is displayed.

Press **OK** to confirm.

i All movies purchased via DivX® VOD can only be played on this device.

Network Play

You can set whether your unit may be controlled remotely from DLNA compatible devices (Digital Media Controller). This means that you can play music from a DLNA compatible audio server (Digital Media Server) via BluTechVision 3D.



Call up **Settings** Menu.



▲ ▼ Select **Others** option.

▶ ▲ ▼ Select **Network Play** option.

On The network replay is enabled

Off The network replay is disabled

Press **OK** to confirm.

Auto Power Off

To save energy, you can set the device so that it switches off automatically after a certain time without playback.



Call up **Settings** Menu.



▲ ▼ Select the option **Others**.

▶ ▲ ▼ Select the option **Auto Power Off**.

Off The device also remains switched on after a longer period without use

On After 20 minutes without function, the device will automatically switch off to Standby Mode

Press **OK** to confirm.

Initialize

You can reset the device to the factory set.



Call up **Settings** Menu.



▲ ▼ Select the option **Others**.

▶ ▲ ▼ Select the option **Initialize**.

▶ ▲ ▼ Select the option **Factory Set**.

Press **OK** to confirm.

◀ ▶ Confirm security query with **Yes**.

Updating software

Display the software status



Call up **Settings** Menu.



- ▲ ▼ Select the option **Others**.
- ▶ ▲ ▼ Select the option **Software**.
- ▶ ▲ ▼ Select the option **Information**.

Press **OK** to confirm.

An information page will be displayed.

You can see the current software in the device on the right next to the entries **PACK VER**, **MAIN VER** and **SERVO VER**.

Press **OK** to confirm.

Downloading new software

If your device is connected to the internet via your home network, you can download any software updates that are available directly to it. Alternatively, you can download a software update suitable for your device from the Loewe Support Portal onto a USB stick, if required.

- Enter the following address into the Internet browser of your computer: <http://support.loewe.tv>
- If you still do not have your own access to the Loewe Support Portal, set it up now. Click on [Register free-of-charge](#). Fill out the information for your account and then click on [Create account](#). Please check whether all data is correct and then click on [Create account now](#). Shortly thereafter, you receive an email at the already specified address. Click on the link given above to confirm your registration. After successful registration, you will receive an email for confirmation.
- Enter **your email address** and a **password** under **Access to your account**.
- Click on **Register Loewe product - BluTech - BluTechVision 3D** and enter the requested data for your device.

Download the file shown in the **Software** area.

Unzip the downloaded file (e.g. with 7-zip) and copy the two unzipped files to a USB stick.

- ❗ The file system of the USB sticks must be formatted in the format FAT32 and only one partition may be present. The player does not support other file systems.

Updating the device's software



Switch on your **BluTechVision 3D** (and the TV set connected to it).



Remove an inserted disc.



Call up the Main Menu.

Software update via the Internet



Call up **Settings** Menu.



- ▲ ▼ Select the option **Others**.
- ▶ ▲ ▼ Select the option **Software**.
- ▶ ▲ ▼ Select the option **Update**.

Press **OK** to confirm.

If a software update is available, confirm the download by pressing **YES**.

The update process starts and you can see a progress display.

The device switches off automatically after a successful update. Switch the unit on again after 20 seconds.

Software update via USB

Insert the USB stick with the update files into the USB socket of the **BluTechVision 3D** and wait until the device has recognised the USB stick.

The software found on the USB stick is checked and a message appears. If the software is more recent than that on the device, you can then start the update.



- ◀ ▶ Select **Yes** to confirm the security query.

Press **OK** to confirm.

The update process starts and you can see a progress display.

- ❗ The USB stick or the mains cable must never be disconnected from the device during the updating process!

The device switches off automatically after a successful update. Switch the unit on again after 20 seconds.

- ❗ The firmware update is only intended for the Loewe **BluTechVision 3D**, art. no. 53504!
- ❗ Only use the software approved by Loewe for your device!
- ❗ You can find the model designation on the rear of the device.
- ❗ If another device from Loewe or from a different manufacturer is loaded with software not intended for the device, this can lead to damage. Any guarantee and recourse claims for the device shall consequently lose their validity.
- ❗ The firmware update does not result in any significant changes to the technical functions of the device.
- ❗ You can download a current version of the instructions for use as a PDF file from the Loewe web page: <http://support.loewe.tv> – [User guides](#). This is especially recommended after a software update.

Playing discs

Preconditions

Once you have carried out the relevant steps described in the chapters "Set-up", "Connection" and "Start-up", switch on **BluTechVision 3D** and any connected devices. To reproduce 3D content, you require a 3D-compatible TV set with 3D glasses compatible with this, as well as Blu-ray™ 3D media.

Playable discs

Only use discs that conform with the current standards. You can recognise these from the logos attached.

Disc type		Recording format	Contents	Disc size
Blu-ray™/Blu-ray 3D™	Regional code ** / ALL	Video Mode	Audio + Video (movie)	12 cm (5")
BD-RE/BD-R *		-		
DVD Video	Regional code ** / ALL	Video Mode	Audio + Video (movie)	12 cm (5")
DVD±RW/DVD±R *		Video Mode	Audio + Video (movie)	12 cm (5")
Audio CD *		Audio CD (CD-DA)	Audio	12 cm (5")
CD-RW/CD-R *		Audio CD (CD-DA)	Audio	

* only finalised discs

** for the regional code applicable for your set, see the back of the set

Regional code (Area Code)

The regional code of this player is printed on the reverse side of the device. Only Blu-ray™ or DVD discs with this regional code or with the regional code "ALL" can be played. The regional code on the labels of some DVDs shows which type of DVD player can be used to play these discs. If you play other discs, an error message will be displayed on the TV screen. Some discs may not have the label with the regional code, although they cannot be played in all regions.

Symbols in these instructions for use

BD Blu-ray Disc™

DVD-V DVD video disc

CD Audio CD

DivX: DivX files

MP3: MP3 files

WMA: WMA files

JPEG: JPEG files

Handling discs

Do not touch the playing side of the disc. Hold the disc at the edges so as not to touch the surface with your fingers. Do not attach paper or adhesive tape onto either side of the disc.



- i** Discs cannot be played if the disc is damaged or dirty or if the lens of the player is contaminated with condensation.
- i** If you write a disc using a PC, the disc may not be playable due to the settings of the application software with which it was created, even if the format is compatible. (You can obtain more information from your software provider).
- i** Depending on the recording device or the CD-R/RW- (or DVD±R/±RW-) disc itself, some CD-R/RW- (or DVD±R/±RW) discs cannot be played with this device.
- i** Do not use CDs with unusual shapes (e.g. heart shaped or octagonal). Otherwise malfunctions or damage cannot be ruled out.
- i** Finger prints and scratches on the disc can impair the playing quality. Handle the discs carefully.

Inserting discs

The disc drawer of your **BluTechVision 3D** is located behind the front flap (page 8). To open the disc drawer, press the sensor button on the unit . Place the disc into this drawer. The printed side of the disc should face upwards. Press the button again to close the disc drawer.



Ejecting the disc

To remove the inserted disc press again.

Playback in general

Your **BluTechVision 3D** attempts to read the disc. During this **READ** is shown in the display.

Depending on the medium, the playback starts automatically or a disc menu is displayed. Follow the instructions on the screen or note the disc documentation.



▲ ▼ ◀ ▶ Select title.

OK Start play.



Play Start / Continue playback.



Pause Stop play.



Press briefly: Next chapter.



Press briefly: Start of the chapter.



Press briefly twice: Previous chapter.



Press **Stop** twice: End play.



Display Title Menu.



In the Title Menu you can - if the disc currently being played supports it - set a selection of options, e.g. title / chapter selection or subtitle (see also page 21).



▲ ▼ Select option.

◀ ▶ Set option.

Press **OK** to confirm.

i If the child protection rating of the disc is set higher than that for the movie rating, the password must be entered (see **Rating** on page 14).

Search

BD DVD-V DivX CD

Select the search direction and speed:



Long press: rewind. Increase the playback speed backwards by pressing several times.



Long press: fast-forward Increase the playback speed forwards by pressing several times.

The speed and direction are indicated as an arrow.



Quit Search Mode and continue playback.

Freeze frame and picture-for-picture playback

BD DVD-V DivX



Pause Stop play.



Press **Pause** again: Browse forwards by frames.



Resume play

Slow motion

BD DVD-V DivX



Pause: Stop play.



Press longer: Activate Slow motion mode during pause.



Select the slow motion speed:

IIII>, III>, II>, I> (forwards).



Quit Slow motion mode and continue playback.

Repeat

BD DVD-V CD MP3



Press several times to select the type of repeat.



Random playback



Repeats the selected section (page 22)

Chapter

Repeats the current chapter

Titles

Repeats the current title



Repeats the current track



Repeats all titles/tracks on the disc



Off No repeat

Disc playback

You can display various information on the inserted disc on the screen and set options for the playback.

 Call up Title Menu during play.

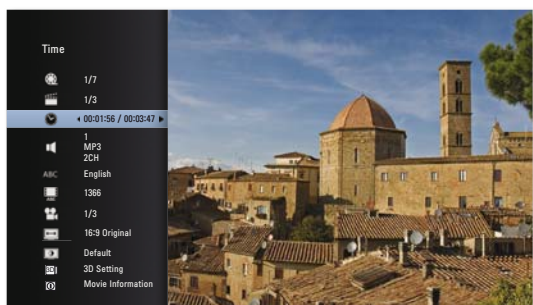

▲ ▼ Select the desired function.

Title	Current title (or track number)/total number of titles
Chapter	Current chapter number/total number of chapters
Time	Elapsed play time, go to time with OK
Audio	Selected sound formats, movie language and audio channels
Subtitle	Selected subtitle
Code Page	Code table for subtitle (page 30)
Angle	Selected camera angle / Total number of camera angles
TV Aspect Ratio	Selected TV aspect ratio (e.g. aspect ratio 16:9)
Picture Mode	Selected Picture Mode (e.g. optional colour setting page 22)
3D Setting	3D Mode for 2D videos
Movie information	Display media information from internet databases (Gracenote) ¹

Title selection

BD DVD-V DivX



Display Title Menu.



▲ ▼ Select **Title** .

◀ ▶ Select title number.

OK Start playing the selected title.

Title selection

CD DivX MP3 JPEG



P+ during play in order to select the next title/photo or use **P-** to return to the start of the current title.

Press **P-** briefly twice to return to the previous title.

Chapter / Track selection

BD DVD-V DivX

If a title has several chapters/tracks, you can select another chapter/another track as follows:



Press **P+** or **P-** during playback in order to select the next chapter/track or to return to the start of the current chapter/track.

Press **P-** briefly twice to return to the previous chapter/track.

Time (Play from ...)

BD DVD-V DivX

The **Time** function allows you to begin playing a disc from whichever point you like.



Display Title Menu.

The elapsed play time for the current disc is shown in the **Time** field.



▲ ▼ **Select**  Time.



Enter time in the format hh:mm:ss.

OK Start play from the time point entered.

Digital sound formats, movie language and audio channels

BD DVD-V DivX

Here you can select the digital sound format in conjunction with the movie language.



Display Title Menu.



▲ ▼ Select **Audio** .

◀ ▶ Select another movie language or sound format (*BD, DVD-V, DivX*) - if available.

Subtitle

BD DVD-V DivX



Display Title Menu.



▲ ▼ Select **Subtitle ABC**.

◀ ▶ Select subtitle language - if available.

Angle

BD DVD-V

If the disc contains scenes that have been recorded at different camera angles, you can change to another camera angle during play.



Display Title Menu.



▲ ▼ Select **angle** .

◀ ▶ Select the desired camera angle - if available. The number of the current camera angle is shown.

I A camera symbol is shown on the screen for scenes that have been recorded in different camera angles.

¹Internet connection required

TV Aspect Ratio

BD DVD-V DivX



Display Title Menu.



▲ ▼ Select the **TV Aspect Ratio** option

◀ ▶ Select the TV aspect ratio - if available.

Picture Mode

BD DVD-V DivX



Display Title Menu.



▲ ▼ Select **Picture Mode**

◀ ▶ Select Picture Mode (page 23) - if available.

Zoom

BD DVD-V JPG

You can use the zoom function to magnify the video image during play and navigate in the magnified image.

Open Zoom display.



Green button Zoom out

Yellow button Zoom in

Blue button Normal view



◀ ▶ ▲ ▼ Move picture detail.



Close Zoom window.

i The Zoom function might not work for certain discs.

Disc Menu

DVD-V

Video discs mostly contain menus



Call up **Disc Menu**.



▲ ▼ ◀ ▶ Select desired option.

Press **OK** to confirm.

Repeat section (A-B)

BD DVD-V



At the beginning of the section to be repeated, press the button several times until the symbol is displayed:



Press **OK** at the end of the section to be repeated.



Press the EPG button several times until the symbol is displayed: **Off**

Flagging the last scene

BD DVD-V

Your **BluTechVision 3D** remembers the scene last played on the previous disc (Blu-ray Disc™, video DVD). The position of the last scene is saved in the memory, even when the disc is taken out of the device or when the device is switched off (or is in Standby Mode). The next time you insert this disc, the saved scene will be played automatically.

- i** The function "Flag last scene" is reset when inserting a new disc.
- i** This function is not possible with certain discs.
- i** The function "Flag last scene" is not possible for BD video discs with BD-J.
- i** The settings for a disc are not saved if the device is switched off before the disc is played.

Disc Menu

BD

Some discs contains menus for settings e.g. the language for the movie sound or subtitle or selecting certain scenes. Accompanying movie material can also be available. These menus have individual layouts, depending on the disc.

DR+ Select **POP-UP-M** Pop-Up/Disc Menu Example:

i Depending on the disc, there might not be any such menu. This button will not then have any function.



▲ ▼ ◀ ▶ Select menu item.

Press **OK** to confirm.



It may be possible to select menu functions with the coloured buttons.

DR+ End **POP-UP-M** Pop-Up/Disc menu.

Picture Mode

You can make various settings for the screen imaging during play.

PIP **Picture Mode** Menu.

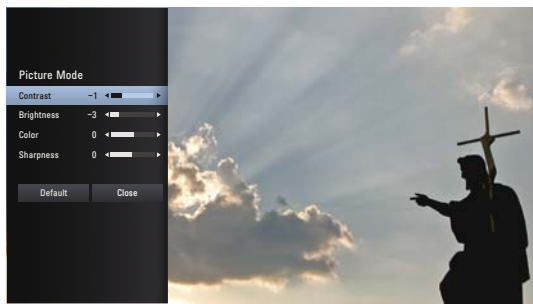

▲ ▼ ◀ ▶ Select/Set options.

Contrast Set contrast

Brightness Set screen brightness.

Colour Set colour saturation

Sharpness Set contour definition of the picture

PIP End **Picture Mode** Menu

3D Setting

You can select the 3D Mode for 2D videos.

INFO Display Title Menu.



▲ ▼ Select **3D Setting** **3D**.

3D 3D Mode on/off

Depth Depth effect Low/Medium/High

Distance 3D distance Near/Medium/Far

BD-LIVE™

Your **BluTechVision 3D** supports the **BD-LIVE™** function (Blu-ray™ Profile 2.0). This allows you to access interactive content provided via the Internet by some Blu-ray Discs™ providers.

Insert the Blu-ray Disc™ with the **BD-LIVE™** function.

i The **BD-LIVE™** function requires a broadband Internet connection. Set up the access to your home network as described from page 16.

i Activate the option whereby your **BluTechVision 3D** can set up an online connection to the **BD-LIVE™** service (page 16).

i Ensure sufficient free memory space for the **BD-LIVE™** content by clearing older saved data on the **BD-LIVE™** storage device that is currently being used (page 17). If the internal memory of your **BluTechVision 3D** is insufficient, you can also connect an external USB storage medium with >1GB free memory.

Select the die **BD-LIVE™** function in the Disc Menu of the Blu-ray Disc™.

The player establishes an Internet connection to the content provider and displays a selection menu. These menus have individual layouts, depending on the provider, and can contain diverse information and functions, e.g. trailers, games, up-to-date information etc.



▲ ▼ ◀ ▶ Select menu item.

Press **OK** to confirm.



It may be possible to select menu functions with the coloured buttons.

The selected media are loaded (this can take several minutes depending on the speed of the Internet connection) and a prompt to play or start the function appears.

i Do not remove a connected external USB stick while data is being transferred.



Press **Stop** twice to quit **BD-LIVE™**.

With **BluTechVision 3D** you can play digital media files that are saved on USB storage media or on your home network.

Main Menu

HOME Call up the Main Menu.

In the Main Menu you can select the desired operating mode **Movie**, **Music**, **Photo** or **YouTube**.

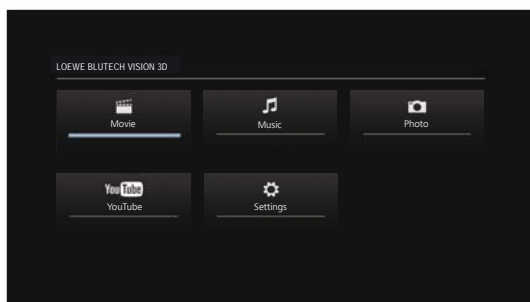

◀ ▶ ▲ ▼ Select desired operating mode.

Press **OK** to confirm.

If several media sources are available for the selected operating mode, a selection menu will appear.

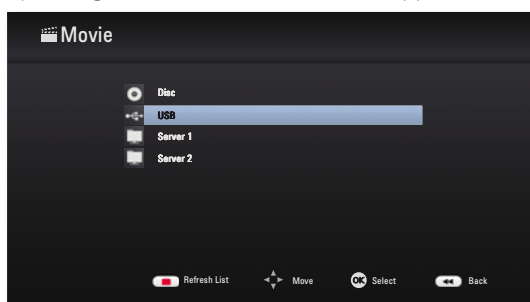

▲ ▼ Select the desired medium.

Press **OK** to confirm.

Video files

Playing video files

HOME Call up the Main Menu.



◀ ▶ ▲ ▼ Select the **Movie** option in the Main Menu.

Press **OK** to confirm.

If several media sources are available for the selected operating mode, a selection menu will appear.



▲ ▼ Select the desired medium.

Press **OK** to confirm.

◀ ▶ Select file or folder.

OK Start play or change to folder.



Play Start / Continue playback.

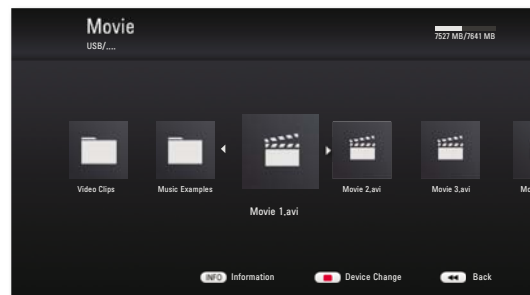

In the menu: One level back.



Red button Change device.

i For controlling the playback of media files see the chapter "Playback in general" (page 20).

Prerequisites for video files

- The maximum picture resolution of the video file is less than or equal to 1920 x 1080 (W x H) pixels.
- File name and path together shorter than 180 characters.
- Valid file endings for videos are: ".avi", ".divx", ".mpg", ".mpeg", ".mp4", ".mkv".
- Playable subtitle formats: SubRip (*.srt/* .txt), SAMI (*.smi), SubStation Alpha (*.ssa/* .txt), MicroDVD (*.sub/* .txt), SubViewer 2.0 (*.sub/* .txt), TMPlayer (*.txt), DVD subtitles (*.txt).
- Playable video codecs: "DivX3.11", "DivX4", "DivX5", "DivX6" (only standard playback)
- Playable video codecs: "Xvid.xx", "H.264/MPEG-4 AVC", "DIVX-HD", "MPEG2 PS", "MPEG2 TS".
- Playable audio codecs: "Dolby Digital" (AC3), "MP3", "DTS" (only on **SPDIF OUT**), "WMA", "AAC".
- Scanning frequency: MP3: 16 - 48 kHz, WMA: 32 - 48 kHz.
- Bit rates: MP3: 32 - 320 kbps, WMA: 32 - 192 kbps.
- If the video file and the subtitle have different file names, the subtitle might not be displayed when playing a DivX file.
- If the sound and image trace are not synchronous, either sound or pictures will be reproduced.
- HD movie files contained on CDs or USB 1.x memory sticks might not be played without fault, as the bandwidth for the data transfer is too low. Use Blu-ray™, DVD or USB 2.0 storage media instead.
- This device supports the H.264/MPEG-4 AVC - Main, High Level 4.1 Profile. A warning note will be displayed for media belonging to a profile above this.
- This device does not support the MPEG4/DivX6.xx functions GMC*1 (Global Motion Compensation) or Qpel*2 (Quarter pixel).

Music files

Playing music files



Call up the Main Menu.



◀ ▶ ▲ ▼ Select the **Music** option in the Main Menu.
 Press **OK** to confirm.

If several media sources are available for the selected operating mode, a selection menu will appear.



▲ ▼ Select the desired medium.
 Press **OK** to confirm.

◀ ▶ ▲ ▼ Select file or folder.

OK Start play or change to folder.



Play Start / Continue playback.

i For controlling the playback of media files see the chapter "Playback in general" (page 20).

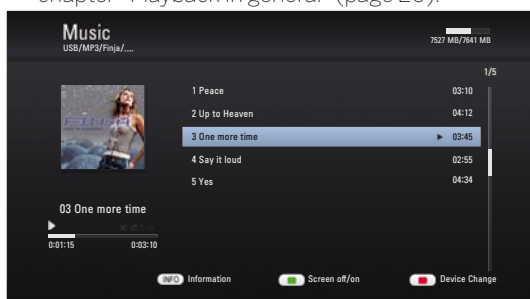

Select the type of repeat.



Green button: Screen On/Off

Red button Change device.

Prerequisites for music files

- Sampling frequency: 16- 48 kHz (MP3), 32 - 48 kHz (WMA).
- Bit rates: MP3: 32 - 320 kbps, WMA: 32 - 192 kbps.
- File extensions: ".mp3" / ".wma".
- CD/DVD/Blu-ray Disc™ format: ISO9660 / JOLIET / UDF (Bridge).
- ID3 tags are not supported by WMA.

USB Mode

- You can connect a USB storage medium directly to the USB socket.
- The standard USB 1.1 and 2.0 is supported.
- The USB device must not be disconnected during a data transfer.
- The file systems FAT16, FAT32 and NTFS are supported.
- The maximum number of files and folders is 2000. The search can take longer than 1 minute.
- Devices requiring an additional software installation for connection to a computer are not supported.
- USB connection options other than those indicated above are not supported.

Importing Audio CDs

You can convert the titles (tracks) on your audio CDs to digital music files and then access them easily with **BluTechVision**. The music files are saved on a connected USB storage medium.

Connect a USB storage medium with enough free memory space (page 8)

Insert the audio CD into the drive (page 19).

Start playing the disc (page 21).



Display Title Menu.

◀ ▶ Select the option **CD Recording**.

Press **OK** to confirm.

▲ ▼ Select the desired track.

Mark the selected track with **OK**

Mark any further tracks with **OK**

▶ Select the right menu.

▲ ▼ If necessary, select the bit rate in the **Options** Menu.

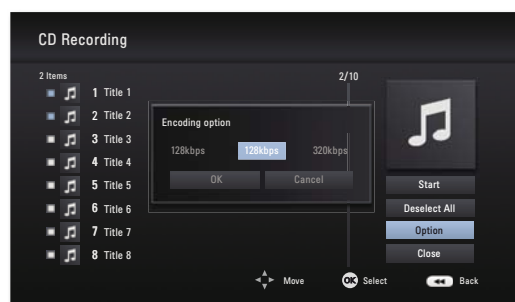

Start Selected tracks are converted

Select All All tracks of the CD are selected

Option You can set the bit rate (and the sound quality along with it)

Close Cancel procedure

◀ ▶ ▲ ▼ Select the option **Start**.

Press **OK** to confirm.

▲ ▼ Select a potential destination folder on the USB storage medium or create a new folder by using **New Folder**. You can name the new folder using the keypad that is shown.

▶ Select the option **OK** in the right-hand menu.

Press **OK** to confirm.

The conversion of the selected tracks now starts. The process lasts several minutes. The progress is displayed during this time.

A message is displayed after the process is completed.

Press **OK** to confirm.

The finished music files are located in a new folder on the USB storage medium, which has the name of the CD album.

i Do not disconnect the USB storage medium from the device until it is no longer being accessed.

i The music titles must be at least 20 seconds long.

Photo files

Display of photo files



Call up the Main Menu.



◀ ▶ ▲ ▼ Select the option **Photo**.

Press **OK** to confirm.

If several media sources are available for the selected operating mode, a selection menu will appear.

▲ ▼ Select the desired medium.

Press **OK** to confirm.

▲ ▼ ◀ ▶ Select file or folder.

OK Display photo or change to folder.

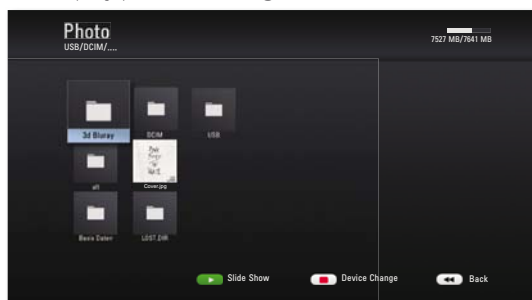

Slide Show

You can automatically display your photo files as a slide show.



Play Start / Continue slide show



Pause Stop slide show.



Stop Quit slide show/photo display/zoom mode.



Show/Hide Info Menu.

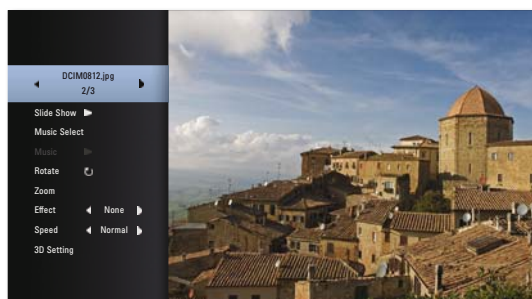

▲ ▼ ◀ ▶ Select/Set options.

Uppermost line Select a photo with ◀ ▶

Slide Show Pause/Play slide show with **OK**

Music Select Select music for the slide show

Music Pause/Play music with **OK**

Rotate Rotate image 90° to the right

Zoom Call up Zoom Mode with **OK** (page 22)

Effect Set transition effects

Speed Set display time

3D Setting 3D Mode for 2D images

Music Select

You can play music to accompany the slide show.

▲ ▼ ◀ ▶ Select the option **Music Select** in the Info Menu

Press **OK** to confirm.

◀ ▶ ▲ ▼ Select medium and **music album**.

i Folders containing music are marked with the symbol

▶ Select **OK** button.

Press **OK** to confirm.

If necessary, go to the Info Menu and start playback in the **Music** option with **OK**.

Prerequisites for photo files

- Max. pixel width: 4000 x 3000 pixels /24bit/pixel
- Max. pixel width: 3000 x 3000 pixels /32bit/pixel
- Max. file size 4 Mbyte
- The maximum number of files and folders is 2000. The search can take longer than 1 minute.
- File extensions: ".jpg", ".jpeg", ".png"
- Photo files that are compressed progressively or without loss cannot be displayed.

Setting the HDMI resolution

You can set up the video resolution of your **BluTechVision 3D** when using the **HDMI OUT** socket to adapt the image quality optimally for your TV set.

i End the playback until you see the main menu.



or press the **RES** button on the device

Each time you press , the resolution will be switched between 576p, 720p, 1080i and 1080p (one after another), as long as these resolutions are supported by the TV set connected.

YouTube videos

Playback of YouTube videos



Call up the Main Menu.



◀ ▶ Select the option **YouTube**.

Press **OK** to confirm.

The **YouTube** Menu is displayed.

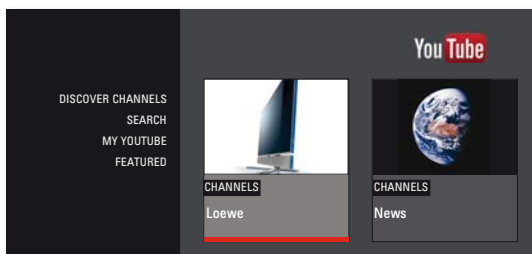

Discover Channels Search through YouTube channels

Search Input your own search term

My YouTube Log into YouTube

Featured View popular videos



▶ ▲ ▼ Select desired video.

i The selected video/element is marked by a red bar.

OK Start play.

Functions during playback

A menu appears for a short time after playback commences.

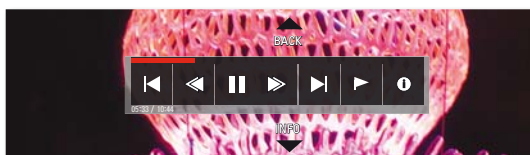

◀ ▶ ▲ ▼ Select the desired function

Press **OK** to confirm.



Jump to start or to the previous video / next video



10 seconds backwards / forwards



Pause / Resume play



Report video as inappropriate



Information on the video

Back

Back to the **YouTube** Menu



Rate the video positively



Rate the video negatively



Subscribe to the channel. By doing this, you will automatically be informed whenever this author uploads new videos.

OK Show the menu again.

Search for YouTube videos



Call up the Main Menu.



◀ ▶ Select the option **YouTube**.

Press **OK** to confirm.

◀ ▶ Select the option **Search**.

Press **OK** to confirm.

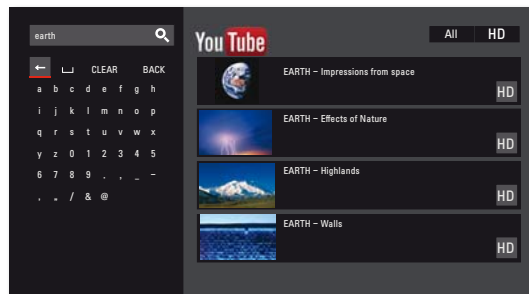

The **YouTube - Search** Menu is displayed.



▲ ▼ ◀ ▶ Select characters,

OK Insert the selected character.



Clear a character



Insert space



Clear all entries



Close the **Search** Menu

After you have entered a search term, videos that match it will be displayed automatically in the right-hand part of the menu.



▶ ▲ ▼ Select desired video.

i The selected video / element is marked by a red bar.

OK Start play.

i To be able to use personalised YouTube functions (i.e. channel subscription), you must have a YouTube account and the log-in information for it (username / password). You can register on the Internet at: www.youtube.com

i If the video playback does not run smoothly, the internet connection may not have sufficient bandwidth. Wait until the video has been completely loaded and then continue playback.

i Not all videos are available in all regions; this is due to copyright restrictions.

i As is the case for many internet services, the manufacturer cannot guarantee the availability and playback of YouTube videos.

Problem:	Possible cause	Remedy
Not working at all.	Mains cable not plugged in.	Plug the mains cable into a socket 220-240 V 50/60 Hz.
No picture	The device is not connected correctly.	Make the connections as described on page 9.
	The TV set is not set for the reception of DVD signals.	Select the correct AV programme slot on the TV set.
	The video cable is not connected correctly.	Check the two plugs of the cable for firm fitting in the sockets.
	The video resolution is incorrectly set.	Keep the STOP button pressed down for 5 seconds. The video resolution is reset to 576p.
No sound.	Faulty connections of input or output cables.	Connect the cable correctly (page 9). If the problem persists, it is possible that the cables are faulty.
	The volume is set at minimum.	Turn up the volume.
	The sound is set to mute.	Press  or V + on the remote control to reactivate the audio output and then set the volume level.
Playback not possible.	No disc inserted.	Insert a disc.
	A disc that cannot be played has been inserted.	Insert a playable disc. (Check the disc type, the colour system and the regional code).
	The disc is dirty.	Clean the disc.
	The disc is not inserted with the playback side downwards.	Insert the disc with the playback side facing downwards.
	The disc has not been placed in the guide.	Place the disc correctly inside the guide in the disc compartment.
A media file that is displayed cannot be played back.	The file format is not supported.	Convert the file to a supported format on a computer with a converter program.
The BD-LIVE™ function is not working properly.	The internal memory is not sufficient.	Clear the internal memory (page 17) or connect an external USB stick (>1 GB).
	The Internet connection is not working properly.	Set up the Internet connection as described from page 16 and make sure that you have a broadband connection.
	BD-LIVE™ is deactivated.	Activate the BD-LIVE™ function (page 16).
The unit is not working properly.		Unplug the mains plug from the mains socket and then try plugging it in again after 30 seconds.
	The software of your Loewe TV set is not compatible with BluTechVision 3D.	Please contact your dealer.
The remote control is not working properly.	The batteries in the remote control are dead.	Replace the batteries with new ones.

24p Cinema movie viewing: Today's movie makers shoot their movies with 24 images per second (24p); conventional televisions (and also most DVDs) show 50 images per second (50 Hz). In order to play the movie, the original number of images is doubled and the movie accelerated. That is optimum for sports broadcasts, but it distorts the picture quality for calmer movies. The new Loewe TV sets automatically reproduce 24p movies in the original 24p format.

B

Blu-ray Disc™: (BD) Disc format for recording/playing high-resolution video material (HD) for HDTV devices and for saving large volumes of data.

BD-LIVE™: Extra service offered by some Blu-ray Disc™ providers. Current trailers, additional information as well as interactive media and applications (e.g. games) can be loaded via a broadband Internet connection with this.

BD-J: The BD-ROM format supports the programming language Java for interactive functions. "BD-J" gives content providers a greater variety of functions when creating interactive BD-ROM titles.

BD-ROM: BD-ROM discs allows up to 25 GB (single layer) or 50 GB (dual layer) of data to be saved in a single disc.

C

CEC: Abbreviation for Consumer Electronics Control. CEC makes overall component control functions available for consumer electronics devices (e.g. System Standby, One Touch Play). CEC is referred to by Loewe as Digital Link HD.

D

Digital Link HD: System for controlling units via the HDMI connection of the Loewe TV set when they have been set up in a covered position.

Dolby Digital: Digital multi-channel sound.

Dolby Pro Logic: Analogue multi-channel sound.

DHCP: Abbreviation for Dynamic Host Configuration Protocol. DHCP permits automatic assignment of IP addresses with the aid of a DHCP server.

DHCP server: Network service which takes care of automatic assignment of IP addresses to clients.

DRM: Digital Rights Management. Processes to control copyright protected data. To be used correctly, DRM protected contents require not only a DRM capable device but also the possession of a license issued by the provider (to be paid for).

DTS: Digital multi-channel sound.

DVD: Abbreviation for Digital Video Disc and later Digital Versatile Disc.

H

HDMI: High Definition Multimedia Interface - represents a newly developed interface for the fully digital transfer of audio and video files.

HDTV (HD): High Definition Television is a collective term, designating a series of high-resolution television standards.

I

Interlaced Mode: Technology for image formation in interlaced scanning for flicker-free reproduction of frames with double frame rate.

IP Address: IP addresses (Internet Protocol Addresses) are used to identify devices in an Internet Protocol (IP) network. IP addresses are made up of four number ensembles that are made up of three digits each.

J

JPEG/JPG: Joint Photographic Experts Group is a committee, which has developed a standardised method for the compression of digital images. This JPEG method (in short JPG), named after the committee, is an international graphics format for photos.

L

LAN: Abbreviation for Local Area Network. Mainly used as a name for networks with cabling (Ethernet).

M

MPEG: Digital compression method for video.

MP3: Data format for compressed audio files.

P

PCM: Pulse Code Modulation for digital sound.

Progressive Mode: Technology for image formation with real full frames for flicker-free reproduction.

R

RGB: Colour signals Red, Green and Blue.

U

USB: Universal Serial Bus. Serial bus system for connecting external devices (USB card reader, USB stick).

W

WMA: Abbreviation for Windows Media Audio, Microsoft's own audio data format. As with MP3 files, the content is compressed here as well.

Y

YCbCr: digital colour model.

YPbPr: Analogue colour model.

YouTube: Videos and video clips that are stored on the internet.

Enter the corresponding code for the initial setting of "Disc Audio", "Disc Subtitle" and/or "Disc Menu" (page 11).

Afar	6565	Sanskrit	8365
Afrikaans	6570	Scottish (Gaelic)	7168
Albanian	8381	Swedish	8386
Amharic	6577	Serbian	8382
Arabic	6582	Serbo-Croatian	8372
Armenian	7289	Shona	8378
Azerbaijani	6590	Sindhi	8368
Assamese	6583	Sinhala	8373
Aymara	6588	Slovakian	8375
Bashkir	6665	Slovenian	8376
Basque	6985	Spanish	6983
Bengali, Bangla	6678	Sudanese	8385
Bhutanese	6890	Swahili	8387
Bihari	6672	Tajik	8471
Breton	6682	Tagalog	8476
Bulgarian	6671	Tamil	8465
Chinese	9072	Telugu	8469
Danish	6865	Thai	8472
German	6869	Tongalese	8479
English	6978	Czech	6783
Esperanto	6979	Turkish	8482
Estonian	6984	Turkmen	8475
Farose	7079	Twi	8487
Fiji	7074	Ukrainian	8575
Finnish	7073	Hungarian	7285
French	7082	Urdu	8582
Friesian	7089	Uzbek	8590
Galician	7176	Vietnamese	8673
Georgian	7565	Volapük	8679
Greek	6976	Welsh	6789
Greenlandic	7576	Belarusian	6669
Guarani	7178	Wolof	8779
Gujarati	7185	Xhosa	8872
Hausa	7265	Yoruba	8979
Hebrew	7387	Zulu	9085
Hindi	7273		
Indonesian	7378		
Interlingua	7365		
Irish	7165		
Icelandic	7383		
Italian	7384		
Javanese	7487		
Yiddish	7473		
Canadian	7578		
Kazakh	7575		
Kashmiri	7583		
Kirghiz	7589		
Korean	7579		
Croatian	7282		
Kurdish	7585		
Lao	7679		
Latin	7665		
Latvian	7686		
Lingala	7678		
Lithuanian	7684		
Malagasy	7771		
Malaysian	7783		
Malayalam	7776		
Maori	7773		
Marathi	7782		
Macedonian	7775		
Moldavian	7779		
Mongolian	7778		
Burmese	7789		
Nauru	7865		
Nepalese	7869		
Dutch	7876		
Norwegian	7879		
Oriya	7982		
Panjabi	8065		
Pashtu	8083		
Persian	7065		
Polish	8076		
Portuguese	8084		
Quechua	8185		
Rhaeto-Romance	8277		
Romanian	8279		
Russian	8285		
Samoaan	8377		

Enter the corresponding code for the initial setting of the "Area Code" (page 14).

Afghanistan	AF	Vietnam	VN
Egypt	EG	Zimbabwe	ZW
Antilles	AN		
Argentina	AR		
Ethiopia	ET		
Australia	AU		
Belgium	BE		
Bhutan	BT		
Bolivia	BO		
Brazil	BR		
Chile	CL		
China	CN		
Costa Rica	CR		
Denmark	DK		
Germany	DE		
Ecuador	EC		
El Salvador	SV		
Fiji	FJ		
Finland	FI		
France	FR		
Greece	GR		
Greenland	GL		
Great Britain	GB		
Hong Kong	HK		
India	IN		
Indonesia	ID		
Israel	IL		
Italy	IT		
Jamaica	JM		
Japan	JP		
Cambodia	KH		
Canada	CA		
Kenya	KE		
Columbia	CO		
Croatia	HR		
Kuwait	KW		
Libya	LY		
Luxembourg	LU		
Malaysia	MY		
Maldives	MV		
Morocco	MA		
Mexico	MX		
Monaco	MC		
Mongolia	MN		
Nepal	NP		
New Zealand	NZ		
Netherlands	NL		
Nigeria	NG		
Norway	NO		
Oman	OM		
Austria	AT		
Pakistan	PK		
Panama	PA		
Paraguay	PY		
Philippines	PH		
Poland	PL		
Portugal	PT		
Czech Republic	CZ		
Republic of Congo	CG		
Slovakia	SK		
Romanian	RO		
Russian Federation	RU		
Saudi Arabia	SA		
Sweden	SE		
Switzerland	CH		
Senegal	SN		
Zimbabwe	ZW		
Singapore	SG		
Slovenia	SI		
Spain	ES		
Sri Lanka	LK		
South Africa	ZA		
South Korea	KR		
Taiwan	TW		
Thailand	TH		
Turkey	TR		
Uganda	UG		
Ukraine	UA		
Hungary	HU		
Uruguay	UY		
USA	US		
Uzbekistan	UZ		

Technical Data

General

BluTechVision 3D	art. no. 53504 L/T/U
Operating temperature	5 °C ... 35 °C
Humidity	30 % ... 85 % (no condensation)
Dimensions (approx.)	430 x 62,5 x 272 mm (W x H x D)
Weight	2.5 kg

Electrical data

Power supply:	AC 200 - 240V, 50/60 Hz
Power consumption	Operation: 17 W Standby: 0.5 W
Laser	Laser class 1, wavelength: 405nm/650nm
Memory for BD-LIVE™	1 GByte

Interfaces

AUDIO OUT	Analogue, Stereo, 2 V, 600 Ohm, RCA socket x 2
SPDIF OUT	0.5 V (p-p), 75 Ohm, 44.1 kHz, RCA socket
HDMI	Type A, 19 pin, TMDS digital, V1.4
USB	V 2.0, Type A, DC 5 V, 500 mA
LAN	Wired network RJ-45

Play

Playback formats	Blu-ray Disc™, Blu-ray 3D™ DVD-Video, DVD+/-R, DVD+/-RW (Video Mode) CD, CD-R, CD-RW
Video standards	TV standard PAL / NTSC TV Aspect Ratio 16:9, Letterbox 4:3, Panscan 4:3
Audio standards	Dolby Digital (AC-3), DTS, MPEG, PCM
Frequency range	20 Hz to 20 kHz (48 kHz-, 96 kHz-, 192 kHz- Sampling)
Signal-to-noise ratio	> 85 dB (AUDIO OUT)
Dynamic scope (1 kHz)	> 85 dB (DVD/Blu-ray Disc™)
Harmonic distortions	< 0.02 % (DVD/Blu-ray Disc™)

File formats supported

Audio	MP3, WMA, M4A (without DRM)
Photo	JPEG, PNG
Video	AVI, MKV, MP4, DivX, WMV

Home networking standard

Audio, Photo, Video	DLNA
---------------------	------

Wired network

Standards supported	10 Mbit/s Ethernet (10Base-T), 100 Mbit/s Fast Ethernet (100Base-T)
---------------------	---

Wireless network

Supported standards	801.11b/g/n (2.4GHz)
---------------------	----------------------

Design and technical specifications are subject to change without notice.

 The code number **210499** cancels the password and hence the lock. Please keep it in a safe place.

Trademarks

Blu-ray Disc™, Blu-ray™, Blu-ray 3D™, BD-Live™, BONUSVIEW™ as well as the logos and brands are trademarks of the Blu-ray Disc Association.
ABOUT DIVX VIDEO: DivX® is a digital video format created by DivX, LLC, a subsidiary of Rovi Corporation. This is an official DivX Certified® device that has passed rigorous testing to verify that it plays DivX video. Visit divx.com for more information and software tools to convert your files into DivX videos.
ABOUT DIVX VIDEO-ON-DEMAND: This DivX Certified® device must be registered in order to play purchased DivX Video-on-Demand (VOD) movies. To obtain your registration code, locate the DivX VOD section in your device setup menu. Go to vod.divx.com for more information on how to complete your registration.
DivX®, DivX Certified® and associated logos are trademarks of Rovi Corporation or its subsidiaries and are used under license.
HDMI, the HDMI logo and High-Definition Multimedia Interface are trademarks or registered trademarks of HDMI Licensing LLC.
Manufactured under licence from Dolby Laboratories. Dolby, ProLogic and the double-D symbol are trademarks of Dolby Laboratories.
Manufactured under license under U.S. patents: 5,451,942; 5,956,674; 5,974,380; 5,978,762; 6,226,616; 6,487,535; 7,212,872; 7,333,929; 7,392,195; 7,272,567 and further US and international patents issued and filed. DTS and the symbol are registered trademarks, & DTS-HD, DTS-HD Master Audio and the DTS logos are trademarks of DTS, Inc. This product contains software.
© DTS, Inc. All rights reserved.
"AVCHD" and the "AVCHD" logo are trademarks of Panasonic Corporation and Sony Corporation.
Java and all Java-based trademarks and logos are trademarks or registered trademarks of Sun Microsystems, Inc. in the United States and in other countries.



This product contains software which has been developed by third parties and/or software covered by the GNU General Public License (GPL) and/or the GNU Lesser General Public License (LGPL) and/or other open source licenses.

The publication of this program by Loewe is carried out WITHOUT ANY GUARANTEE OR SUPPORT, particularly without an implicit guarantee concerning MARKET MATURITY or the USABILITY FOR A SPECIFIC PURPOSE. Details can be found in the GNU General Public License. You can obtain the software via the Loewe customer service department. The GNU General Public License can be downloaded from: <http://www.gnu.org/licenses/>.

Cinavia note

This product uses Cinavia technology to reduce the usage of unauthorised copies of commercial movie and video products and their soundtracks.

If prohibited use of an unauthorised copy is detected, a message to this effect will appear and the playback or the copy process will be interrupted.

Further information on Cinavia technology is provided in the Cinavia online consumer information centre at <http://www.cinavia.com>.

To request further information on Cinavia by post, send a postcard with your address to Cinavia Consumer Information Center, P.O. Box 86851, San Diego, CA, 92138, USA.

This product consists of protected technology under licence of the Verance Corporation and is protected by the U.S. patent 7,369,677 as well as by other U.S./world-wide granted and pending patents. It is also protected by copyright and certain aspects of this technology are subject to trade secrecy. Cinavia is a trademark of the Verance Corporation.

Copyright 2004-2010 Verance Corporation. Verance reserves all rights.

Reverse engineering or disassembly is prohibited.

DLNA®, the DLNA Logo and DLNA CERTIFIED® are trademarks, service marks or seals of quality from the Digital Living Network Alliance.

The WiFi certified logo is a seal of quality from the WiFi alliance.

YouTube™ and the YouTube logo are trademarks and / or registered trademarks of Google Inc.

Gracenote® End User License Agreement

This application or device contains software of Gracenote, Inc., with head office in Emeryville, California, USA (hereinafter referred to as "Gracenote").

The software provided by Gracenote ("Gracenote software") enables this application to identify music albums and/or files online and access music-related data from online servers or integral databases (summarised under the designation "Gracenote servers"), including information on the name, artist, track and title ("Gracenote data"), as well as execute further functions. You may only use the Gracenote data as intended for the end user functions of the application or device. You hereby assure that you shall only utilise Gracenote data, the Gracenote software and the Gracenote servers for your personal and non-commercial use. You assure that you shall not make the Gracenote software or any Gracenote data available to third parties, copy such for third parties or transfer or send such to third parties. YOU HEREBY ASSURE THAT YOU SHALL ONLY UTILISE GRACENOTE DATA, THE GRACENOTE SOFTWARE AND GRACENOTE SERVERS AS EXPRESSLY PERMITTED IN THIS DOCUMENT.

You hereby accept that your non-exclusive licence for the use of Gracenote data, the Gracenote software and the Gracenote servers shall expire if you violate the above restrictions. You assure that you shall cease to use the Gracenote data, the Gracenote software and Gracenote servers in any way whatsoever after expiry of your licence. Gracenote reserves all rights to Gracenote data, the Gracenote software and the Gracenote servers, in particular all rights of ownership. On no account is Gracenote obliged to make payments to you for information which you make available to Gracenote. You accept that Gracenote, Inc., may enforce its rights resulting from this agreement directly and on its own behalf against you. The Gracenote service uses a special identification mechanism to record enquiries for statistical purposes. This randomly assigned numerical identification serves to enable the Gracenote service to count queries, without data about you being revealed.

You shall receive a licence for the Gracenote software and all Gracenote data as issued. Gracenote does not make any explicit or implicit statements or promises in respect to the correctness of the Gracenote data on the Gracenote servers. Gracenote reserves the right to clear data from the Gracenote servers or change data categories for reasons that are reasonable in the opinion of Gracenote. Gracenote does not provide any assurance that the Gracenote software or the Gracenote servers are fault-free or that the Gracenote software and the Gracenote-Server will function without interruption. Gracenote is not obliged to provide you with new, improved or additional data types or categories which Gracenote might offer in the future, and Gracenote is entitled to stop its services at any time.

GRACENOTE EXCLUDES ALL EXPRESS OR IMPLICIT GUARANTEES, IN PARTICULAR IMPLICIT GUARANTEES CONCERNING STANDARD QUALITY, SUITABILITY FOR A DEFINITE PURPOSE, OWNERSHIP AND THE NON-VIOLATION OF RIGHTS. GRACENOTE DOES NOT PROVIDE ANY GUARANTEE FOR THE RESULTS YOU ATTAIN THROUGH USING THE GRACENOTE SOFTWARE OR FROM GRACENOTE SERVERS. GRACENOTE IS ON NO ACCOUNT LIABLE FOR CONSEQUENTIAL OR ACCIDENTAL DAMAGE, FOR LOST PROFIT OR LOST REVENUE.

© Gracenote, Inc. 2009



Declaration of conformity

This equipment is in compliance with the essential requirements and other relevant provisions of **Directive 1999/5/EC**. It may be operated in all countries in the **EU** and also in **Iceland, Norway and Switzerland**.

The set is CE marked and complies with EU directives. The complete Declaration of conformity can be downloaded from our website.

CE 0984

AUS
Qualifi Pty Ltd
24 Lionel Road
Mt.Waverley VIC 3149 Australia
Tel +61-03-8542 1111
Fax +61-03-9543 3677
E-mail: info@qualifi.com.au

B NL L
Loewe Opta Benelux NV/SA
Uilenbaan 84
2160 Wommelgem, België
Tel +32 - 3 - 2 70 99 30
Fax +32 - 3 - 2 71 01 08
E-mail: ccc@loewe.be

CH
Telion AG
Rütistrasse 26
8952 Schlieren, Schweiz
Tel +41 - 44 732 15 11
Fax +41 - 44 732 15 02
E-mail: infoKD@telion.ch

CN
Guangdong MG Audio Development Co.Ltd
No.8 Jinghu Rd. Xinhua St. Huadu Reg.
GZ, PRC
Tel +86-(0)20-22675666
Fax +86-(0)20-22675777
E-mail: service@loewe-mg.com

Xiamen Tenote Investment Co. Ltd
26F 3# Xinglin Bay Operation Center,
No.478 xinglinwan Avenue,
Jimei District, Xiamen, Fujian, PRC
Tel +86-400 088 1566
E-mail: service@loewe-tnt.com

CY
Hadjikyriakos & Sons Ltd.
121 Prodromos Str., P.O Box 21587
1511 Nicosia, Cyprus
Tel +357 - 22 87 21 11
Fax +357 - 22 66 33 91
E-mail: savvas@hadjikyriakos.com.cy

CZ
BaSys CS s.r.o.
Sodomkova 1478/8
10200 Praha 10 - Hostivar,
Česká republika
Tel +420 234 706 700
Fax +420 234 706 701
E-mail: office@basys.cz

D A
Loewe Technologies GmbH,
Customer Care Center
Industriestraße 11
96317 Kronach, Deutschland
Tel +49 9261 99-500
Fax +49 9261 99-515
E-mail: ccc@loewe.de

DK
EET Europarts
Loewe Denmark
Bregnerødvej 133 D
3460 Birkerød, Denmark
Tel +45 - 82 19 19
E-mail: info@eeteuroparts.dk

E
Gaplasa S.A.
Conde de Torroja, 25
28022 Madrid, España
Tel +34 - 917 48 29 60
Fax +34 - 913 29 16 75
E-mail: loewe@maygap.com

F
Loewe France SAS
Rue du Dépôt,
13 Parc de l'Europe, BP 10010
67014 Strasbourg Cédex, France
Tel +33 - 3 - 88 79 72 50
Fax +33 - 3 - 88 79 72 59
E-mail: loewe.france@loewe-fr.com

FIN
EET Europarts
Loewe Finland
Metsänneidonkuja 12
02130 Espoo, Finland
Tel +358 9 47 850 900
www.eeteuroparts.fi

GB IRL
Loewe UK Limited
1st Floor, 237A Kensington High St
London
W8 6SA, UK
Tel +44 - (0) 207 368 1100
Fax +44 - (0) 207 368 1101
E-mail: enquiries@loewe-uk.com

GR RO AL
Issagogiki Emboriki Ellados S.A.
321 Mesogion Av.
152 31 Chalandri-Athens, Hellas
Tel +30 - 210 672 12 00
Fax +30 - 210 674 02 04
E-mail: christina_argyropoulou@
isembel.gr

HR
Plug&Play Ltd.
Bednjanska 8, 10000 Zagreb
Hrvatska (Kroatia)
Tel +385 1 4929 683
Fax +385 1 4929 682
E-mail: info@loewe.hr

I
Loewe Italiana S.r.L.
Via Monte Baldo, 14/P - 14/N
37069 Dossobuono di Villafranca di
Verona
Tel +39 - 045 82 51 690
Fax +39 - 045 82 51 622
E-mail: info@loewe.it

IL
Clear electronic entertainment Ltd
13 Noah Mozes St.
Agish Ravad Building
Tel Aviv 67442, Israel
Tel +972 - 3 - 6091100
Fax +972 - 3 - 6092200
E-mail: info@loewe.co.il

IND
Nonplus Ultra Home Automation Pvt Ltd
First Floor, No. 615, Second Main Road
Indiranagar Stage I, Indiranagar
Bangalore 560038
India
Tel +91 80 41114599
E-mail: jimmy@nplusultra.in

IR
Pars Royal Taramesh
LOEWE Gallery
#3 Shariati St. Opp. Soheil St.
P.O.Box 1914965537
Tehran, Iran
Tel + 98 21-22391661
E-Mail: info@tarameshgroup.com

JOR
ACCU-TECH Solutions Co.
1-Kharija Al-Ashja'i Street
Jabal Al-Weibdeh
P.O.Box 9668 Amman 11191, Jordan
Tel: +962-6-465-9985
Fax: +962-6-465-0119
E-Mail: info@accutech-solutions.net

KSA
LOEWE Show Room
Olaya Street, Near Kingdom Center
RIYADH, SAUDI ARABIA
P.O.Box 92831 Riyadh 11663
Tel +966-11-4640927
Fax +966-11-4640759
E-mail: hkkurkjian@gmail.com

LV EST
Kpartners, SIA
A. Čaka iela 80
Rīga, LV-1011, Latvia
Tel +3 71 - 67 29 29 59
Fax +3 71 - 67 31 05 68
E-mail: evgenii.bebnev@loewe.lv

LT
A Cappella Ltd.
Ausros Vartu 5, Pasazo skg.
01129 Vilnius, Lithuania
Tel +370 - 52 12 22 96
Fax +370 - 52 62 66 81
E-mail: info@loewe.lt

N
EET Europarts AS
Olaf Helsetsvei 6 (Vekstsenteret)
0694 Oslo, Norge
Tel +47 - 22919500
E-mail: salg@eeteuroparts.no

P
Gaplasa S.A.
Rua Professor Henrique de Barros
Edifício Sagres, 2º. C
2685-338 Prior Velho, Portugal
Tel +351 - 21 942 78 30
Fax +351 - 21 940 00 78
E-mail: geral.loewe@mayro.pt

PL
3LOGIC Sp.z o.o.
ul. Zakopiańska 153
30-435 Kraków
Tel +48 - 12 640 20 00
Fax +48 - 12 640 20 01
www.3logic.pl

RI
V2 Indonesia
5th Intilazeh tower
Jl. Jenderal Sudirman 32
Jakarta 10220, INDONESIA
Tel +62-21 57853547
E-mail: service@v2indonesia.com

RL
I Control SAL
Gemmaizeh, Rmeil.
Building 328 1st Floor Beirut, Lebanon
Tel +961 1 446777 / 1 587446
Fax +961 1 582446
E-mail: info@icontrol-leb.com

RUS
Service Center Loewe
Aptekarsky per.4 podjezd 5A
105005 Moscow, Russia
Tel +7 - 499 940 42 32 (ext. 454)
Fax +7 - 495 730 78 01
E-mail: service@loewe-cis.ru

S
EET Europarts AB
Loewe Sweden
Box 4124
SE-131 04, Nacka, Sverige
Tel +46 - 8 507 510 00
E-mail: Kundservice@eeteuroparts.se

SGP
Atlas Care Centre
11 changi south street 3
#03-01 builders centre
Singapore 486122
Tel +65 - 6745 2028
Fax +65 - 6546 7861
E-mail: service@atlas-sv.com

TR
ENKAY GROUP
SERVISPLUS MUSTERI HIZMETLERI
Alemdag Cad. Site Yolu No:18
Umraniye, Istanbul, TÜRKIYE
Tel 444 4 784
E-mail: info@servisplus.com.tr

ZA
Volco Enterprise Close Corporation
Unit 8
7 on Mastiff (Road)
Longlake Ext 1, Lingbro Business Park
2165 Johannesburg
Tel +27 11 608 1228
Fax +27 11 608 1740
E-mail: v63@mweb.co.za

