

---

# Audiodesign

Loewe Sound Projector ID



Operating instructions

---

**LOEWE.**

34073021

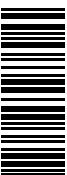

# Quick Guide: Sound Projector

## Preparation

TV operation remote control 

Remote Control **Sound Projector** 

Switch device on/off 

## Set Menu

Menu selection  **OK**

Settings Menu 

Hide Menu 

Select signal source  / **Source**

## Audio Functions

Volume **V+/-**

Sound on / Mute 

Surround mode 

Sound mode 

Decoder mode 

Bass mode 

5.1/7.1-channel mode 

Sound Menu 

Dual Mono 

Sound field programme **MUSIC** 

Sound field programme **MOVIE** 

Sound field programme **SHOW** 

Sound field programme **OFF** 

Listening position 

## Radio

**Sound Projector** FM Radio  (press and hold)

Next/Previous Radio Station **P+/-**

Search run forwards  (press and hold)

Search run backwards  (press and hold)

Fine-tuning forwards 

Fine-tuning backwards 

RDS display 

# Remote Control Assist – Sound Projector Operation

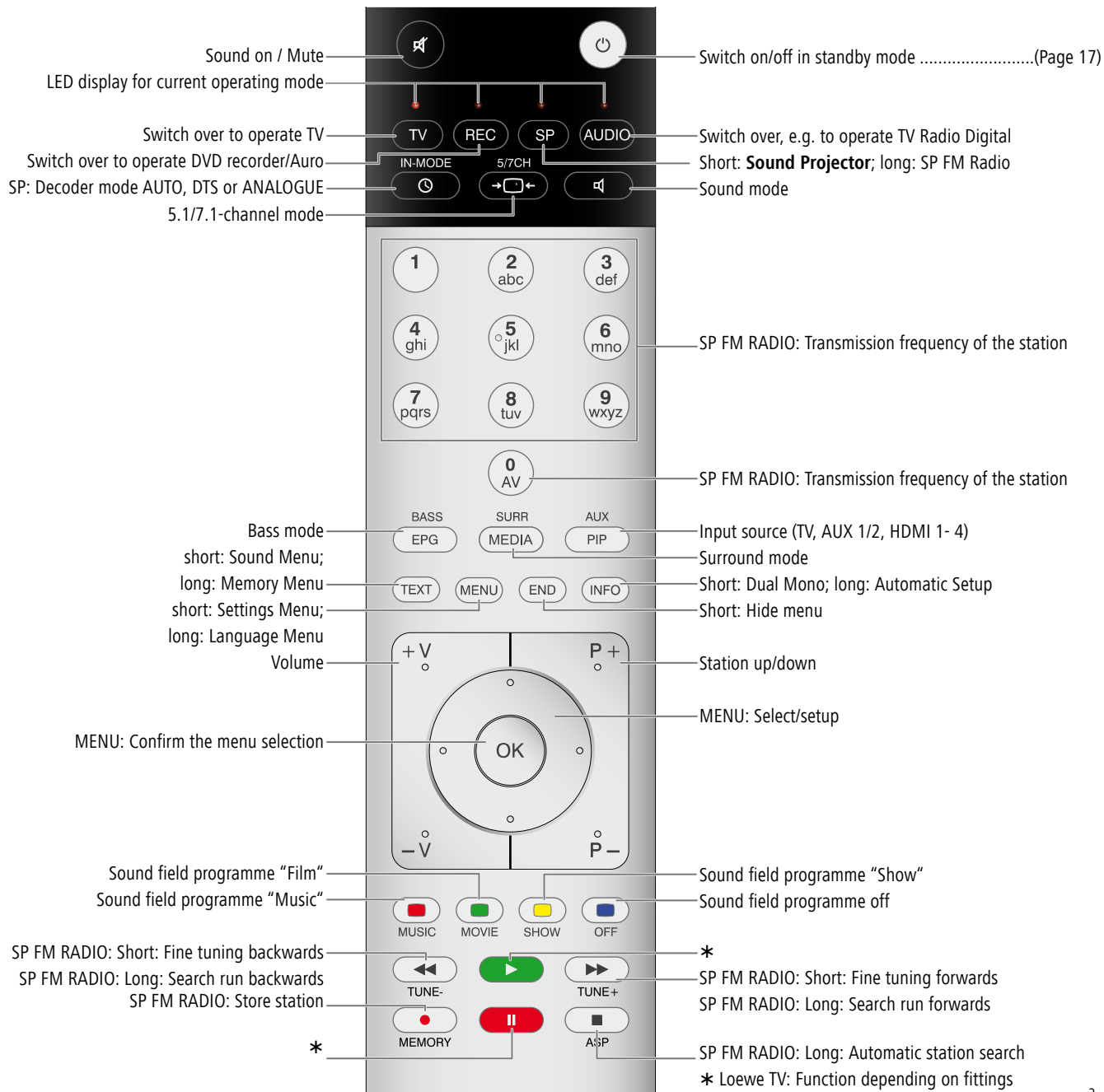

# Index of key words

## **Symbols**

5.1/7.1-channel mode 27

## **A**

Accessories 8

Acoustic room set-up 18

Adjusting volume 23

Audio delay 28

## **B**

Back 7

Bass mode 27

Batteries 35

## **C**

Cleaning 9

Company and editorial details 34

Composite system 13

Connections 30

Connect the microphone 18

## **D**

Decoder mode 25

Device buttons 16

Display 6, 30

Disposal 35

DRC 28

Dynamic range-control 28

Dynamics range 28

## **E**

Environment 35

Error messages 32

## **F**

Factory settings 16

Front View 6

## **G**

Getting Started 2

## **I**

Intended Use 9

## **L**

Legal notices 35

Listening position 23

## **M**

Mains supply 17

## **O**

Operating Loewe Equipment 16

## **P**

Performance 10

Playback 23

Positioning in the room 11

## **R**

Radio 29

REC button 16

Remote Control 3, 16

## **S**

Safety 9

Scope of delivery 8

Service 36

Setting up 8

Setting up the Assist Remote Control 16

Set-up solutions 12

Sound field programmes 26

Sound functions 16

Sound menu functions 28

Sound mode 24

Sound via 28

Speakers 30

Subwoofer 28

Supervision 9

Switching on/off 16, 17

Swivel castor control 23

## **T**

Technical Data 33, 34

Tone control 28

Trademark rights 35

Troubleshooting 30

TV button 16

# Contents

|   |           |
|---|-----------|
| <b>Quick Guide: Sound Projector</b> .....   | <b>2</b>  |
| <b>Remote Control Assist – Sound Projector Operation</b> .....                                | <b>3</b>  |
| <b>Front View &amp; Display</b> .....   | <b>6</b>  |
| <b>Back</b> .....   | <b>7</b>  |
| <b>Welcome</b> .....  | <b>8</b>  |
| Scope of delivery.....  | 8         |
| Accessories.....  | 8         |
| Set-up in general.....  | 8         |
| For your safety .....   | 9         |
| About these operating instructions .....  | 9         |
| <b>Performance</b> .....  | <b>10</b> |
| <b>Setting up</b> .....   | <b>11</b> |
| Setup.....  | 11        |
| Positioning in the room.....  | 11        |
| Set-up solutions .....  | 12        |
| Connecting the Sound Projector.....   | 12        |
| <b>Connecting</b> .....   | <b>13</b> |
| Sound Projector in the Loewe TV Composite System .....  | 13        |
| Sound Projector and Mediacenter in the Loewe TV Composite System.....                         | 14        |
| Connecting to Loewe TV sets <u>without</u><br>RJ-12/RS-232C system interface .....            | 15        |
| <b>Start-up</b> .....   | <b>16</b> |
| Using the remote control for the first time .....   | 16        |
| Setting up the Assist Remote Control .....  | 16        |
| Operating Loewe Equipment.....  | 16        |
| Connecting to the Mains Supply .....  | 17        |
| Switching on/off.....   | 17        |
| Acoustic room set-up .....  | 18        |
| Connecting and setting up the microphone.....   | 18        |
| Auto setup (TV sets <u>with</u> RJ-12/RS-232C System interface).....                          | 19        |
| Auto setup (TV sets <u>without</u> RJ-12/RS-232C System interface).....                       | 21        |
| <b>Everyday Use</b> .....   | <b>23</b> |
| Playback.....   | 23        |
| Loading listening position.....   | 23        |
| Select sound mode .....   | 24        |
| Select decoder mode .....   | 25        |
| Playback of 2-channel signal sources with surround sound .....                                | 25        |
| Sound field programmes .....  | 26        |
| 5.1/7.1-channel mode .....  | 27        |
| Bass mode.....  | 27        |
| Sound menu functions for Loewe TV sets <u>with</u> RJ-12/RS-232C System Interface             | 28        |
| Sound menu functions for Loewe TV sets <u>without</u> RJ-12/RS-232C System<br>Interface ..... | 28        |
| Radio Setup.....  | 29        |
| Radio Operation.....  | 29        |
| <b>Other settings</b> .....   | <b>30</b> |
| Loudspeakers.....   | 30        |
| Connections .....   | 30        |
| Display .....   | 30        |
| <b>Troubleshooting</b> .....  | <b>31</b> |
| Error messages for auto set-up.....   | 32        |
| <b>Glossary</b> .....   | <b>33</b> |
| <b>Technical Data</b> .....   | <b>34</b> |
| Company and editorial details.....  | 34        |
| <b>Environment</b> .....  | <b>35</b> |
| Environmental Protection .....  | 35        |
| <b>Legal notices</b> .....  | <b>35</b> |
| <b>Trademark rights</b> .....   | <b>35</b> |
| <b>Service</b> .....  | <b>36</b> |

# Front View & Display

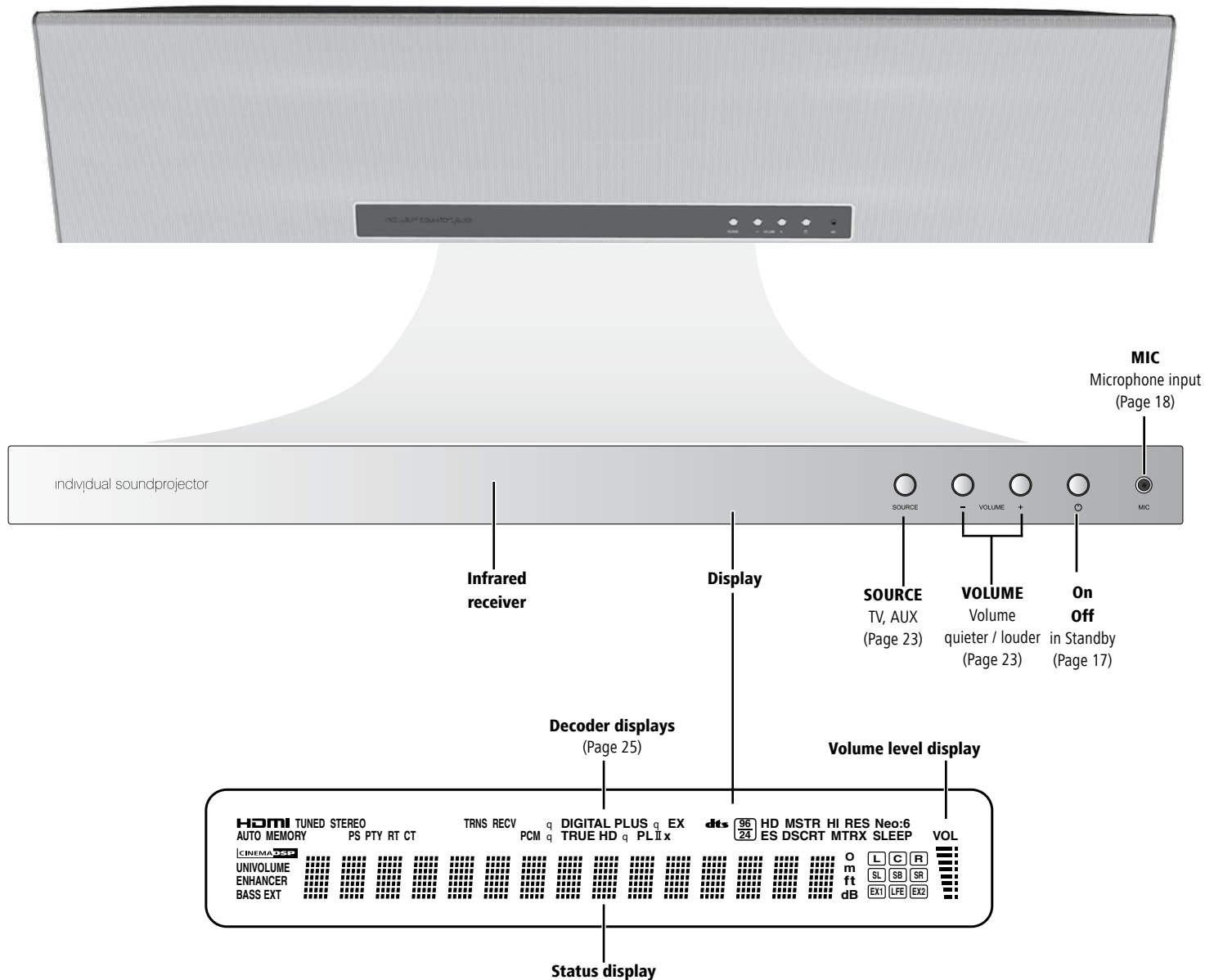

# Back

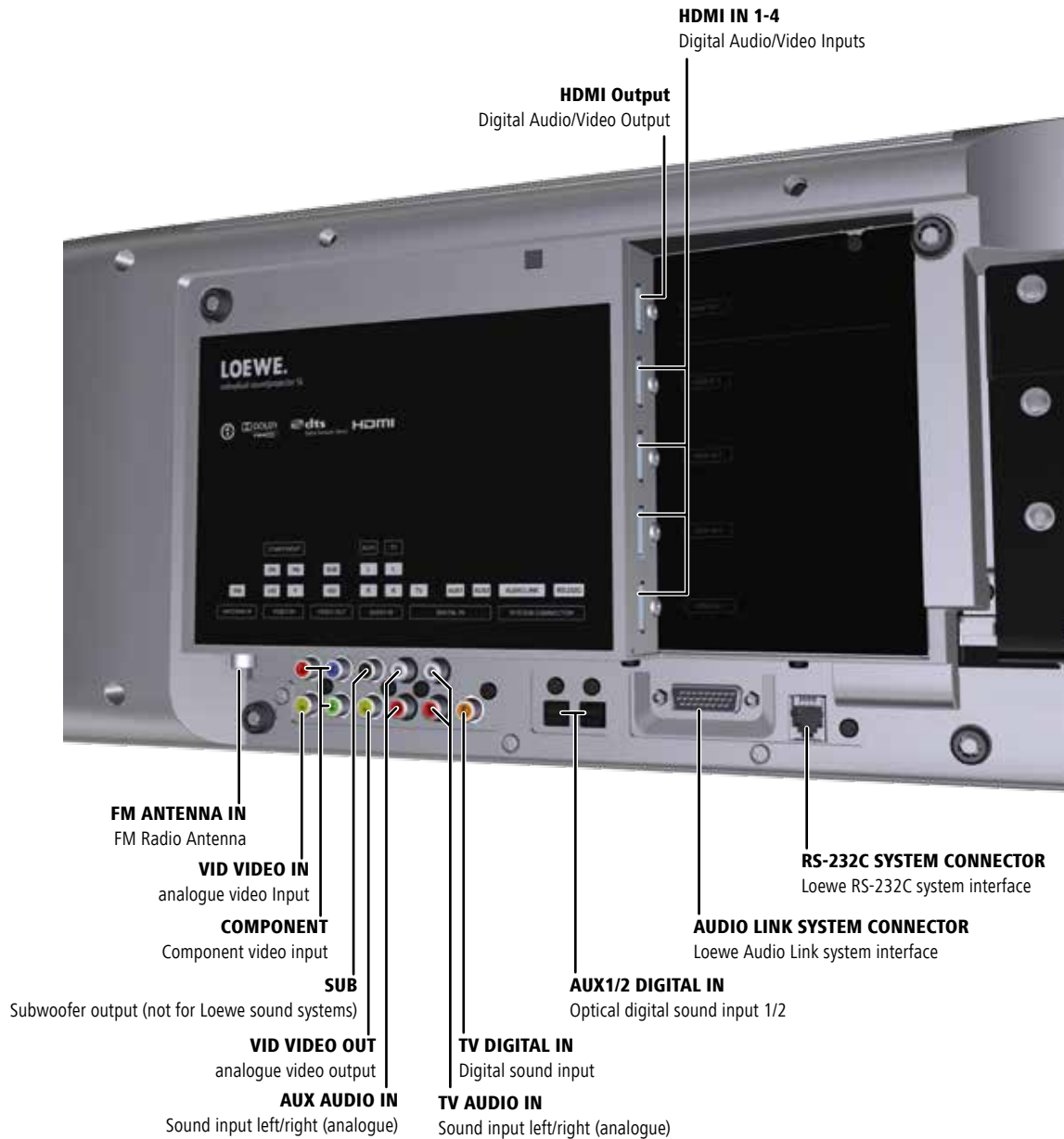

# Welcome

## Thank you

for choosing a Loewe product. We are happy to welcome you as our customer. At Loewe, we combine the highest standards of technology, design and user-friendliness. This is equally true of TV, DVD, video, audio and accessories. Neither technology nor design is an end in itself, but both are intended to provide our customers with the best possible audio and visual experience. Our design is not influenced by short-term, fashionable trends. You have, after all, purchased a high-quality piece of equipment which you do not want to tire of tomorrow or the day after.

## Scope of delivery

- Loewe Sound Projector ID
- Remote Control Assist with 2 batteries
- Wall mount
- Antenna cable
- HDMI cable
- Mains cable
- System cable RS-232C
- Digital audio cable
- Microphone with stand
- Wall mounting bracket,
- 2x cover for sockets
- These operating instructions
- Assembly instructions

## Accessories

**Table Stand SOUND PROJECTOR, Catalogue no. 67208 B10**

**FLOOR STAND I 40/60 SP CHROME PLATED, Catalogue no. 69477 C00**

**FLOOR STAND I 55 SP CHROME PLATED, Catalogue no. 69465 C00**

## Set-up in general

- Please refer to the indications in the enclosed assembly instructions.
- Do not set up the unit near strong heat sources or in direct sunlight.
- When setting up in a cupboard or a closed shelf: Allow at least 10 cm clearance around the appliance, so that air can circulate unhindered and no heat build-up occurs. Do not cover the fan and opening at the back.
- This device complies with protection class 1. The power plug must be inserted in a socket with an earth wire connection.
- Incorrect voltages can damage the unit. The unit may only be connected to an electricity supply with the voltage and frequency stated on the rating plate and using the enclosed mains cable.
- During thunderstorms, disconnect the mains plug. A voltage surge caused by lightning conducted through the mains could damage the unit.
- If the unit is not to be used for an extended period, the plug should also be disconnected from the mains.
- The mains plug must be easy to reach to ensure that the unit can be disconnected from the mains at any time.
- Position the mains cable in such a way that it can not be damaged. The mains cable must not have any kinks in it, nor should it be laid over sharp edges, it must not be walked on, nor subjected to any chemicals ; the latter applies to the entire appliance. A mains cable with damaged insulation can cause electric shocks and represents a fire hazard. Stop using the unit immediately if the mains cable is damaged.
- When you want to unplug from the mains, pull on the plug housing rather than on the cable. The cables in the mains plug could otherwise be damaged and could cause a short-circuit when plugged in again.
- Keep the unit away from other electrical household equipment, motors or transformers to avoid buzzing noises.
- Set the unit up in such a way that the infrared signal from the remote control can reach the **Sound Projector** display without being impeded.
- Do not place any strong artificial light source in front of the unit. This could have a detrimental effect on the infrared reception.
- Do not use any force when operating the controls, sockets or cables.

Please also read and follow the safety advice on the following pages.



# For your safety

For your safety, and to avoid unnecessary damage to your unit, please read and follow the safety advice below.

Please keep the safety information in a safe place.

Please also follow the safety instructions that you will find below the left-hand and right-hand covers on the rear of the appliance.

## Use for the intended purpose and ambient conditions

This unit is intended exclusively for playback of audio signals. It is designed for living or office rooms and may not be used in rooms with a high level of **humidity** (e.g. bathroom, sauna) or a high **dust concentration** (e.g. workshops). The terms of the warranty only cover the intended use of the unit.

**ATTENTION** : THE MAINS CABLE OF THIS UNIT MUST BE CONNECTED TO A SOCKET WITH PROTECTIVE GROUND.

This unit is not disconnected from the mains, even when it is switched off, provided it is still plugged into the socket. This status is called **Standby**. In standby the unit only uses a small amount of electricity (page 34).

If the unit is used outdoors, make sure that it is protected from **moisture** (rain, drips, spray or dew).

High concentrations of moisture and dust lead to creepage current in the unit which can make it dangerous if a live wire is touched, or it may cause a fire.

If you have moved the unit out of the **cold** into a warm environment, leave it switched off for about three hours to avoid the formation of **condensation**.

Ensure that your system (**Individual Sound Projector**, TV set and other connected components, if any) are switched off before you connect or disconnect other devices or speakers.

Protect your device from:

- Wetness, dampness, dripping or sprayed water, steam.
- Knocks and mechanical stresses.
- Magnetic and electric fields
- Cold, heat, direct sunlight and high temperature fluctuations
- Dust
- Covers that inhibit ventilation
- Reaching into the inside of the unit

Do not place any **objects** containing a **liquid** on top of the unit. Protect the appliance from dripping and splashing water.

**Candles** and other **open flames** must be kept away from the unit at all times to prevent the spread of fire.



**ATTENTION**: TO AVOID RISK OF ELECTRIC SHOCK, DO NOT REMOVE THE COVER (AND THE BACK OF THE UNIT). THERE ARE NO PARTS INSIDE THE UNIT THAT CAN BE REPAIRED BY THE USER. REPAIRS SHOULD ONLY BE CARRIED OUT BY A LOEWE DEALER.

Use only **genuine accessories and spare parts** from Loewe.

## Volume

Loud music can result in impaired hearing. Avoid extremely loud volume, especially over prolonged periods and when you use headphones.

## Supervision

Do not allow **children** to use the unit/TV set unsupervised. Do not allow children to play in the immediate vicinity of the unit/TV set. Do not operate the unit unattended. If the unit is not to be used for an extended period, the plug should also be disconnected from the mains or switched off.

## Cleaning

Only clean your unit with a slightly damp, soft, clean cloth (without any aggressive or scouring cleaning agents).

## About these operating instructions

The information in this guide refers to the Loewe product **Individual Sound Projector**.

Unless stated otherwise, the instructions refer to the operating elements on the **Assist** remote control.

Paragraphs beginning with the  symbol indicate important hints, tips or conditions for perfect operation.

Terms which you will find in the menu or printed on the unit are printed in **bold type**.

In the functional descriptions, the necessary operating elements are arranged to the left of the text containing the handling instructions.

The diagrams in these operating instructions are only by way of example. The actual display may be different depending on the services available in your system.

Please do read the enclosed document to understand this device and its capabilities. The individual chapters are based on each other and therefore complement each other. Always follow the instructions for setting up, operation and security.

The glossary at the end of the manual (page 33) explains certain terms used in the user interface of the device and in the operating manual.



# Performance

With the Loewe Individual **Sound Projector**, you can enjoy digital surround-sound in the simplest manner. It eliminates the tedious installation and cabling of several speakers distributed across a room.

We use state-of-the-art digital soundprocessor technology to control several small loudspeakers in such a way that directed sound waves and targeted reflection off the walls of your room create the real impression of acoustic spatial perception regardless where you are sitting - as if you were in the thick of the action.

The setup and operation of the **Sound Projector**, especially in conjunction with Loewe TV-sets (from Chassis SL 1xx onwards), is easy.

## **Possibilities for connection**

4x HDMI IN - for extending the connection options in your TV set

1x HDMI OUT

Video Composite-IN

Video Composite Out

Video Component-IN

2x Audio-IN

Audio Digital In

2x Optical Audio Digital-IN

Subwoofer-OUT

FM antenna 75 Ohm

Microphone input

Loewe audio link

RJ12 /RS-232C (system connection to Loewe TV-sets from Chassis SL 1xx onwards)

## **FM Radio**

FM radio with RDS display via cable or terrestrial means

## **Use with other Loewe system components**

Connection of Loewe Flat-TV sets via HDMI/CEC (from Chassis SL 1xx onwards)

Connecting a Loewe Subwoofer via Audio Link

## **Auto setup**

The **Sound Projector** uses an automatic sound beaming and tone optimisation technology. The sound field is precisely matched via a microphone to the sound environment; the tedious setting up of the speakers by listening is thus eliminated.

## **Decoder for a large number of audio formats**

Dolby TrueHD, Dolby Digital Plus, Dolby digital Surround EX, Dolby

Digital, Dolby Pro Logic, Pro Logic II, Pro Logic IIx

DTS-HD Master Audio, DTS-HD High Resolution Audio, DTS 96/24,

DTS-ES, DTS, DTS-ES (discrete and matrix), DTS Neo: 6

Music Enhancer for improving the tone quality of compression artefacts, e.g. with MP3 format

Bass Extension for generating powerful bass sounds

# Setting up

## Setup

- The unit is suitable for various set-up solutions. Please pay attention to the respective mounting instructions.
- Only place the unit with a table or stand on a level, firm, horizontal surface. When being set up, the unit should, in particular, not protrude into or over furniture.

## Positioning in the room

The **Sound Projector** gives out surround sound by reflecting projected sound waves off the walls in your room. The surround sound effect generated by the unit may not be sufficient if the unit is installed in a room with the following characteristics:

- Rooms in which the walls are not suitable for reflecting sound waves.
- Rooms with sound damping surfaces.
- Rooms whose dimensions are greater than the following range:  
width (3 - 7 m) × height (2 - 3.5 m) × depth (3 - 7 m).
- Rooms in which the listening position is less than 1.8 m away from the loudspeaker position.
- Rooms in which, for example, furniture could block the path of the sound beams.
- Rooms in which the listening position is close to the wall.
- Rooms in which the listening position is not in front of the unit.

Install the **Sound Projector** in a position where the path of the sound beams is not impeded by obstacles, such as furniture. Otherwise the desired surround sound effects may not be obtained.

You can install the unit parallel to the wall or in a corner.

### Position parallel to the wall

Install the **Sound Projector** exactly in the middle of the wall, measured precisely from the left and the right corner.

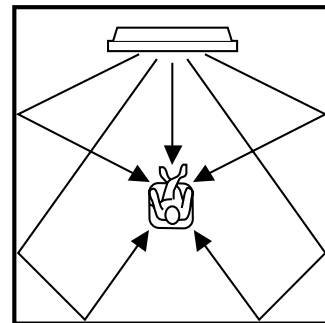
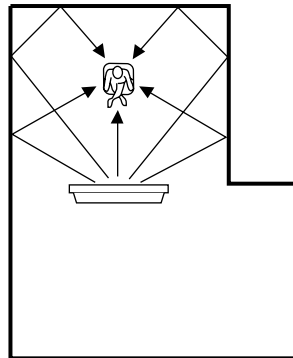

### Position in a corner

Install the **Sound Projector** in a corner at an angle of 40° to 50° to the adjoining walls.

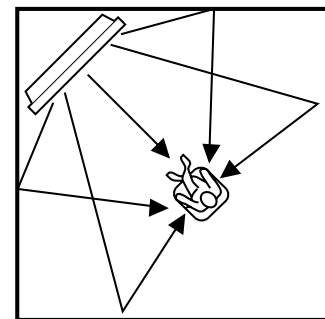
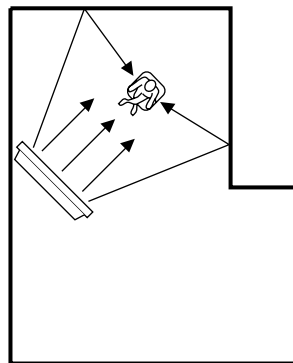

Example: 5.1 Mode.

# Setting up

## Set-up solutions

You can arrange your **Sound Projector** in different set-ups depending on which other equipment you are connecting to it and the layout of the room. You are urgently recommended to use the set-up solutions provided and tested by Loewe. Pay attention to the advice given in the respective enclosed instructions for set-up.

### Wall mounting

You can use the wall bracket supplied to mount your **Sound Projector** on the wall opposite your listening position.



### Mounting on a table

You can use the "Table Stand I Sound Projector" which can be supplied as an accessory, to set up your **Sound Projector** on a flat surface.



### Mounting on a floor stand

You can use the "Floor Stand 5 MU" which can be supplied as an accessory to set up your **Sound Projector** on the floor in conjunction with a Loewe TV set.



Please ask your Loewe dealer about other set-up solutions.

## Connecting the Sound Projector

You can connect various sound sources to the Loewe **Sound Projector**.

- Loewe TV-sets from Chassis SL1xx onwards. The device combination Loewe **Sound Projector** and Loewe TV set (from Chassis SL 1xx onwards) is particularly easy to connect and operate (refer to page 13 onwards).
- Loewe TV sets without RJ12/RS-232C system interface (page 15)
- For additional accessories, see page 8.

# Connecting

## Sound Projector in the Loewe TV Composite System

Connect, using the accompanying RS-232C system cable, the **RJ12/RS-232C** socket of the **Sound Projector** to the **RJ12/RS-232C** socket on your Loewe TV-set (from Chassis SL 1xx onwards). You need to connect this in order to control the **Sound Projector**.

Connect the socket **HDMI OUT** of the **Sound Projector** using the accompanying HDMI cable to a free HDMI socket of your TV-set. Connecting this is optional and is only recommended if you wish to connect further HDMI devices to your TV set using the **Sound Projector**.

Connect the **DIGITAL IN TV** socket of the **Sound Projector** using the accompanying cinch cable (Digital-Audio cable: plug is orange in colour) to the **AUDIO DIGITAL OUT** socket of your TV set. Via this connection, the digital sound signal of the TV set is transmitted to the **Sound Projector**.

Connect the **AUDIO LINK** socket of the **Sound Projector** with an Audio Link cable to the **AUDIO LINK** socket of a Loewe Subwoofer that is available as an accessory. Use the accompanying antenna cable to connect the socket **ANTENNA IN FM** to an antenna socket.

Using the mains cable, connect the socket **AC IN** of the **Sound Projector** to a 220-240V 50/60 Hz socket with protective ground.

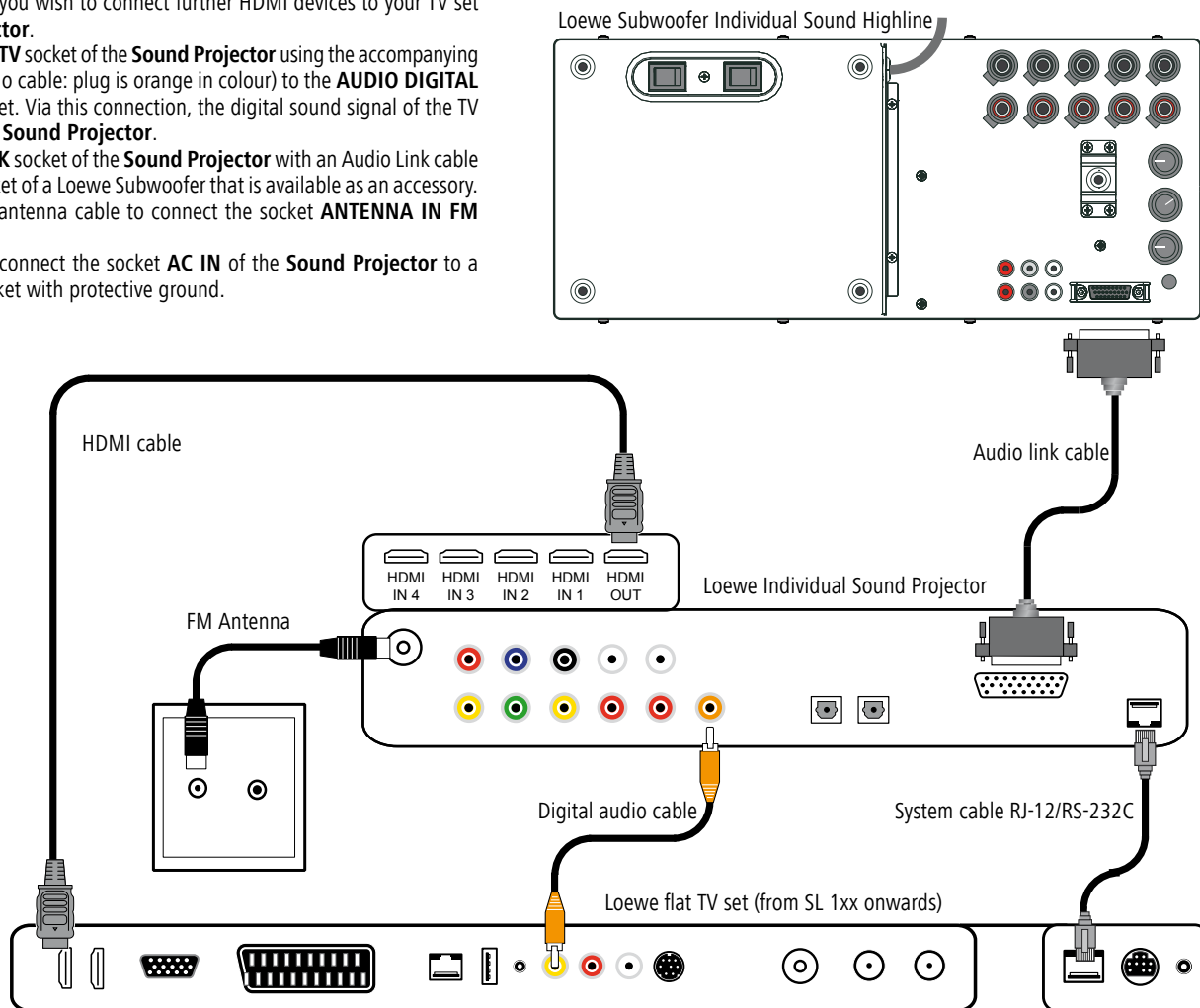

# Connecting

## Sound Projector and Mediacyter in the Loewe TV Composite System

Connect, using the accompanying RS-232C system cable, the **RJ12/RS-232C** socket of the **Sound Projector** to the **RJ12/RS-232C** socket on your Loewe TV-set (from Chassis SL 1xx onwards).

Connect the socket **HDMI OUT** of the **Sound Projector** using the accompanying HDMI cable to a free HDMI socket of your TV-set.

Use a HDMI cable to connect the socket **HDMI OUT** of the Mediacyter with the socket **HDMI IN** on your TV set.

If you wish to connect additional devices (e.g. a Blu-ray player) through an HDMI-connection, then at the **Sound Projector**, the HDMI inputs **HDMI IN 1-4** are available. The signals are looped through to the TV set via **HDMI OUT**.

Connect the **DIGITAL IN TV** socket of the **Sound Projector** using the accompanying Cinch cable (Digital-Audio cable: plug is orange in colour) to the **AUDIO DIGITAL OUT** socket of your TV set. Via this connection, the digital sound signal of the TV set is transmitted to the **Sound Projector**.

Using the audio cable D-SUB/cinch, connect the D-SUB plug with the **AUDIO LINK** socket of the Loewe TV set.

Using the cinch cable (Digital Audio cable: plug is orange in colour),

connect the **AUDIO DIGITAL IN** socket of the **Mediacyter** to the cinch coupling of the audio cable D-SUB/Cinch. The digital audio signal, e.g. for DVB radio on the TV set, is transmitted to the **Mediacyter** through this cable.

Connect the **AUDIO LINK** socket of the **Sound Projector** with an Audio Link cable to the **AUDIO LINK** socket of a Loewe Subwoofer that is available as an accessory. With the antenna cable, connect the **ANT FM** socket of the **Mediacyter** to an antenna socket.

Using the mains cable, connect the socket **AC IN** of the **Sound Projector** to a 220-240V 50/60 Hz socket with protective ground.

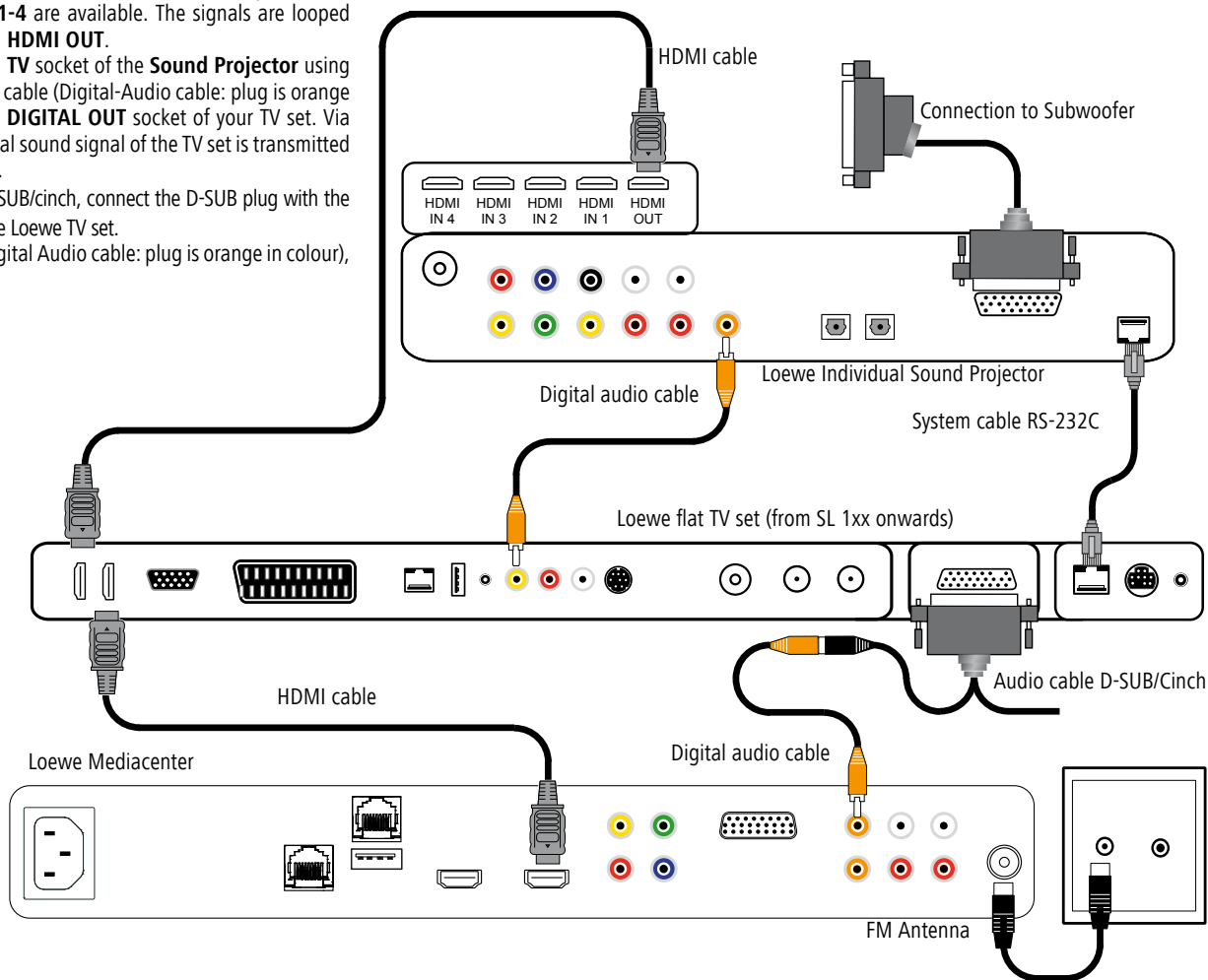

# Connecting

## Connecting to Loewe TV sets without RJ-12/RS-232C system interface

Make the connections as shown here:

Depending on the availability of the interfaces, set up either a **DIGITAL AUDIO/VIDEO**-connection (recommended) or alternatively the **analogue AUDIO/VIDEO**-connection (shown in grey in the figure).

Depending on the requirement, you can connect additional audio sources to the interfaces **DIGITAL IN AUX1/2**, or **AUDIO IN AUX1**.

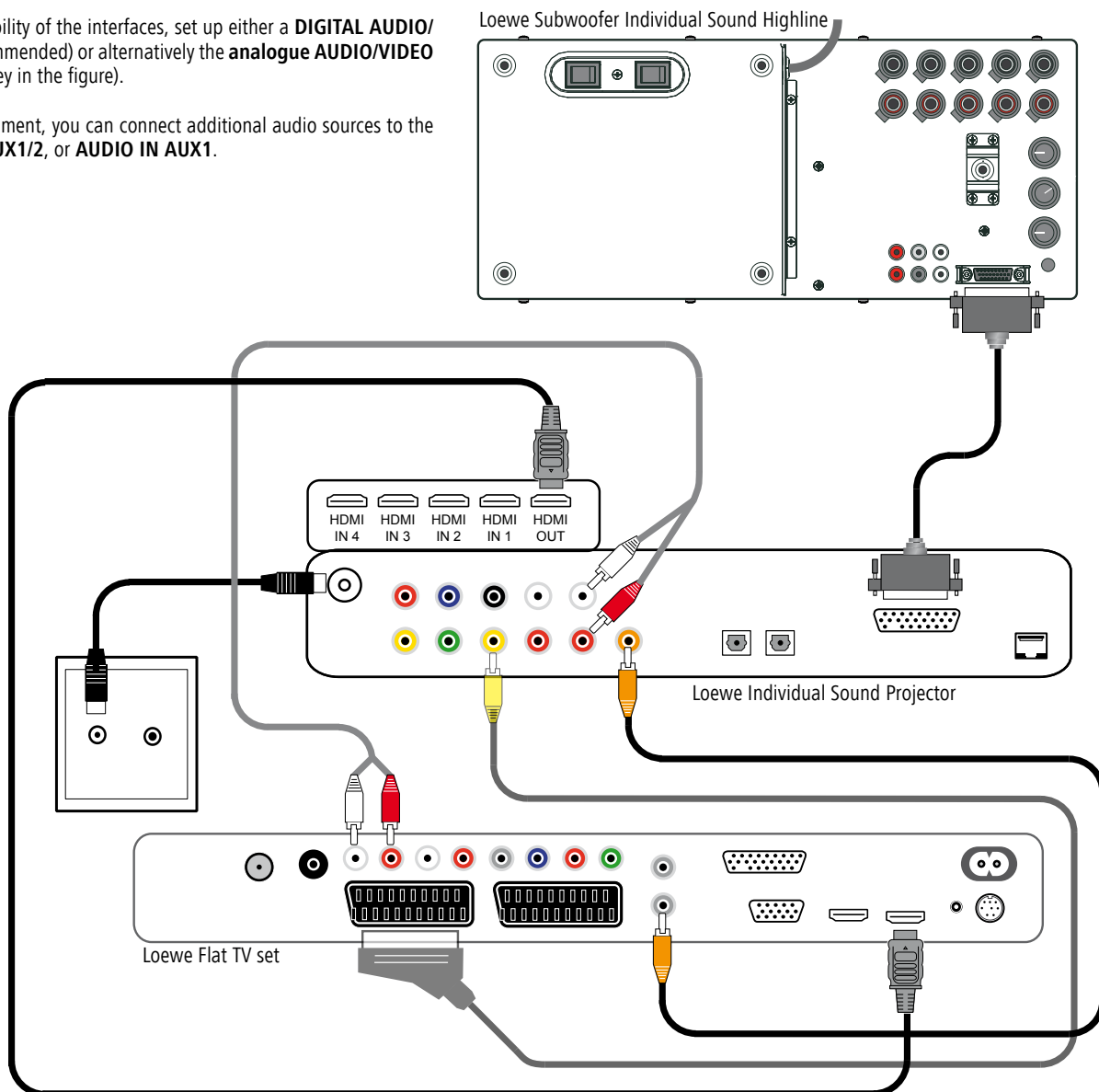

# Start-up

## Using the remote control for the first time





To insert or change the batteries, press where the arrow is embossed on the casing. While doing so, simply slide the battery compartment lid down and remove it. Insert alkaline manganese batteries LR 03 (AAA) and ensure the correct position of + and -. Slide the cover on again from the bottom.

## Setting up the Assist Remote Control

### Other Devices

You can operate various Loewe devices using the **Assist** Remote Control. The device buttons **REC - SP - AUDIO** can be set up for this.

  Press the required device buttons and the Stop button simultaneously for 5 sec. until the corresponding LED display flashes twice.

Then select the two-digit device code from the table:

| Unit                            | Code | Factory setting |
|---------------------------------|------|-----------------|
| Loewe ViewVision 8106 H         | 10   |                 |
| Loewe ViewVision, Centros 21x2  | 12   |                 |
| Loewe ViewVision DR+ DVB-T      | 13   | <b>REC</b>      |
| Loewe Auro 2216 PS/8116 DT      | 14   |                 |
| Loewe BlutechVision             | 15   |                 |
| Loewe Soundprojector 1          | 17   |                 |
| Loewe TV Radio digital          | 19   | <b>AUDIO</b>    |
| Loewe Mediacenter               | 20   |                 |
| Loewe BlutechVision Interactive | 21   |                 |
| HDMI CEC Mode **                | 22   |                 |
| Loewe AudioVision               | 24   |                 |
| Loewe Sound Projector ID        | 25   | <b>SP</b>       |
| Restore defaults                | 99   |                 |

The corresponding LED Display flashes twice.

### Sound functions

It is possible to set the devices with which the buttons with the sound functions (**V+/-**, **Mute** and **sound mode**) should work.

Depending upon which device configuration you use (page 13- page 15), set the device keys and sound functions of the **Assist** remote control. If you use the integrated network configuration as described on page 13, the Loewe TV set will process the sound and the sound functions of the **Assist** remote control do not have to be changed. With a configuration as described on page 14 and page 15, it is necessary to change the sound functions on the **Assist** remote control as described below.



Press the device button **TV** and, at the same time, the button with the single digit function code from the list, for 5 sec. until the LED Display flashes twice.

| Function              | Code | Figure            |
|-----------------------|------|-------------------|
| Loewe AudioVision     | 3    |                   |
| Loewe Mediacenter     | 4    |                   |
| Loewe TV *            | 5    | Page 13 / Page 14 |
| Loewe Sound Projector | 6    | Page 15           |

\* Factory setting

\*\* From chassis L27xx with software  $\geq 9.16$  and chassis SL 1xx with software  $\geq V2.6$

## Operating Loewe Equipment

### Using the remote control for a Loewe TV set



Press **TV** button; the LED Display above it lights up for approx. 5 seconds

### Using the remote control for a Loewe recorder



Press the **REC** button; the LED Display above it lights up for approx. 5 seconds

### Using the remote control for Sound Projector



Press the **SP** button; the LED Display above it lights up for approx. 5 seconds

### Using the remote control for Mediacenter



Press the **AUDIO** button; the LED Display above it lights up for approx. 5 seconds

Every time a button is pressed, the LED display lights up for the selected operating mode for checking purposes (**TV – REC – SP – AUDIO**).

Please refer to the respective operating conditions on how to operate the individual devices.



# Start-up

## Connecting to the Mains Supply

Make the required cable connections as described in section "Connecting" (page 13 - page 15). First remove the left-hand cover at the back of the unit. Insert the smaller three-pin plug of the network cable into the **AC IN** socket (page 7) at the rear of the player, and then insert the mains plug into a 220-240V/50-60 Hz power socket.

## Switching on/off

SP

Set the remote control for **Sound Projector** operation by briefly pressing the button **SP**.

Your **Sound Projector** switches on. If you have connected a Loewe TV set (from Chassis SL 1xx) via HDMI, then this will switch on as well. Otherwise, switch your TV set on and set the respective AV programme slot.

⏻

To switch off the device, press the On/Off switch on your **Sound Projector** or **Assist** (page 3) remote control.

➡ Switch off your **Sound Projector** in case of a prolonged absence, first using the **On/Off button** and then pull the mains plug out. You can thus save energy and protect the environment.

# Start-up

## Acoustic room set-up

For the sound field of the **Sound Projector** to be aligned directly to your listening position, adjust the unit to your actual room. This is done using the microphone supplied and an automatic sequence controlled by the **Sound Projector**. The following steps are required:

- Measuring the actual room
- Optimising the sound beams.
- Optimising the sound (delay, volume, frequency, subwoofer if required).

You can save up to three sound set-ups. This allows you, for example, to take different listening positions, the actual room or TV positions into consideration when using a Loewe TV with swivel castor control. These sound set-ups can then be requested again as required (page 19, page 21).

## Connecting and setting up the microphone

Using the microphone supplied, the **Sound Projector** evaluates the test signals it generates and can thus adapt the sound output to your actual room.

- ➡ Protect the microphone from heat and direct sunlight.
- ➡ Do not use an extension lead for the microphone.
- ➡ Position the microphone at your planned listening position (ear height).
- ➡ Avoid obstacles between the microphone and the walls.
- ➡ With a subwoofer connected where required, set the volume to medium and set the transmission/high-pass frequency to maximum.



Press the on/off button on the unit or



the on/off button on the remote control to switch the unit **off**.

Connect the microphone supplied to the **MIC-IN** socket on the front side of this unit.

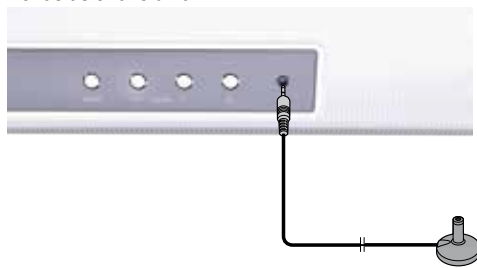

Assemble the stand supplied:

- Separate the individual parts from each other (1).
- Push the two long parts together (2).
- Put the round part on top (3).
- Place the microphone on the assembled tripod (4).

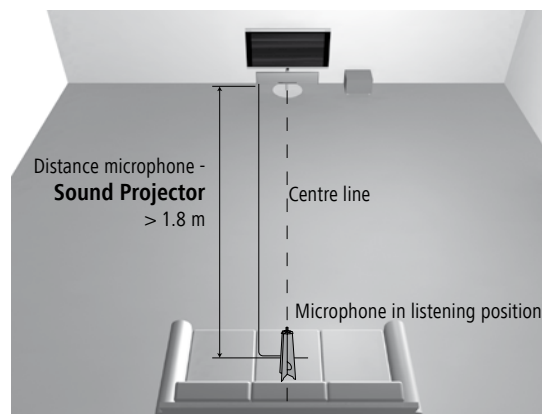
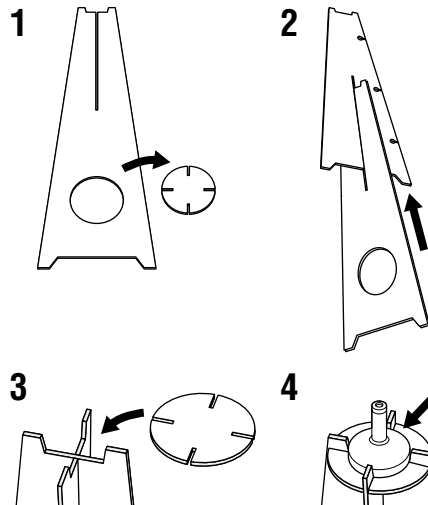

Position the microphone at least 1.8 m away from the **Sound Projector**, centred on it as much as possible, on a level surface. Use the stand supplied to set up the microphone at the height of your required listening position, pointing upwards.

# Start-up

## Auto setup (TV sets with RJ-12/RS-232C System interface)

► Ensure that the devices are set up correctly (page 11, page 12), all cables are connected properly (page 13-page 14) and that the microphone is connected and positioned correctly (page 18).



Set the remote control for TV operation. The Loewe TV set switches on automatically.



Call up the **TV menu**.



◀ ▶ Select **Connections**.

▼ Change to the menu line below.

◀ ▶ Select **Sound components**.

Confirm **OK**.

The selection **SOUND COMPONENTS - Sound playback via ...** appears.

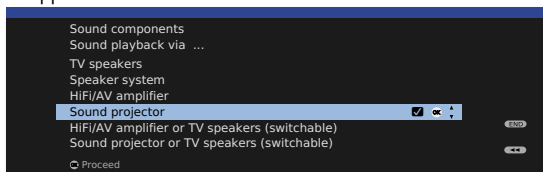

▲ ▼ Select **Sound projector** or **Sound projector or TV speakers (switchable)** (page 28).

Confirm **OK**.

The **Sound Projector** switches on automatically.

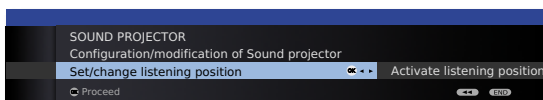

**OK** Call up menu **Set/change listening position**.

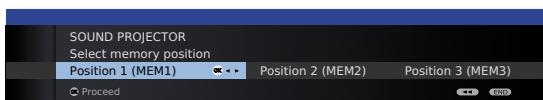

◀ ▶ Select one of the three memory positions **Position 1-3 (MEM1-3)**.

Confirm **OK**.

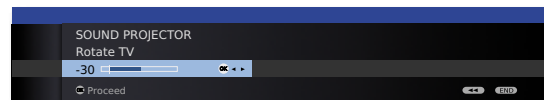

If the Loewe TV set is equipped with swivel castor control, now use ◀ ▶ to turn the TV to the required listening position.

Confirm **OK**.

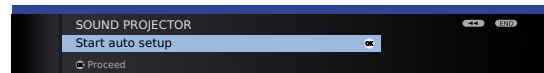

**OK** Start auto set-up.

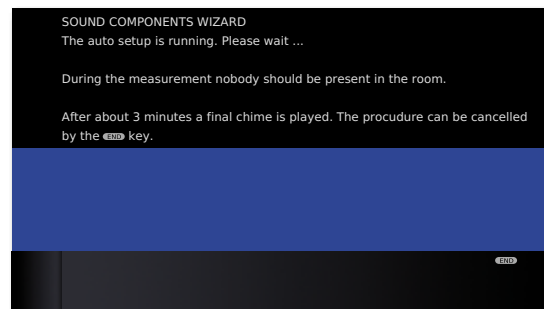

# Start-up

- ▶ During auto set-up, the listening room should be free of noise interference. Please leave the room during this time so that the sound beams can spread without disturbance.
- ▶ If an error occurs during auto set-up, a warning will sound and a message will appear on the TV screen (page 32). If necessary, check the conditions described above for the **Sound Projector** to work perfectly.
- ▶ Auto set-up takes about 3 minutes and a chime sounds when it finishes.
- ▶ You can save three listening positions and call them up again, e.g., to take changing conditions in the listening room into consideration.
- ▶ Position the microphone at least 1.8 m away from the **Sound Projector** centred on it on a level surface.

After auto set-up has been completed, a message will appear on the screen.

## Example 1 - Successful auto set-up:

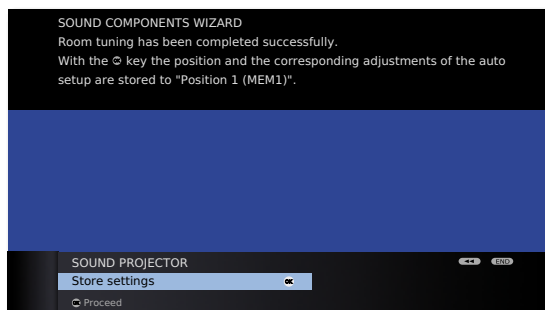

## Example 2 - Failed auto set-up:

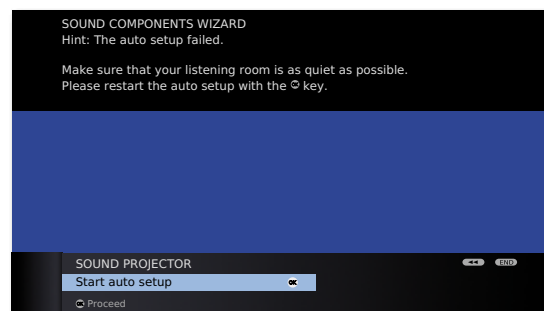

- ▶ If the message "Note: The auto set-up failed due to problem E-1 (room is too noisy)" is displayed, please repeat the auto set-up process. Please also read the "Error messages for auto set-up" on page 32.

## OK Apply results of auto set-up.

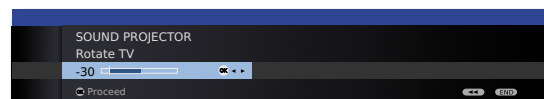

If the Loewe TV set is equipped with swivel castor control, use ◀ ▶ to turn the TV to the required listening position.

END

Close the menu.

Remove the microphone now from the **Sound Projector**.

The **Sound Projector** is now ready.

You will find information on operating the **Sound Projector** from page 23 onwards.

# Start-up

## Auto setup (TV sets without RJ-12/RS-232C System interface)

- Ensure that the devices are set up correctly (page 11, page 12), all cables are connected properly (page 13 - page 15) and that the microphone is connected and positioned correctly (page 18).

### Settings on TV set

On your TV set, (with Loewe TV sets in the "Sound components wizard"), set the audio output to **HiFi/AV amplifier**.

### Setting user interface language

TV

Set the remote control for TV operation.

0  
AV

Call up **AV selection**.

On your TV set, select the **AV station preset** to which the **Sound Projector** is connected. You can find the details in the operating manual of your TV set.

SP

Set the remote control for **Sound Projector** operation. The **Sound Projector** switches on automatically.

MENU

Press and hold down the **MENU button**.

The menu **Language Setup** appears.

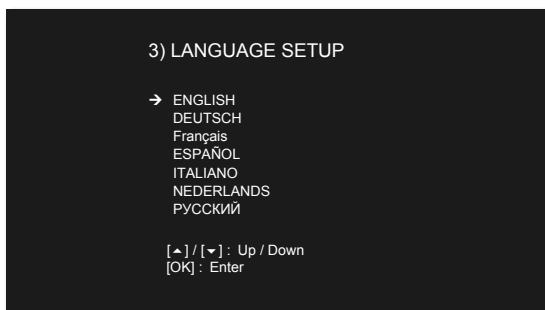

▲ ▼ Select the required language.

Confirm **OK**.

The display of the **Sound Projector** also shows the selected language (display here always in English).

## Starting auto set-up

INFO

Press and hold down the **INFO button**.

The menu **Auto Setup** appears.

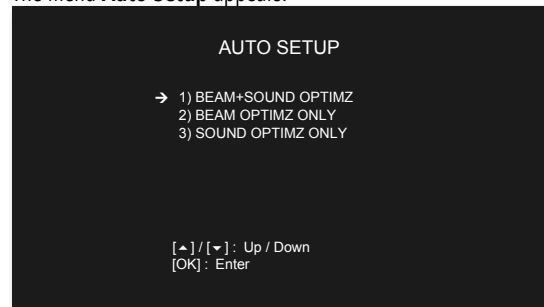

▲ ▼ Select option 1. Confirm **OK**.

**OK** Start auto set-up.

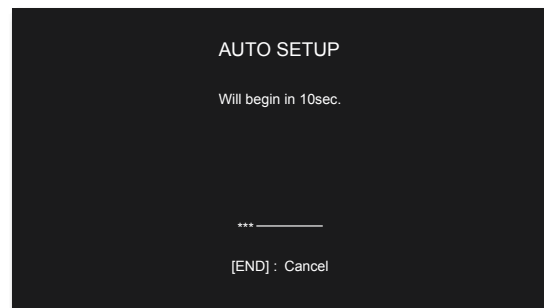

- During auto set-up, the listening room should be free of noise interference. Please leave the room during this time so that the sound beams can spread without disturbance.
- If an error occurs during the auto set-up, a warning tone will sound and a message will appear on the TV screen (page 32). If necessary, check the conditions described above for the **Sound Projector** to work perfectly.
- Auto set-up takes about 3 minutes and a chime sounds when it finishes.
- You can save three listening positions and call them up again, e.g., to take changing conditions in the listening room into consideration.
- Position the microphone at least 1.8 m away from the **Sound Projector** centred on it on a level surface.

# Start-up

After auto set-up has been completed, a message will appear on the screen.

Example 1 - Successful auto set-up:

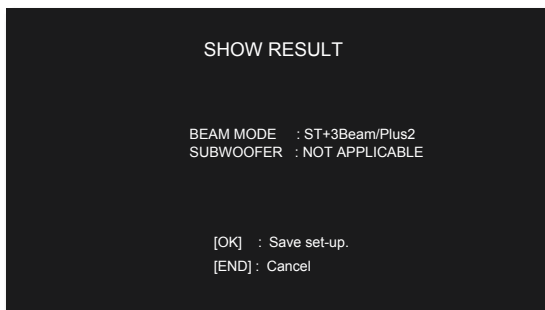

Example 2 - Failed auto set-up:

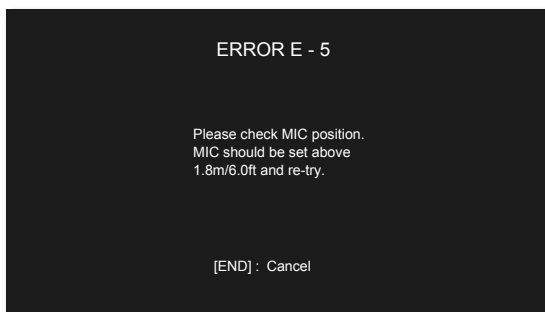

- ▣ If an error message is displayed, correct the conditions and then please repeat the auto set-up. Please also read the "Error messages for auto set-up" on page 32.

**OK** Apply results of auto set-up.

Remove the microphone now from the **Sound Projector**.

The **Sound Projector** is now ready.

You will find information on operating the **Sound Projector** from page 23 onwards.

## Saving sound set-up

You can save up to three sound set-ups. This allows you, for example, to take different listening positions, the actual room or TV positions into consideration when using a Loewe TV with swivel castor control. You can then call up these sound set-ups at any time.

TEXT

Press the button for a long time. The menu **Memory** is displayed.

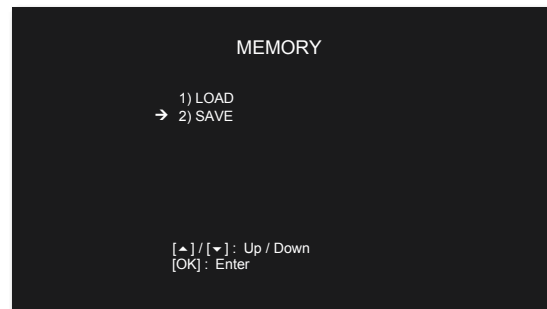

▲ ▼ Select the option **Save**.

Confirm **OK**.

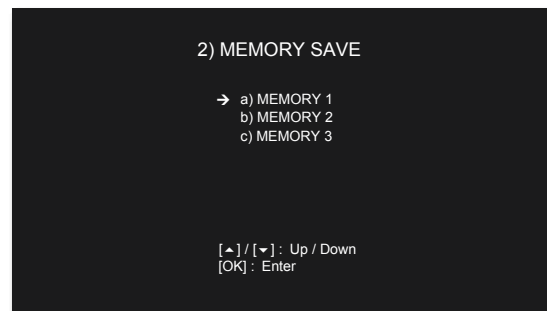

▲ ▼ Select the option **MEMORY1-3**.

Confirm **OK**.

- ▣ All settings you adjusted in the **Sound Projector** menus are permanently stored by saving.

# Everyday Use

## Playback

### Switch sound on/off



Sound off;

Sound on: Press the button again or set the **V+/-** volume (loudness).

### Adjusting volume

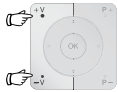

**V+ / V-** volume up / down

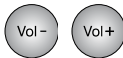

or on the unit, press **Volume - / +**.

### Other sound settings for TV sets with RS-232C System Interface

As long as the volume bar or the selection of loudspeakers can still be seen in listening mode.



- ▲ Call up additional sound settings.
- ◀ ▶ Select sound settings.
- ▼ Change to the menu line below.
- ◀ ▶ Make changes.

You can also make sound settings in Loewe TV sets from Chassis SL 1xx onwards in **TV-MENU – Sound**.

## Loading listening position

You can call up the listening position that you saved previously (page 19, page 21).

### TV sets with RS-232C system interface



No further menu is shown.

◀ ▶ Select the listening position.

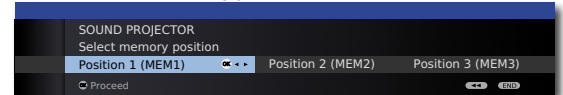

◀ ▶ Select one of the three memory positions **Position 1-3 (MEM1-3)**.

Confirm **OK**.

### TV sets with an RS-232C system interface and swivel castor control



No further menu is shown.

◀ ▶ Select the listening position.

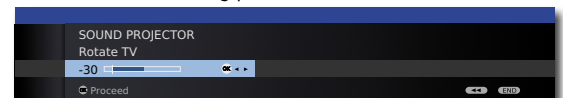

◀ ▶ Select one of the three memory positions **Position 1-3 (MEM1-3)**. These are marked on the bar.

## Selecting signal source

You can play back the sound from the devices connected to the **Sound Projector**.



Set the remote control for **Sound Projector** operation.



Press **AUX (PIP)** on the remote control several times



or press **SOURCE** several times on the unit to select the required signal source.

The name of the selected input signal source and the type of corresponding input mode are shown on the **Sound Projector** display.

# Everyday Use

## TV sets without RS-232C system interface

TEXT

Press the button for a long time. The menu **Memory** is displayed.

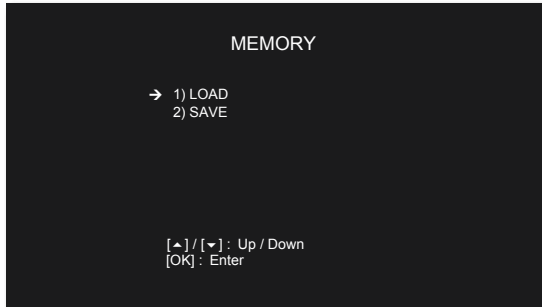

▲ ▼ Select the option **Load**.

Confirm **OK**.

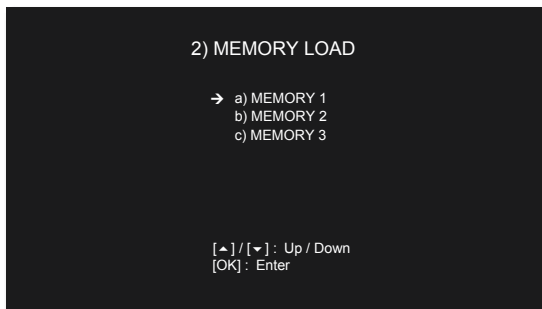

▲ ▼ Select the option **MEMORY 1-3**.

Confirm **OK** 2x.

## Select sound mode

You can choose from various surround sound modes.



Select sound mode by pressing several times.

**5 Beam(2)** The sound beams of all the 5 channels are output.

The surround sound effects come into their own when they play back media recorded in multichannel format.

**Stereo+3 Beam(2)** The sound is emitted directly in stereo via and left and right front channel as well as via the centre channel. The left and right surround channels are emitted via sound beams. This mode is suitable for playing back live recordings for example. Singing and instrumental sounds can be appreciated best near the middle position, where the sound reflections generated locally can be heard on your left and right.

**3 Beam** The left front and surround channel, as well as the right front and surround channel, are emitted via sound beams. The centre channel is emitted directly. This mode is most suitable for watching films with the whole family due to the extended listening position range. You can also use this mode if the listening position is near the back wall meaning that the left and right surround beam can not be reflected.

**Stereo** The sound is emitted in stereo via the left and right front channels.



# Everyday Use

## Select decoder mode

You can set the decoder for playing back DTS audio signals.

- ➡ In most cases, setting the input mode to **AUTO** is recommended.



Set the remote control for **Sound Projector** operation.



Select the decoder mode by pressing **IN-MODE** several times.

**Auto** The Decoder automatically sets itself to the input signal

**DTS** The Decoder processes DTS signals exclusively

### Decoder displays

Depending on the input signal source and the surround mode selected, the indicators on the **Sound Projector** display light up as follows:

|  |                          |  |
|--|--------------------------|--|
|  | PCM                      | Playback of PCM signals (Stereo)   |
|  | <b>dts</b>               | Playback of DTS signals  |
|  | <b>dts</b> + Neo:6       | Playback of stereo signals in the DTS-Neo: 6 mode (Stereo to 5.1-signal conversion)  |
|  | <b>dts</b> + 96/24       | Playback of DTS 96/24 signals  |
|  | <b>dts</b> + ES + DSCRT  | Playback of discrete DTS ES-signals  |
|  | <b>dts</b> + ES + MTRX   | Playback of discrete DTS ES matrix signals   |
|  | <b>dts</b> + HD + MSTR   | Playback of DTS HD Master Audio signals  |
|  | <b>dts</b> + HD + HI RES | Playback of DTS HD Hi Resolution signals   |
|  | <b>DIGITAL</b>           | Playback of Dolby Digital signals  |
|  | <b>PL</b>                | Playback of Stereo signals in the Dolby-Pro-Logic Mode (Stereo to 5.1-Signal conversion)   |
|  | <b>PL II</b>             | Playback of Stereo signals in the Dolby-Pro-Logic II Mode (Stereo to 5.1-Signal conversion)  |
|  | <b>PL II x</b>           | Playback of Stereo- or 5.1-signals in the Dolby-Pro-Logic-IIx Mode (Stereo to 5.1-Signal conversion) (only in case of Beam mode "7.1ch") |
|  | <b>DIGITAL PLUS</b>      | Playback of Dolby Digital Plus signals   |
|  | <b>TRUE HD</b>           | Playback of Dolby TrueHD signals   |
|  | <b>EX</b>                | Playback of Dolby Digital EX signals   |

## Playback of 2-channel signal sources with surround sound

The unit can process 2-channel signal sources for 5.1/7.1 channel playback in such a way that by switching the surround mode, you can enjoy a number of surround sound effects.

- ➡ The surround modes are only available if the sound field programmes have been deactivated (page 26). Moreover, the sound mode has to be set to 5-Beam mode 2, stereo-plus 3-Beam mode or to 3-Beam mode (page 20).



Press several times to select surround mode.

**PRO LOGIC, PLIIx Movie, PLIIx Music, PLIIx Game, Neo:6 Cinema, NEO:6 Music**

- ➡ If **NOT AVAILABLE** is shown, then the function you want is not possible.

### Surround modes and recommended signal sources

**Surround mode** recommended signal source

**dts Neo: 6** Films, Music

**PL** All signal sources

**PL II** Films, music, games

- ➡ The surround modes are available if another sound beam mode is selected as the stereo playback.
- ➡ If you select an input signal source (page 23), the surround mode that was used for the previous input signal source selected is retained.
- ➡ If you switch this unit off and on again, the surround mode used for the previous input signal source selected before switching off is retained.
- ➡ The surround modes are only available if the sound field programmes have been deactivated (page 26).
- ➡ If you press the button **ASSIST** on the remote control and no surround modes are available, **NOT AVAILABLE** will appear on the display of the **Sound Projectors**.
- ➡ The surround modes are only available if 2-channel signals have been set up. If you try to switch between surround modes when 5.1-channel signals are set up, **NOT AVAILABLE** will appear on the display of the **Sound Projectors**.

# Everyday Use

## Sound field programmes

The unit is equipped with a digital sound field processor which contains several sound field programmes which you can use to enhance your listening pleasure. Most of the sound field programmes are precise digital reproductions of acoustic environments which actually exist whether famous concert halls, music performance venues and cinemas.

The numerous reflections from the walls of the room are an important factor which contribute towards producing the rich, full sound of a real instrument. These reflections not only bring the sound to life, but also allow the listener to locate the precise position of the instruments and to define the size and shape of the room the listener is sitting in.

### Activating sound field programmes

Using the colour keys of the remote control **Assist**, you can select the following sound field programmes based on your own listening preferences while playing back music, films or sports programmes.

 Select the sound field programme **MUSIC**. By pressing several times, select the programmes **Music Video**, **Concert Hall** and **Jazz Club**.

 Select the sound field programme **MOVIE**. By pressing several times, select the programmes **Sci-Fi**, **Spectacle** and **Adventure**.

 Select the sound field programme **SHOW**. By pressing several times in succession, select the programmes **Sports**, **Talk Show**, **Drama**, **Game** and **Mch Stereo**.

 Switch off the sound field programme.

| Sound field programme | Source       | Description  |
|-----------------------|--------------|--|
| Music Video           | <b>MUSIC</b> | This programme gives you the feeling of being at an actual jazz or rock concert.   |
| Concert Hall          |              | This programme generates an atmospheric effect of a large, round concert hall and makes you feel as if you are sitting close to the middle of the stage. |
| Jazz Club             |              | This programme recreates the acoustic environment of "The Bottom Line", a famous jazz club in New York.  |

| Sound field programme | Source       | Description   |
|-----------------------|--------------|---|
| Sci-Fi                | <b>MOVIE</b> | This programme reproduces dialogue and sound effects in modern science fiction films with great clarity.  |
| Spectacle             |              | This programme reproduces an expansive, spacious environment and conveys the impression of spectacular scenes.  |
| Adventure             |              | This programme reproduces the enthralling environment of the newest action films and allows you to feel the dynamics and excitement of fast scenes.   |
| Sports                | <b>SHOW</b>  | This programme reproduces the environment of live sports programmes, merges the commentator's voice in the centre with the overall atmosphere of the stadium and gives you the feeling of being in the middle of the stadium or of sitting in the grandstand.   |
| Talk Show             |              | This programme reproduces the acoustics during live talk shows. It plays back the conversations at a comfortable volume level.  |
| Drama                 |              | This programme generates a stable reverberation, which is suitable for various film genres: from dramatic works and musicals to comedies.   |
| Game                  |              | This programme is suitable for role-playing and adventure games. It uses the sound field effects for films, to be able to provide depth and a three-dimensional listening experience during game sequences, whereas a cinema-like sound is generated during the film sequences of the video game. The sound delay is set to a minimum here. |
| Mch Stereo            |              | This program mixes multichannel sources on 2 channels and plays back the sound over all the channels. This achieves a broad range of stereo sounds. It is ideally suited for background music, e.g. during parties.   |

# Everyday Use

## 5.1/7.1-channel mode

This unit can decode 5.1-channel sources and play them back as surround sound with up to 7.1 channels. Depending on the selected input source, one of the following decoders is selected automatically. To do so, set the **number of channels** to **7.1 ch** (page 30).



Press several times to select the required mode.

## Bass mode

You can change the bass playback in two stages.



Press the button **BASS** several times to select the required bass mode.

Select **Bass Ext : Mid** for moderate bass effects.

Select **Bass Ext : Deep** for maximum bass effects.

Select **Bass Ext : Off** to turn off the function.

# Everyday Use

## Sound menu functions for Loewe TV sets with RJ-12/RS-232C System Interface

If the **Sound Projector** is being operated in connection with a Loewe TV set with an RS-232C system interface (page 13), some special menus will appear on the TV set.



Call up the **TV menu**.

- ◀ ▶ Select **sound**.
- ▼ Switch to the menu line below it.
- ◀ ▶ Select desired option.

### Sound mode

See page 24.

### Subwoofer

Here you can set individual parameters for a Loewe Individual Sound System (Subwoofer) connected to the **Sound Projector** via Loewe Audio Link (page 13).

|                             |                           |
|-----------------------------|---------------------------|
| <b>Connected</b>            | yes / no                  |
| <b>Cross over frequency</b> | 80 / 100 / 120 Hz         |
| <b>LFE LEVEL</b>            | -20 dB ... 0 dB.          |
| <b>Distance</b>             | to the listening position |

### 5/7 channels

Here you can set the Room Parameters for setting up the system in your environment.

- Select 5 channels** 5.1 playback
- Select 7 channels** 7.1 playback

### Select DD/DTS dynamics range

Here you can set parameters for the required dynamics range of the Sound Projector.

**DD/DTS-Dynamics range** Min / Standard / Max

### Sound via

Here you can select whether you want to play back the sound through the loudspeaker or using the **Sound Projector**. To do so, in the menu **Sound components - Sound playback via ...** choose the setting **Sound Projector or TV speaker (switchable)** (page 19).

**Sound via** TV / Sound projector

## Sound menu functions for Loewe TV sets without RJ-12/RS-232C System Interface

You can make basic changes in the **Sound menu** on the **Sound Projector**.



Select **AV programme slot** of the TV-set to which the **Sound Projector** is connected. Confirm **OK**.



Set the remote control for **Sound Projector** operation. The **Sound Projector** switches on automatically.



Press the **MENU** briefly. The menu **Settings** appears.



▲ ▼ Select the option **Sound**. Confirm **OK**.

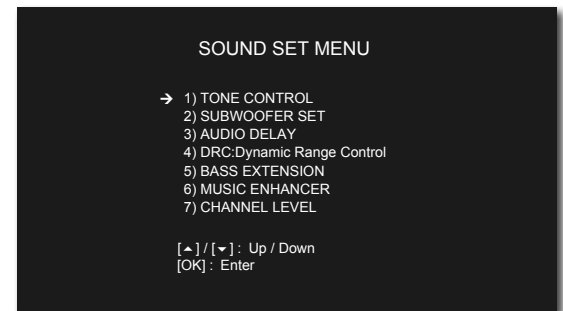

▲ ▼ Select desired option.

- Tone control** You can set the proportion of **Highs** and **Lows**
- Subwoofer Set** You can set the parameters for a Subwoofer connected to the **Sound Projector**, such as **Bass output, cross over frequency, LFE level and distance** to the listening position.
- Audio delay** You can set the delay time between sound and picture to obtain lip-synced playback
- DRC: Dynamic Range Control** Here, you can select the parameters for the desired Setting the dynamics range of the **Sound Projector**
- Bass Extension** You can set the parameters for the bass mode here
- Music Enhancer** Serves for switching the Enhancer on or off for compressed audio signals **AUX1/2**
- Channel level** Serves for setting the loudness of the individual channels.

Confirm **OK**.

# Everyday Use

You can receive FM radio stations with your **Sound Projector**. The device can save up to 40 stations. If the station transmits additional information via RDS, it can be shown on the **Sound Projector** display.

## Radio Setup

Connect your **Sound Projector** via the **FM ANTENNA IN** socket (page 7) and the antenna cable supplied with an FM antenna socket (page 13).

 Set the remote control **ASSIST** for FM radio operation by pressing the **SP** button and holding it.

### Automatic search

 Pressing the button and holding it down: The FM radio reception range is automatically scanned and the radio stations found are continuously saved.

### Setting the stations manually

 Press the button: **Manual Preset** is displayed.



**P+ / P-** Select the desired memory location for the station.

 Briefly: fine-tuning forward; long: search forward.

 Briefly: fine-tuning backwards; long: search backwards.

or



Input the transmitter frequency of the station, e.g. 8900 for 89.00 MHz (two decimal places).

 Pressing the button briefly: The frequency that has been set is automatically stored at the previously selected memory location.

►► If required, save the station to another memory position before overwriting it with another station.

## Radio Operation

 Set the remote control **ASSIST** for FM radio operation by pressing the **SP** button and holding it.



**P+ / P-** Select station up/down.



Enter the two digit station number.



Press several times: Select RDS display

|                          |                       |
|--------------------------|-----------------------|
| <b>Programme Service</b> | Station name          |
| <b>Programme Type</b>    | Programme type        |
| <b>Radio Text</b>        | Text messages         |
| <b>Clock Time</b>        | Time                  |
| <b>Frequency</b>         | Transmitter frequency |



**V+ / V-** Volume up / down.



Sound on / off.

# Other settings

If required, you can configure additional parameters in the Settings menu of the **Sound Projector**. These settings are only intended for trained technical personnel.

- ➡ Unless you have sufficient expertise, do not make any changes to the settings in this area, as this may maladjust the unit to an extent that it no longer works properly afterwards.

## Loudspeakers

You can determine the number of sound beam output channels and the audio output mode.

Select **AV station preset** of the TV-set to which the **Sound Projector** is connected.



Set the remote control for **Sound Projector** operation. The **Sound Projector** switches on automatically.



Press the **MENU** briefly. The menu **Settings** appears.



▲ ▼ Select the option **Loudspeakers**.

Confirm **OK** 2x.



- Number of channels** Set **5.1 ch** or **7.1 ch** mode
- Beam mode** Depending on your setting for **Number of channels**, you can choose to set
- 5.1 ch**: 3 Beam or Stereo + 3 Beam or 5 Beam, or
  - 7.1 ch**: 3 Beam, Stereo + 3 Beam plus 2 or 5 Beam plus 2 (also see Listening mode on page 24)

## Connections

You can make basic settings for the inputs/outputs.

### Assign connections

You can assign analogue and digital wired (coaxial) and optical inputs respectively to the video inputs (page 23).

### Renaming the connections

You can rename the connections, e.g. so that it can be seen from the display of the **Sound Projector**, which connected units (e.g. Blu-ray-Player) are set upon selecting the signal source (page 23).

### Setting HDMI

Here, you can make additional settings for the HDMI-interfaces.

- Support Audio** Select **Loewe SP** to play back HDMI audio signals on that unit. Select **Other**, to play back HDMI audio signals on one of the components connected to the **HDMI OUT** socket
- Audio select** Here, you can set whether the audio channel of the **HDMI-IN**-sockets **1-4** should be active
- HDMI control** Set this option to **On** if your TV-set and the connected sets (e.g. Blu-ray-Player) support the HDMI CEC function. There is then an automatic switch-over to the respective HDMI source.

## Display

You can make settings for the device display of the **Sound Projector**.

- F.DISPLAYSETUP** You can set the brightness of the display here
- OSD setup** You can adjust the colour and position of the menu **Settings** here.
- Language setup** You can set the language of the operating interface here (see page 21)
- Unit setup** You can set the unit of measure to feet or metres

# Troubleshooting

| Problem  | Possible Cause  | Remedy   |
|--|---|--|
| Not working at all   | Mains cable not plugged in.   | Plug the mains cable firmly into the socket on the Sound Projector and then into a 220-240 V 50 Hz socket with protective ground.  |
| The unit suddenly switches to standby.                                 | The internal temperature is too high which has activated the protective circuit to avoid overheating. | Wait for approx. 1 hour until the unit has cooled down and then switch it on again.  |
| No sound.  | Faulty connections of input or output cables.   | Connect the cables properly (page 13 - page 15). If the problem persists, it is possible that the cables are faulty.   |
|  | No suitable input signal source has been selected.  | Select a suitable input source using <b>AUX (PIP)</b> or <b>SOURCE</b> .   |
|  | The volume is set at minimum.   | Turn up the volume.  |
|  | The sound is set to mute.   | Press  or <b>V +</b> on the remote control to activate audio output again and then adjust the volume. |
| No sound from the effect channels.                                     | You are trying to play back the signal source or the programme in stereo.                             | Press one of the sound field programme buttons on the remote control to select a multichannel playback mode and try again to play back the signal source or the programme.               |
| No sound from the centre or the surround channels.                     | The source level of the affected channel is set to minimum.   | Increase the level of the channel (page 28).   |
| The surround sound effects can hardly be heard.                        | The listening room has an irregular shape.  | Install this unit in a square or rectangular room (page 11).   |
|  | There is no reflection wall for the sound beam.   | Try setting up a flat object, such as a screen, as a replacement wall.   |
| There is noise interference if no subwoofer is connected to this unit. | The protective circuit was active because a source with strong bass elements was being played.        | Reduce the volume or connect a subwoofer and set the settings for a subwoofer via the <b>sound menu</b> (page 28).   |
| The on-screen dialogue (OSD) does not appear.                          | The socket <b>VIDEO OUT/HDMI</b> on this unit is not connected to the input sockets on your TV set.   | Connect the socket <b>VIDEO OUT</b> (Composite) on this unit to the input sockets on your TV set.  |
| The unit is not working properly.                                      |   | Unplug the mains plug from the mains socket and then try plugging it in again after 30 seconds.  |
| The sound effects are not satisfactory.                                | The original signal source contains surround effects.   | Deactivate the surround effect settings on this unit.  |
| Auto set-up is unsuccessful.   |   | See the error messages on page 32.   |
| The remote control is not working properly.                            | The batteries in the remote control are dead.   | Replace the batteries with new ones.<br>Set the remote control for Sound Projector operation.  |

# Troubleshooting

## Error messages for auto set-up

| Error Message | Possible Cause  | Remedy   |
|---------------|---|--|
| ERROR E-1     | Your listening room has too much undesirable noise.   | Ensure that it is as quiet as possible in your listening room.   |
| ERROR E-2     | The optimisation microphone was disconnected during auto set-up.  | Ensure that the optimisation microphone is firmly connected to the unit (page 18).   |
| ERROR E-3     | During auto set-up other operating processes were run on this unit.   | During auto set-up do not carry out any other operating processes.   |
| ERROR E-4     | The optimisation microphone is not in front of this unit.   | Ensure that the optimisation microphone is positioned in front of this unit.   |
| ERROR E-5     | The optimisation microphone is not positioned at the right distance from this unit.                                   | Ensure that the optimisation microphone is more than 1.8 m from the front of the unit and is within 1 m of the mid-height position of the unit.            |
| ERROR E-6     | The optimisation microphone cannot receive the sound produced by this unit because the sound output level is too low. | Ensure that the optimisation microphone is firmly connected to this unit and has been set up properly. If the problem persists, contact your Loewe dealer. |
| ERROR E-7     | An internal system error has occurred.  | Repeat the auto set-up.  |



# Glossary

## A

**AV-socket:** Socket for audio and video signals.

**AV-sources:** Audio/Video source.

## C

**CEC:** Abbreviation for Consumer Electronics Control. CEC makes overall component control functions available for consumer electronics devices (e.g. System-Standby, One Touch Play). CEC is referred to at Loewe as Digital Link HD.

**Cinch cable:** Cable for transmitting sound or pictures.

**Component IN:** Connection via which the video signal is transmitted using three separate cinch connections. It is made up of the brightness signal "Y" and the colour difference signals "Pb" and "Pr". YPbPr is the original analogue version of digital YCbCr, which colour codes the video data saved on the DVD or transmitted with DVB per Sat, cable or antenna.

## D

**Digital Link HD:** System for controlling units via the HDMI connection of the Loewe TV set when they have been set up in a covered position.

**Dolby Digital:** Digital multichannel sound. The digital standard for high-quality home theatre systems. In this standard, the individual channels are transmitted separately. The three front channels right, left and centre, the two surround channels right and left, and the external subwoofer channel are called the 5.1-Signal.

**Dolby Digital Plus:** This is a highly developed audio technology, developed for High Definition media including HD transmissions and Blu-ray Disc. Selected as an optional audio standard for Blu-ray Disc, this technology supplies multichannel sound for discrete channel output. With support for up to 6.0 Mbps, Dolby Digital Plus can carry up to 7.1 discrete audio channels simultaneously. Supported by the HDMI Version 1.3 and designed for the optical disc players and AV-receiver/amplifiers of the future, Dolby Digital Plus also remains fully compatible with existing multichannel audio systems that contain Dolby Digital.

**Dolby Digital Surround EX:** Generates 6 output channels from 5.1-channel sources with full bandwidth. For best results, Dolby Digital EX should be used for films whose soundtracks have been recorded with Dolby Digital Surround EX. With this additional channel, you can enjoy more dynamics and realistically moving sound, especially in scenes with "fly-over" and "fly-around" effects.

**Dolby Pro Logic II:** Analogue multichannel sound. Dolby Pro Logic II is a further development of Dolby Pro Logic. This process generates, from a stereo or Pro-Logic signal, a 6-channel spatial sound (front left, centre, front right, surround left, surround right, subwoofer).

**Dolby Pro Logic IIx:** This is a new technology that allows a discrete multichannel playback of 2-channel or multichannel signal sources. There are 3 modes available for selection: "Music mode" for music sources, "Movie mode" for film sources (only two-channel sources) and "Game Mode" for video game sources.

**Dolby Surround:** An analogue surround sound system which uses a matrix coding to fit four sound channels into two sound tracks.

**Dolby TrueHD:** This is a highly developed audio technology developed for HD media, including Blu-ray Disc. Selected as an optional audio standard for Blu-ray Disc, this technology delivers sound that is identical to the Studio Master bit-by-bit, and gives a home-theatre experience. By supporting bit rates up to 18.0 Mbps, Dolby TrueHD can simultaneously carry up to 8 discrete channels of 24-bit/96 kHz audio. Dolby TrueHD is also fully compatible with existing multichannel audio systems and has the same meta-data functionality as Dolby Digital already does, because of which dialogue normalisation and dynamic range control become possible.

**DTS 96/24:** offers a never-before achieved level of tone quality for multichannel sound on DVD video and is completely downward-compatible with all DTS decoders. "96" refers to a polling rate of 96 kHz (as against the typical polling rate of 48 kHz). "24" refers to the 24-bit word length. DTS 96/24 provides a tone quality that is transparent to the Original-96/24-Master, as well as a 96/24-5.1-channel sound with full-fledged Full-Motion Video for music programmes and film soundtracks on DVD-Video.

**DTS Digital Surround:** Was developed to replace the analogue soundtracks of films with 6-channel digital soundtracks, and is now becoming popular in cinemas all over the world. DTS, Inc. has developed a home theatre system that allows you to be able to enjoy the fullness of tone and the natural spaciousness of DTS Digital Surround even at home. This system generates practically distortion-free 6-channel sound (expressed technically: a left, right and centre channel, 2 surround-channels plus a 0.1-LFE channel as subwoofer for a total of 5.1 channels). This unit includes a DTS-ES decoder, which allows a 6.1-channel playback, by adding the rear surround channel to the existing 1-channel format.

**DTS-HD High Resolution Audio:** This is a high-resolution audio technology, developed for HD media including Blu-ray Disc. Selected as an optional audio standard for Blu-ray Disc, this technology delivers sound that practically cannot be distinguished from the original, and gives a home-theatre experience. By supporting bitrates up to 6.0 Mbps for Blu-ray Disc, DTS-HD High Resolution Audio can simultaneously transmit up to 7.1 discrete channels of 24-Bit/96-kHz-audio. Furthermore, DTS-HD High Resolution Audio is fully compatible with existing multichannel audio systems in which DTS Digital Surround is integrated.

**DTS-HD Master Audio:** This is a highly developed audio technology developed for HD media, including Blu-ray Disc. Selected as an optional audio standard for Blu-ray Disc, this technology provides sound that is identical to the Studio-Master bit-for-bit.

**DTS Neo:6:** Decodes the conventional 2-channel sources for the 6-channel playback with a special decoder. This makes possible the playback with full-range channels of higher channel separation like for the playback of discrete digital signals. There are two modes available: Music mode for music sources and Cinema mode for films.

# Technical Data

## General

|                       |  |
|-----------------------|--|
| Sound Projector ID    | Item No. 69205 T/W/U00                   |
| Operating temperature | 5 °C ... 35 °C                           |
| Humidity              | 30 % ... 90 % (no condensation)          |
| Dimensions (approx.)  | 1000x225x90 mm (W x H x D)               |
| Weight                | 10.6 kg                                  |
| Electrical Data       |  |
| Power supply          | AC 220 - 240V, 50/60 Hz                  |
| Power consumption     | during operation: 55 W<br>Standby: 0.5 W |

## Amplifier

|                            |  |
|----------------------------|--|
| Maximum output power (EIA) | 40 x 2 W (1 kHz, 10% distortion factor, 4 Ohm)<br>2 x 20 W (100 Hz, 10% harmonic distortion, 3 ohms) |
| Frequency response         | 75 Hz - 20 kHz (-10 dB, Stereo mode)   |

## Decoder

|                        |  |
|------------------------|--|
| Surround formats       | Dolby Digital, Dolby Digital Plus, Dolby True HD, Dolby Digital EX, Dolby ProLogic IIx, DTS Neo 6, DTS HD Master Audio |
| Sound modes            | DTS ES matrix, DTS HD High Resolution Audio  |
| Sound field programmes | 5-Beam(2), 3-Beam, Stereo+3 Beam(2), Stereo<br>11 programmes and OFF can be selected                                   |

## Loudspeakers

|                |                             |
|----------------|-----------------------------|
| Small speakers | 40 x 4 cm cone loudspeakers |
| Bass speakers  | 2 x 11 cm cone loudspeakers |

## Inputs

|                   |  |
|-------------------|--|
| TV AUDIO IN       | analogue, 1 V, 32 kOhm, RCA socket x 2           |
| AUX AUDIO         | IN analogue, 1 V, 32 kOhm, RCA socket x 2        |
| TV DIGITAL        | IN digital, 0.5 V (p-p), 75 ohms, RCA socket x 1 |
| AUX1/2 DIGITAL IN | Optical connection x 2 (TOS-Link)                |
| VIDEO IN          | 75 Ohm, RCA socket x 1                           |
| COMPONENT         | Y/Pb/Pr, 75 ohms, RCA socket x 3                 |
| HDMI IN 1-4       | Type A, 19-pin, LVDS digital, V1.3 x4            |
| FM ANTENNA IN     | FM-antenna input, 75 ohm                         |

## Outputs

|           |                                     |
|-----------|-------------------------------------|
| VIDEO OUT | 1.0 Vp-p, 75 ohm, RCA socket x 1    |
| HDMI OUT  | Type A, 19 Pin, LVDS digital, V1.3  |
| SUB       | Subwoofer Out 1.5 V, RCA socket x 1 |

## System

|                  |                        |
|------------------|------------------------|
| Microphone input | jack socket 3.5 mm x 1 |
| Serial port      | 6-pole RJ12/ RS-232C   |
| AUDIO LINK       | 26-pole D-SUB          |

## Radio

|                 |                    |
|-----------------|--------------------|
| Reception range | 87.50 - 108.00 MHz |
|-----------------|--------------------|

## Company and editorial details

Loewe AG is a public limited company under German law with its Head Office in Kronach.

Industriestraße 11, 96317 Kronach

Issue 03.13. 3<sup>rd</sup> edition

© Loewe Opta GmbH, Kronach

All rights reserved including translation.

Design and technical specifications are subject to change without notice.

# Environment

## Environmental Protection

### Cardboard box and packaging

In line with national regulations regarding the disposal of packaging materials, we pay a fee to authorised recyclers who collect packaging from dealers. Nevertheless, we recommend that you keep the original cardboard box and the rest of the packaging materials so that the unit can, if necessary, be transported in the safest possible conditions.

### The Unit

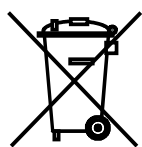

**Attention:** The EU Directive 2002/96 /EC governs the proper return, handling and recycling of used electronic appliances. Old electronic appliances must therefore be disposed of separately. Never dispose of this unit in the normal domestic waste! You can hand in your old unit free of charge at identified collection points or to your dealer if you buy a similar new unit.

Other details about return (also for non-EU countries) are available from your local authorities.

### Remote control batteries



The batteries provided contain no harmful materials such as cadmium, lead or mercury.

Regulations concerning used batteries mean that batteries may no longer be disposed of in household waste. You can dispose of used batteries free of charge at the collection points in commercial outlets. Your dealer will also have a collection point for used batteries.

# Legal notices

## Trademark rights

Manufactured under licence from Dolby Laboratories. Dolby, ProLogic and the double-D symbol are trademarks of Dolby Laboratories.

Manufactured under license of the US-Patents # 5,451,942; 5,956,674; 5,974,380; 5,978,762; 6,487,535 and other patents registered in the USA or world-wide and/or patents for which applications have been filed. DTS and the symbol are registered brands and DTS Digital Surround as well as the corresponding logo are registered trademarks of DTS, Inc. © DTS, Inc. All rights reserved.

HDMI, the HDMI logo and High-Definition Multimedia Interface are trademarks or registered trademarks of HDMI licensing LLC.

Macrovision U.S. Patent Information

Manufactured under licence from 1 Ltd. protected by world-wide patent. The logo  and "Digital Sound Projector™" are trademarks of 1 Ltd.

TruBass, SRS and the  symbol are registered trademarks of SRS Labs, Inc. TruBass technology is manufactured under licence from SRS Labs, Inc. This product was made with the support of the YAMAHA CORPORATION.

# Service

**(A)** Loewe Austria GmbH  
Parkring 12  
1010 Wien, Österreich  
Tel +43 - 810 0810 24  
Fax +43 - 1 22 88 633 - 90  
E-mail: loewe@loewe.co.at

**(AUS)**  
Audio Products Group Pty Ltd  
67 O'Riordan St  
Alexandria NSW 2015, Australia  
Tel +61 - 1300 130 492  
Fax +61 - 02 9578 0140  
E-mail: help@audioproducts.com.au

**(B NL L)**  
Loewe Opta Benelux NV/SA  
Uilenbaan 84  
2160 Wommelgem, België  
Tel +32 - 3 - 2 70 99 30  
Fax +32 - 3 - 2 71 01 08  
E-mail: ccc@loewe.be

**(BG)** Darlington Service  
193 Kn. Klementina St.  
1612 Sofia, Bulgaria  
Tel +359 - 2 9556399  
E-mail: darlington@psp-bg.com

**(CH)** Telion AG  
Rütistrasse 26  
8952 Schlieren, Schweiz  
Tel +41 - 44 732 15 11  
Fax +41 - 44 732 15 02  
E-mail: infoKD@telion.ch

**(CY)** Hadjikyriakos & Sons Ltd.  
121 Prodromos Str., P.O Box 21587  
1511 Nicosia, Cyprus  
Tel +357 - 22 87 21 11  
Fax +357 - 22 66 33 91  
E-mail: savvas@hadjikyriakos.com.cy

**(CZ)** BaSys CS s.r.o.  
Sodomkova 1478/8  
10200 Praha 10 - Hostivar,  
Česká republika  
Tel +420 234 706 700  
Fax +420 234 706 701  
E-mail: office@basys.cz

**(D)** Loewe Opta GmbH,  
Customer Care Center  
Industriestraße 11  
96317 Kronach, Deutschland  
Tel +49 9261 99-500  
Fax +49 9261 99-515  
E-mail: ccc@loewe.de

**(DK)** Kjaerulff1 Development A/S  
C.F. Tietgens Boulevard 19  
5220 Odense SØ, Denmark  
Tel +45 - 66 13 54 80  
Fax +45 - 66 13 54 10  
E-mail: info@loewe.dk

**(E)** Gaplasa S.A.  
Conde de Torroja, 25  
28022 Madrid, España  
Tel +34 - 917 48 29 60  
Fax +34 - 913 29 16 75  
E-mail: loewe@maygap.com

**(F)** Loewe France SAS  
Rue du Dépôt,  
13 Parc de l'Europe, BP 10010  
67014 Strasbourg Cédex, France  
Tel +33 - 3 - 88 79 72 50  
Fax +33 - 3 - 88 79 72 59  
E-mail: loewe.france@loewe-fr.com

**(FIN)** Karevox Oy  
Museokatu 36  
00100 Helsinki, Finland  
Tel +358 - 9 44 56 33  
E-mail: kare@haloradio.fi

**(GB IRL)** Loewe UK Limited  
1st Floor, 237A Kensington High St  
London  
W8 6SA, UK  
Tel +44 - (0) 207 368 1100  
Fax +44 - (0) 207 368 1101  
E-mail: enquiries@loewe-uk.com

**(GR RO)** Issagogiki Emboriki  
Ellados S.A.  
321 Mesogion Av.  
152 31 Chalandri-Athens, Hellas  
Tel +30 - 210 672 12 00  
Fax +30 - 210 674 02 04  
E-mail: christina\_argyropoulou@  
isembel.gr

**(H)** Basys Magyarorszagi KFT  
Tó park u.9.  
2045 Törökbálint, Magyar  
Tel +36 - 2341 56 37 (121)  
Fax +36 - 23 41 51 82  
E-mail: erteakesites@basys.hu

**(HK CN)** Galerien Und PartnerPlus  
King's Tower 28/F, 111 King Lam Street  
Kowloon, Hong Kong  
Tel +852 - 27 77 89 88  
Fax +852 - 23 10 08 08  
E-mail: service@loewe-cn.com

**(HR)** Plug&Play Ltd.  
Bednjanska 8, 10000 Zagreb  
Hrvatska (Kroatia)  
Tel +385 1 4929 683  
Fax +385 1 4929 682  
E-mail: info@loewe.hr  
**(I)** Loewe Italiana S.r.l.  
Via Monte Baldo, 14/P - 14/N  
37069 Dossobuono di Villafranca di  
Verona  
Tel +39 - 045 82 51 690  
Fax +39 - 045 82 51 622  
E-mail: info@loewe.it

**(IL)**  
Clear electronic entertainment Ltd  
13 Noah Mozes St.  
Agish Ravad Building  
Tel Aviv 67442, Israel  
Tel +972 - 3 - 6091100  
Fax +972 - 3 - 6092200  
E-mail: info@loewe.co.il

**(IND)** Navshiv Retail Pvt. Ltd.  
Block D, Plot No. 7 Shanti Kunj  
Vasant Kunj  
New Delhi - 110070, India  
Tel +91 11 47 65 55 00  
Fax +91 11 47 67 67 15  
E-Mail: admin@navshiv.com

**(IR)** MiMoRa HOLDING CO.  
N0 1001, Afra Tower  
Parsa St. Fereshteh  
Tehran, Iran  
Tel + 98 921 344 0521  
E-Mail: s.zarandooz@gmail.com

**(KSA)** Salem Agencies & Services Co.  
Hamad Al Haqueel Street, Rawdah,  
Jeddah 21413  
Kingdom of Saudi Arabia  
Tel +966 (2) 665 4616  
Fax +966 (2) 660 7864  
E-mail: hkurjian@aol.com

**(LV EST)** Kpartners, SIA  
A.Čaka iela 80  
Rīga, LV-1011, Latvia  
Tel +3 71 - 67 29 29 59  
Fax +3 71 - 67 31 05 68  
E-mail: olga@dom332.lv

**(LT)** A Cappella Ltd.  
Ausros Vartu 5, Pasazo skg.  
01129 Vilnius, Lithuania  
Tel +370 - 52 12 22 96  
Fax +370 - 52 62 66 81  
E-mail: info@loewe.lt

**(M)** Doneo Co. Ltd  
34/36 Danny Cremona Street  
Hamrun, HMR1514, Malta  
Tel +356 - 21 - 22 53 81  
Fax +356 - 21 - 23 07 35  
E-mail: service@doneo.com.mt

**(MA)** Somara S.A.  
377, Rue Mustapha El Maani  
20000 Casablanca, Morocco  
Tel +212 - 22 22 03 08  
Fax +212 - 22 26 00 06  
E-mail: somara@somara.ma

**(N)** Premium Consumer Electronics as  
Østre Kullerød 5  
3241 Sandefjord, Norge  
Tel +47 - 33 29 30 40  
Fax +47 - 33 44 60 44  
E-mail: loewe@loewe.no

**(NZ)** Audio Products Group Pty Ltd  
67 O'Riordan St  
Alexandria NSW 2015, Australia  
Tel 0800 174 781  
Fax +61 - 02 9578 0140  
E-mail: help@audioproducts.com.au

**(P)** Mayro Magnetics Portugal, Lda.  
Rua Professor Henrique de Barros  
Edifício Sagres, 2º. C  
2685-338 Prior Velho, Portugal  
Tel +351 - 21 942 78 30  
Fax +351 - 21 940 00 78  
E-mail: geral.loewe@mayro.pt

**(PL)** Tele Radio Video  
Ul. Boh. Getta Warszawskiego 18  
81-609 Gdynia  
Tel. 58 624-50-09  
E-Mail: loewe@trv.com.pl

**(RUS)** Service Center Loewe  
Aptekarsky per.4 podjezd 5A  
105005 Moscow, Russia  
Tel +7 - 499 940 42 32 ( ext. 454 )  
Fax +7 - 495 730 78 01  
E-mail: service@loewe-cis.ru

**(S)** Kjaerulff 1 AB  
Ridbanegatan 4, Box 9076  
200 39 Malmö, Sverige  
Tel +46 - 4 06 79 74 00  
Fax +46 - 4 06 79 74 01  
E-mail: loewe@loewe.se

**(SG)** Atlas Sound & Vision Pte Ltd  
10 Winstedt Road #01-18  
Singapore 227977  
Tel +65 - 6334 9320  
Fax +65 - 6339 1615  
E-mail: service@atlas-sv.com

**(SK)** BaSys SK, s.r.o.  
Stará Vajnorská 37/C  
83104 Bratislava, Slovakia  
Tel + 421 2 49 10 66 18  
Fax + 421 2 49 10 66 33  
E-mail: loewe@basys.sk

**(TR)** SERVISPLUS GENEL MERKEZ  
ÖRNEK MAH. ATES SOK. NO:1  
34704 ATASEHIR, ISTANBUL, TÜRKIYE  
Tel +90 - 216 315 39 00  
Fax +90 - 216 315 49 50  
E-mail: info@servisplus.com.tr

**(UAE)** Dubai Audio Center  
P.O. Box 32836, Sheikh Zayed Road  
Dubai, UAE  
Tel +971 - 4 343 14 41  
Fax +971 - 4 343 77 48  
E-mail: service@dubaiaudio.com